

## ■ Features

- Colorless transparency lens type
- $\phi 5\text{mm}$ (T-1 $\frac{3}{4}$ ) all plastic mold type
- High luminosity
- ESD Class(Mil Std-883d Method 3015.7) based on Human Body Model(HBM) : Class 3

## ■ Outline dimensions

(unit : mm)

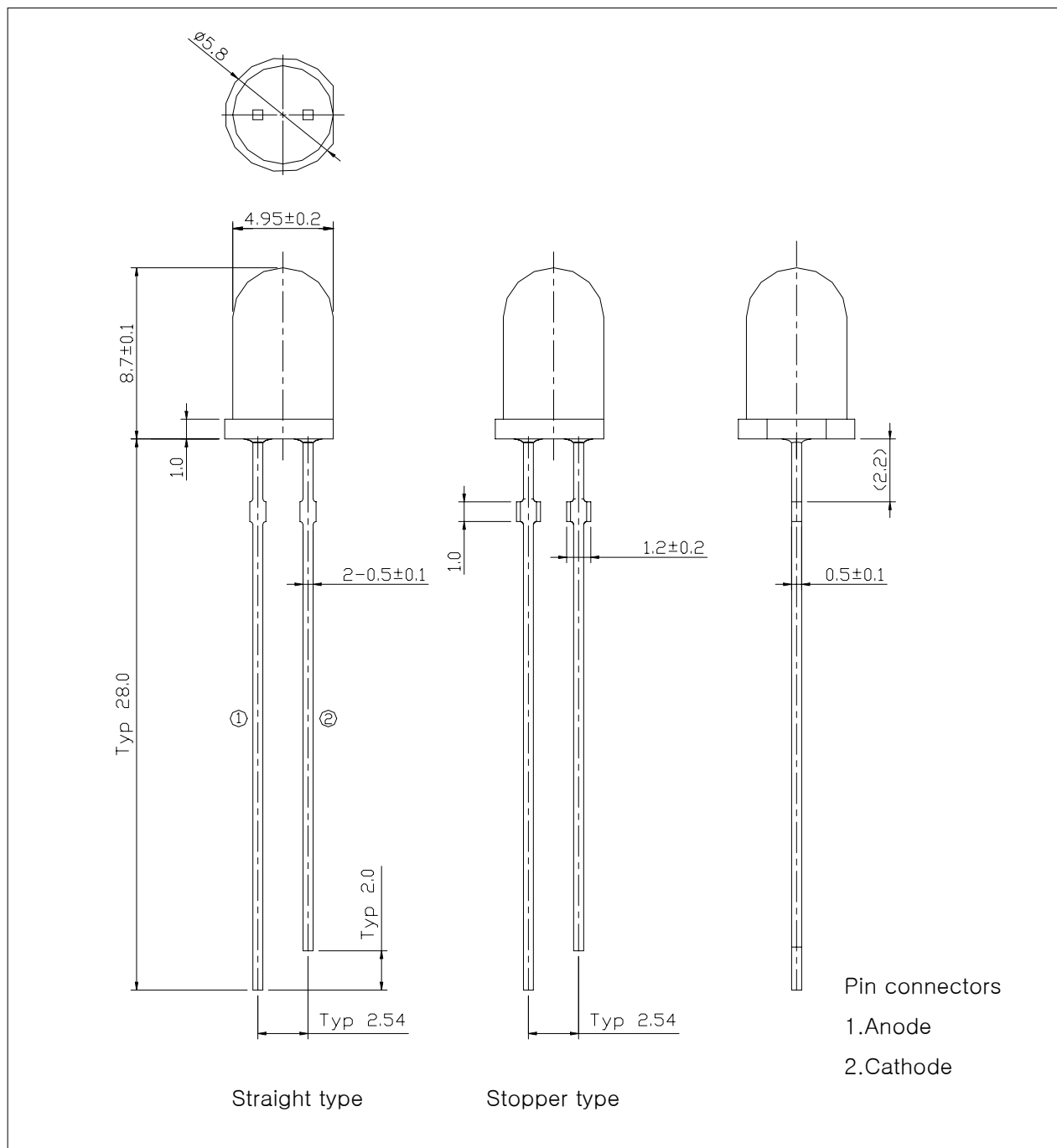

## ■ Absolute maximum ratings

Characteristic	Symbol	Ratings	Unit
Power dissipation	$P_D$	120	mW
Forward Current	$I_F$	30	mA
* <sup>1</sup> Peak Forward Current	$I_{FP}$	100	mA
Reverse Voltage	$V_R$	5	V
Operating Temperature	$T_{opr}$	-30~85	°C
Storage Temperature	$T_{stg}$	-40~100	°C
* <sup>2</sup> Soldering Temperature	$T_{sol}$	260°C for 3 seconds	

\*1. Duty ratio 1/10, Pulse Width 10msec

\*2. Keep the distance more than 2.0mm from PCB to the bottom of LED package

## ■ Electrical – Optical characteristics

(Ta=25°C)

Characteristic	Symbol	Test Condition	Min.	Typ.	Max.	Unit
ESD Check Forward Voltage	$V_{F2}$	$I_F=10\mu A$	2.0	-	-	V
Reverse Current	$I_R$	$V_R=5V$	-	-	50	uA
Dominant Wavelength	$\lambda_d$	$I_F=20mA$	500	-	510	nm
Spectrum Bandwidth	$\Delta\lambda$	$I_F=20mA$	-	35	-	nm
* <sup>3</sup> Half Angle	$\theta_{1/2}$	$I_F=20mA$	-	±17	-	deg

\*3.  $\theta_{1/2}$  is the off-axis angle where the luminous intensity is 1/2 the peak intensity

## ■ Dominant Wavelength

(Ta=25°C)

W <sub>D</sub> RANK	Test Condition	Min.	Typ.	Max.	Unit
A	I <sub>F</sub> = 20mA	500	–	505	nm
B		505	–	510	

\* Wavelength are tested at a current pulse duration 25ms and an accuracy of ±1 nm.

## ■ Luminous intensity ranks

(Ta=25°C)

I <sub>v</sub> RANK	Test Condition	Min.	Typ.	Max.	Unit
S	I <sub>F</sub> = 20mA	3400	–	4800	mcd
T		4800	–	6700	
U		6700	–	9400	
V		9400	–	13000	

\* Luminous intensity is tested at a current pulse duration of 25 ms and an accuracy of ±11%.

Intensity Measured : 0.01sr(CIE. LED\_B)

## ■ Forward Voltage ranks

(Ta=25°C)

V <sub>f</sub> RANK	Test Condition	Min.	Typ.	Max.	Unit
1	I <sub>F</sub> = 20mA	–	3.1	3.3	V
2		3.3	3.5	3.8	

\* Voltages are tested at a current pulse duration of 1 ms and an accuracy of ±0.1V.

## ■ Precautions On LED using

\* To avoid optical difference, Please do not mix differently-ranked product.

## ■ Characteristic Diagrams

Fig. 1 IF-VF

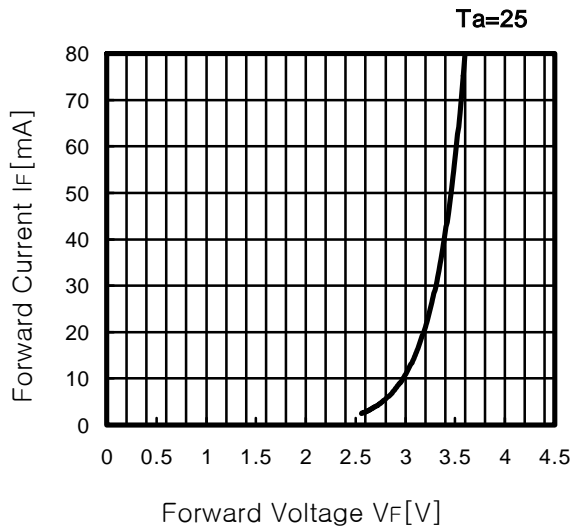

Fig. 2 Iv-IF

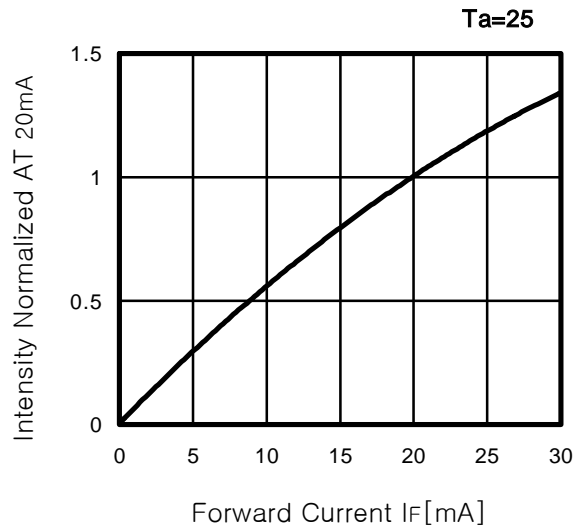

Fig.3 Max. Permissible Forward Current

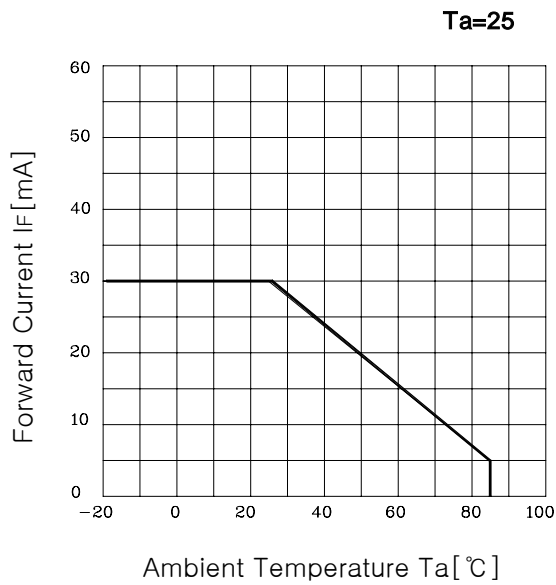
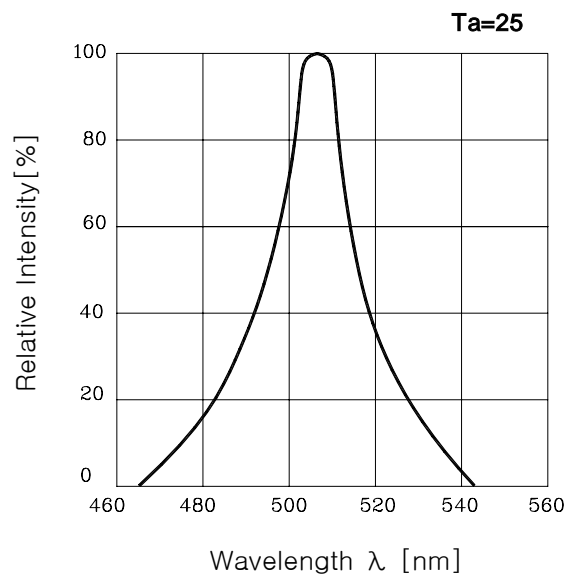
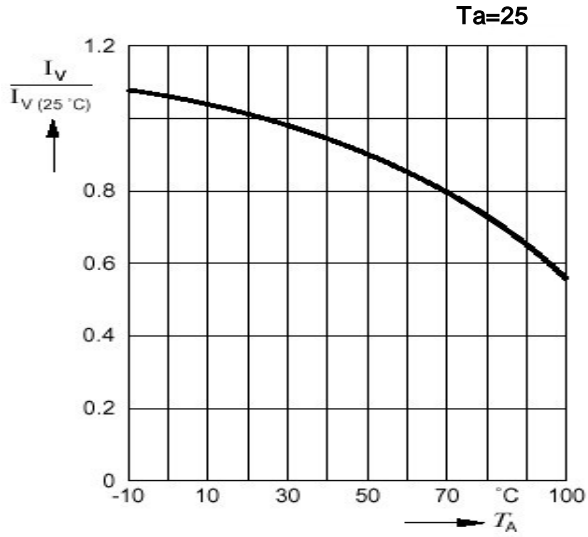

Fig. 3 Spectrum Distribution



**Fig. 4 Relative Intensity - Ta**



**Fig. 5 Radiation Diagram**

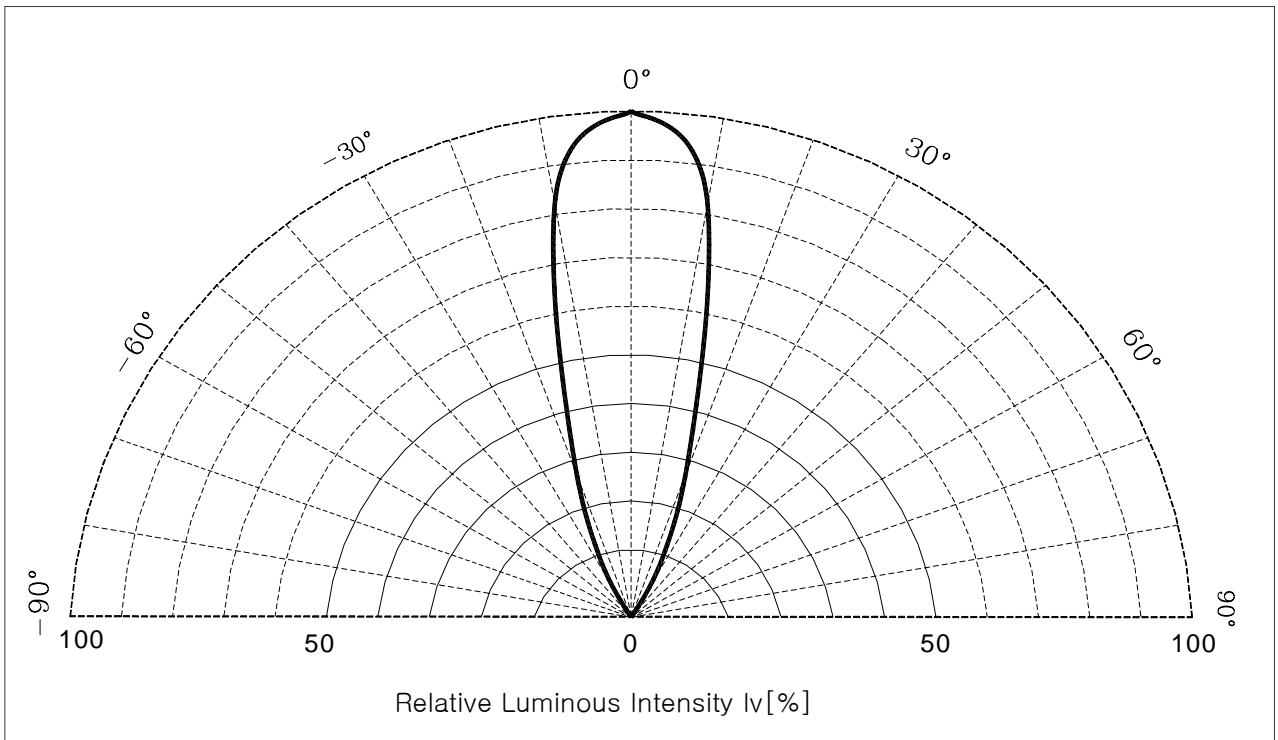

■ Revision history sheet

Spec NO.			
Title	Specification for Approval		
Times	Date	Summary of revision	Remarks
1	2001. 07. 15	신규제정	
2	2003. 02. 26	Format 변경	
3	2004. 06. 03	lv Rank 변경	