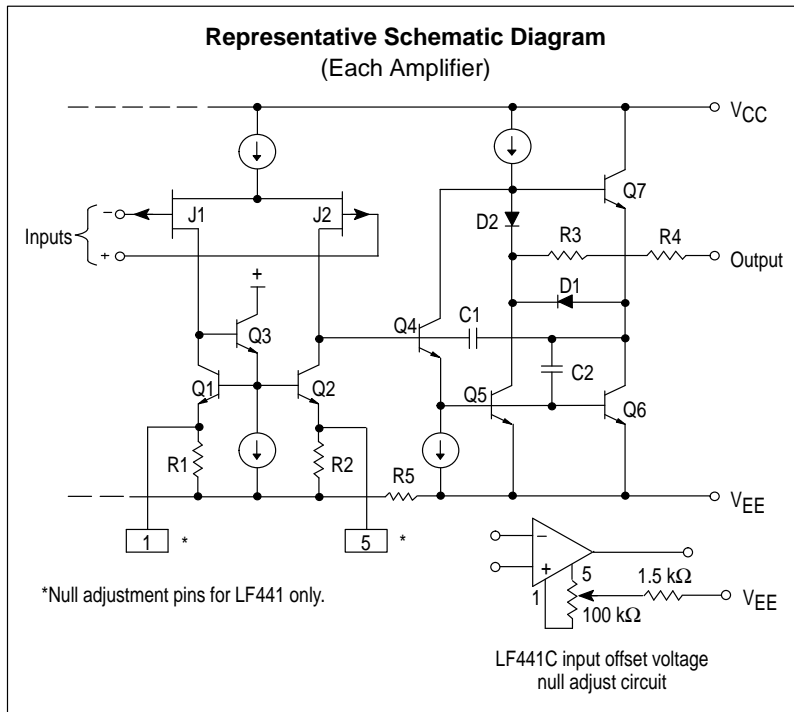


# Low Power JFET Input Operational Amplifiers

These JFET input operational amplifiers are designed for low power applications. They feature high input impedance, low input bias current and low input offset current. Advanced design techniques allow for higher slew rates, gain bandwidth products and output swing. The LF441C device provides for the external null adjustment of input offset voltage.

These devices are specified over the commercial temperature range. All are available in plastic dual in-line and SOIC packages.

- Low Supply Current: 200  $\mu$ A/Amplifier
- Low Input Bias Current: 5.0 pA
- High Gain Bandwidth: 2.0 MHz
- High Slew Rate: 6.0 V/ $\mu$ s
- High Input Impedance:  $10^{12} \Omega$
- Large Output Voltage Swing:  $\pm 14$  V
- Output Short Circuit Protection



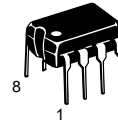
## ORDERING INFORMATION

Device	Function	Operating Temperature Range	Package
LF441CD LF441CN	Single	$T_A = 0^\circ$ to $+70^\circ\text{C}$	SO-8 Plastic DIP
LF442CD LF442CN	Dual		SO-8 Plastic DIP
LF444CD LF444CN	Quad		SO-14 Plastic DIP

# LF441C LF442C LF444C

## LOW POWER JFET INPUT OPERATIONAL AMPLIFIERS

### SEMICONDUCTOR TECHNICAL DATA

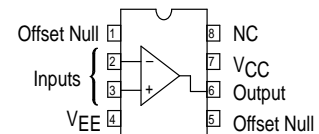


**N SUFFIX**  
PLASTIC PACKAGE  
CASE 626

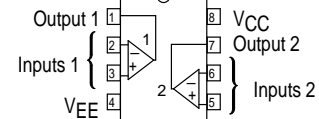


**D SUFFIX**  
PLASTIC PACKAGE  
CASE 751  
(SO-8)

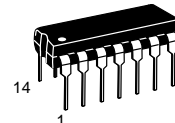
### PIN CONNECTIONS



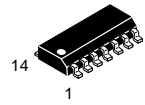
(Single, Top View)



(Dual, Top View)

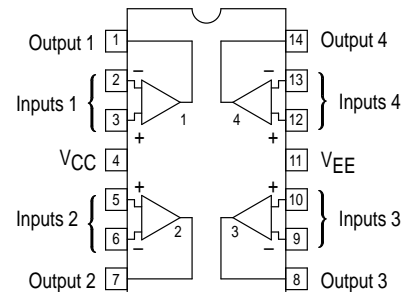


**N SUFFIX**  
PLASTIC PACKAGE  
CASE 646



**D SUFFIX**  
PLASTIC PACKAGE  
CASE 751A  
(SO-14)

### PIN CONNECTIONS



(Quad, Top View)

# LF441C LF442C LF444C

## MAXIMUM RATINGS

Rating	Symbol	Value	Unit
Supply Voltage (from $V_{CC}$ to $V_{EE}$ )	$V_S$	+36	V
Input Differential Voltage Range (Note 1)	$V_{IDR}$	$\pm 30$	V
Input Voltage Range (Notes 1 and 2)	$V_{IR}$	$\pm 15$	V
Output Short Circuit Duration (Note 3)	$t_{SC}$	Indefinite	sec
Operating Junction Temperature (Note 3)	$T_J$	+150	$^{\circ}\text{C}$
Storage Temperature Range	$T_{stg}$	-60 to +150	$^{\circ}\text{C}$

- NOTES:**
- Differential voltages are at the noninverting input terminal with respect to the inverting input terminal.
  - The magnitude of the input voltage must never exceed the magnitude of the supply or 15 V, whichever is less.
  - Power dissipation must be considered to ensure maximum junction temperature ( $T_J$ ) is not exceeded (see Figure 1).

## DC ELECTRICAL CHARACTERISTICS ( $V_{CC} = +15\text{ V}$ , $V_{EE} = -15\text{ V}$ , $T_A = 0^{\circ}$ to $70^{\circ}\text{C}$ , unless otherwise noted.)

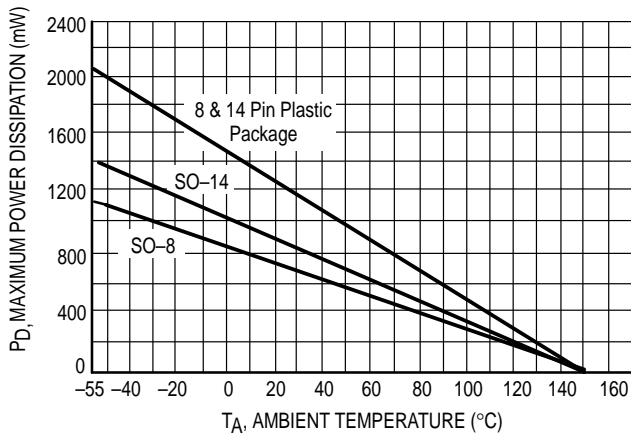
Characteristic	Symbol	Min	Typ	Max	Unit
Input Offset Voltage ( $R_S = 10\text{ k}\Omega$ , $V_O = 0\text{ V}$ ) Single: $T_A = +25^{\circ}\text{C}$ $T_A = 0^{\circ}$ to $+70^{\circ}\text{C}$ Dual: $T_A = +25^{\circ}\text{C}$ $T_A = 0^{\circ}$ to $+70^{\circ}\text{C}$ Quad: $T_A = +25^{\circ}\text{C}$ $T_A = 0^{\circ}$ to $+70^{\circ}\text{C}$	$V_{IO}$	-	3.0	5.0	mV
Average Temperature Coefficient of Offset Voltage ( $R_S = 10\text{ k}\Omega$ , $V_O = 0\text{ V}$ )	$\Delta V_{IO}/\Delta T$	-	10	-	$\mu\text{V}/^{\circ}\text{C}$
Input Offset Current ( $V_{CM} = 0\text{ V}$ , $V_O = 0\text{ V}$ ) $T_A = +25^{\circ}\text{C}$ $T_A = 0^{\circ}$ to $+70^{\circ}\text{C}$	$I_{IO}$	-	0.5	50	pA nA
Input Bias Current ( $V_{CM} = 0\text{ V}$ , $V_O = 0\text{ V}$ ) $T_A = +25^{\circ}\text{C}$ $T_A = 0^{\circ}$ to $+70^{\circ}\text{C}$	$I_{IB}$	-	3.0	100	pA nA
Common Mode Input Voltage Range ( $T_A = +25^{\circ}\text{C}$ )	$V_{ICR}$	-11	+14.5 -12	+11 -	V
Large Signal Voltage Gain ( $V_O = \pm 10\text{ V}$ , $R_L = 10\text{ k}\Omega$ ) $T_A = +25^{\circ}\text{C}$ $T_A = 0^{\circ}$ to $+70^{\circ}\text{C}$	$A_{VOL}$	25 15	60 -	- -	V/mV
Output Voltage Swing ( $R_L = 10\text{ k}\Omega$ )	$V_{O+}$ $V_{O-}$	+12 -	+14 -14	- -12	V
Common Mode Rejection ( $R_S \leq 10\text{ k}\Omega$ , $V_{CM} = V_{ICR}$ , $V_O = 0\text{ V}$ )	CMR	70	86	-	dB
Power Supply Rejection ( $R_S = 100\ \Omega$ , $V_{CM} = 0\text{ V}$ , $V_O = 0\text{ V}$ )	PSR	70	84	-	dB
Power Supply Current (No Load, $V_O = 0\text{ V}$ ) Single Dual Quad	$I_D$	- - -	200 400 800	250 500 1000	$\mu\text{A}$

# LF441C LF442C LF444C

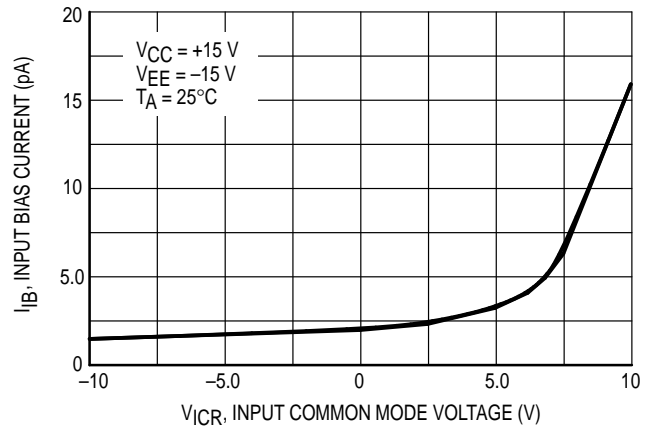
**AC ELECTRICAL CHARACTERISTICS** ( $V_{CC} = +15\text{ V}$ ,  $V_{EE} = -15\text{ V}$ ,  $T_A = +25^\circ\text{C}$ , unless otherwise noted.)

Characteristic	Symbol	Min	Typ	Max	Unit
Slew Rate ( $V_{in} = -10\text{ V to } +10\text{ V}$ , $R_L = 10\text{ k}\Omega$ , $C_L = 10\text{ pF}$ , $A_V = +1.0$ )	SR	0.6	6.0	–	V/ $\mu\text{s}$
Settling Time ( $A_V = -1.0$ , $R_L = 10\text{ k}\Omega$ , $V_O = 0\text{ V to } +10\text{ V}$ )	$t_s$	–	1.6 2.2	–	$\mu\text{s}$
Gain Bandwidth Product ( $f = 200\text{ kHz}$ )	GBW	0.6	2.0	–	MHz
Equivalent Input Noise Voltage ( $R_S = 100\ \Omega$ , $f = 1.0\text{ kHz}$ )	$e_n$	–	47	–	nV/ $\sqrt{\text{Hz}}$
Equivalent Input Noise Current ( $f = 1.0\text{ kHz}$ )	$i_n$	–	0.01	–	pA/ $\sqrt{\text{Hz}}$
Input Resistance	$R_i$	–	$10^{12}$	–	$\Omega$
Channel Separation ( $f = 1.0\text{ Hz to } 20\text{ kHz}$ )	CS	–	120	–	dB

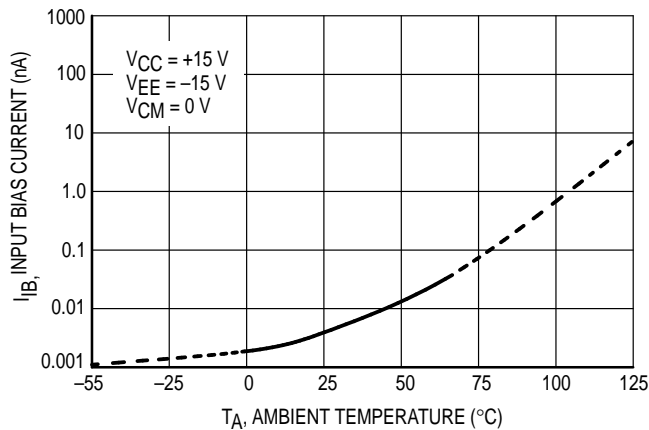
**Figure 1. Maximum Power Dissipation versus Temperature for Package Variations**



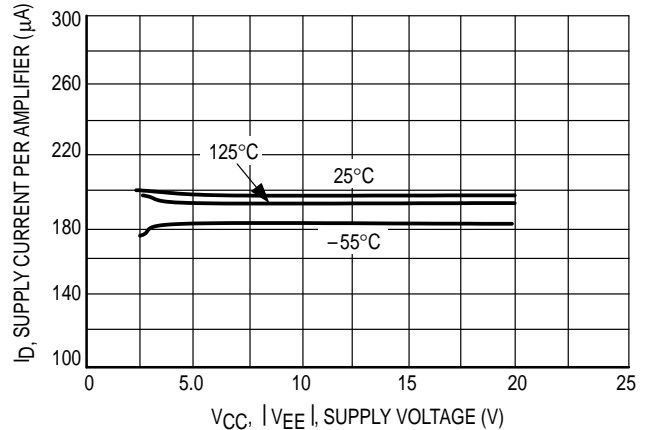
**Figure 2. Input Bias Current versus Input Common Mode Voltage**



**Figure 3. Input Bias Current versus Temperature**

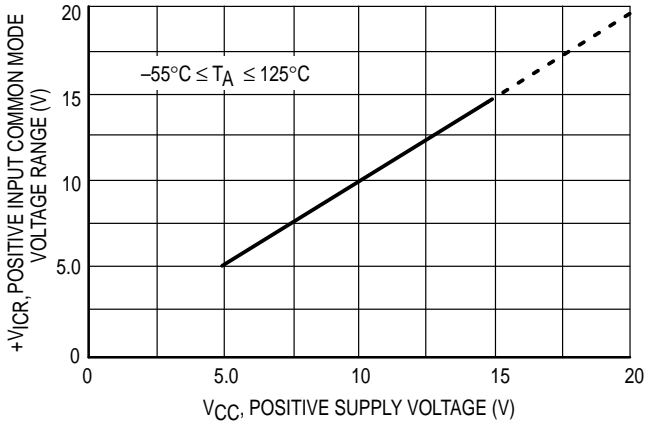


**Figure 4. Supply Current versus Supply Voltage**

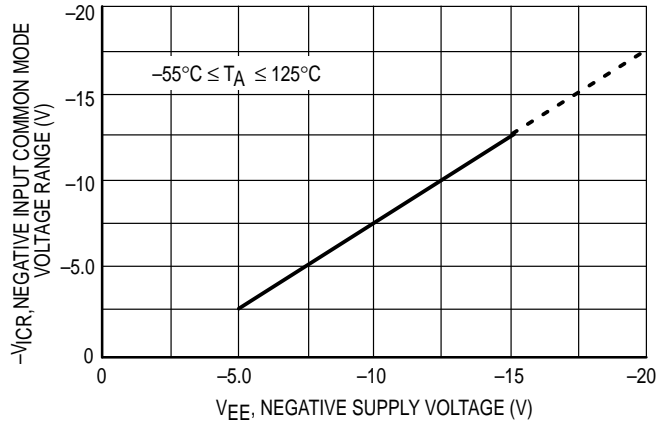


# LF441C LF442C LF444C

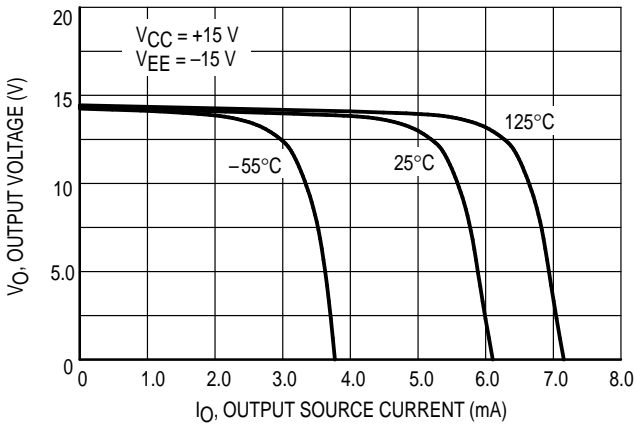
**Figure 5. Positive Input Common Mode Voltage Range versus Positive Supply Voltage**



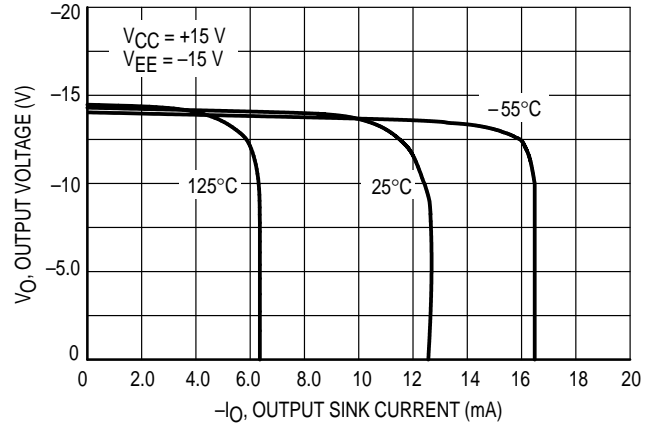
**Figure 6. Negative Input Common Mode Voltage Range versus Negative Supply Voltage**



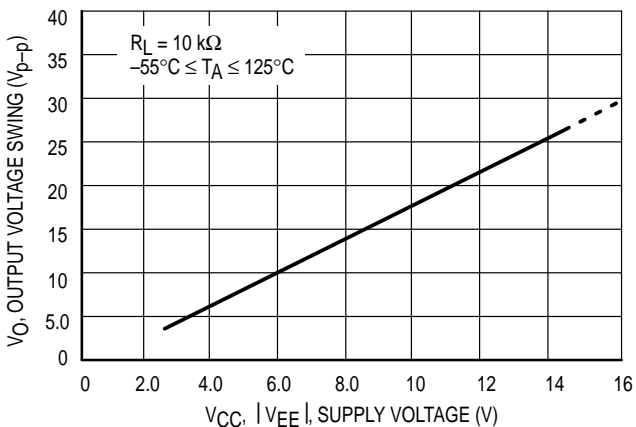
**Figure 7. Output Voltage versus Output Source Current**



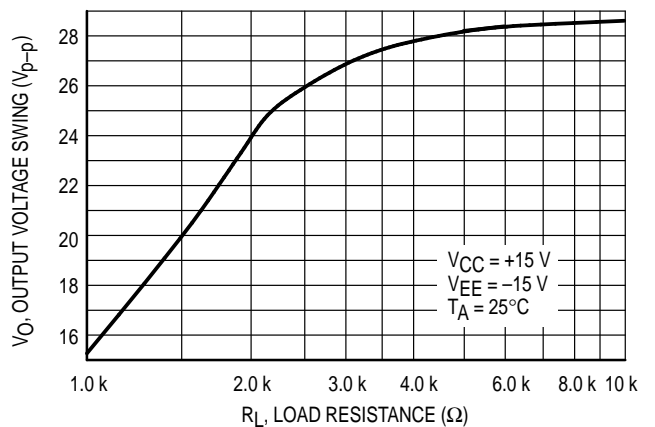
**Figure 8. Output Voltage versus Output Sink Current**



**Figure 9. Output Voltage Swing versus Supply Voltage**

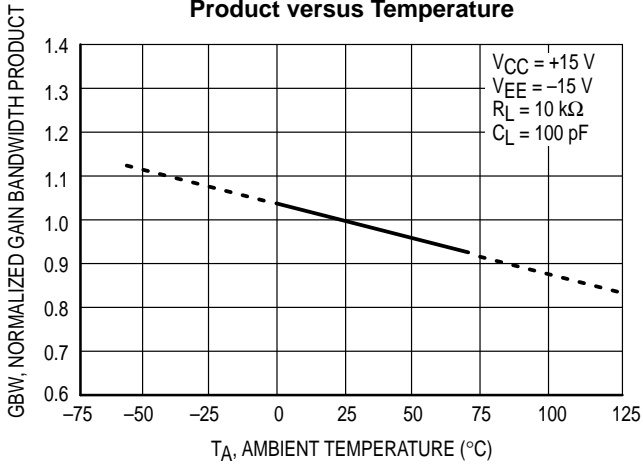


**Figure 10. Output Voltage Swing versus Load Resistance**

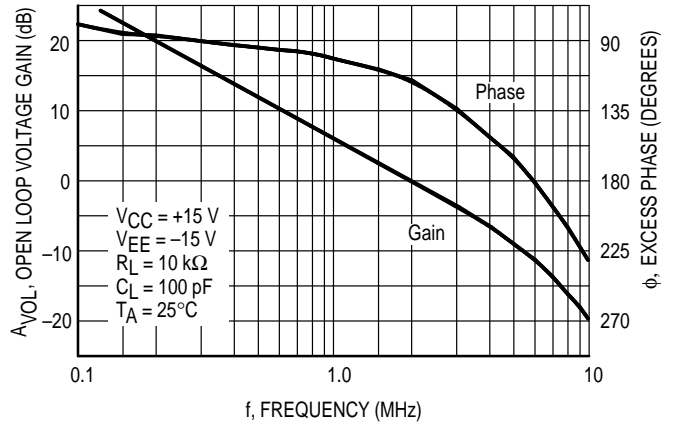


# LF441C LF442C LF444C

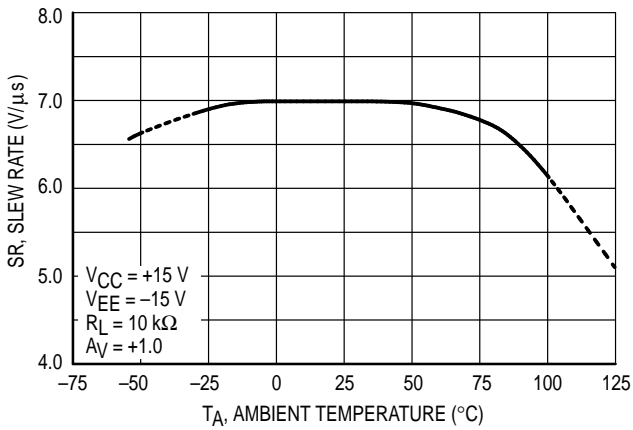
**Figure 11. Normalized Gain Bandwidth Product versus Temperature**



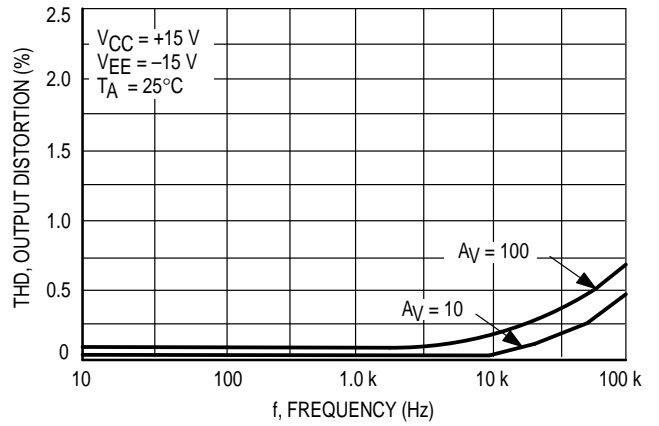
**Figure 12. Open Loop Voltage Gain and Phase versus Frequency**



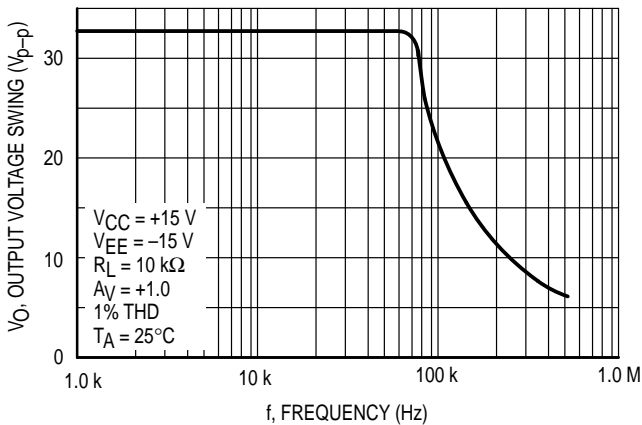
**Figure 13. Slew Rate versus Temperature**



**Figure 14. Total Output Distortion versus Frequency**



**Figure 15. Output Voltage Swing versus Frequency**



**Figure 16. Open Loop Voltage Gain versus Frequency**

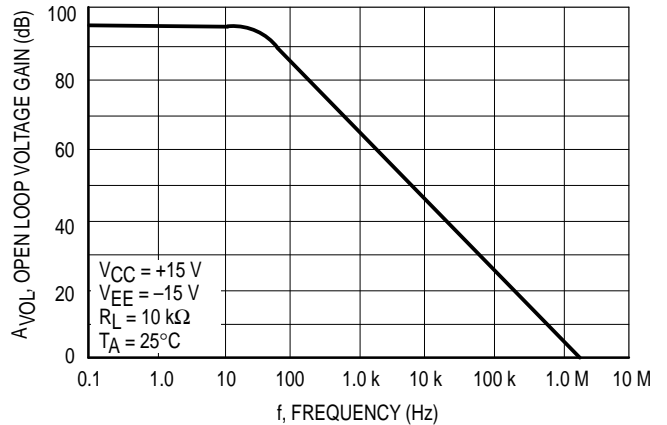


Figure 17. Common Mode Rejection versus Frequency

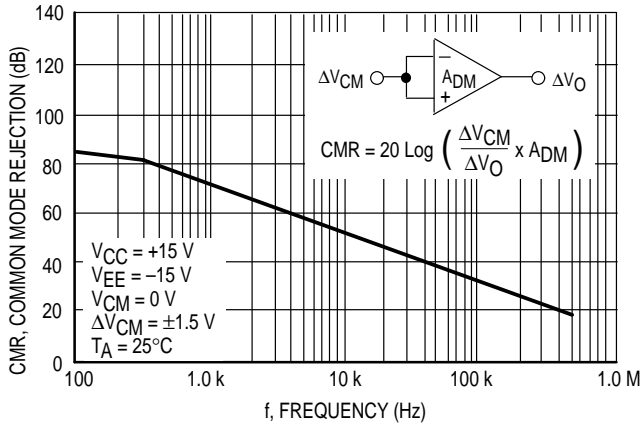


Figure 18. Power Supply Rejection versus Frequency

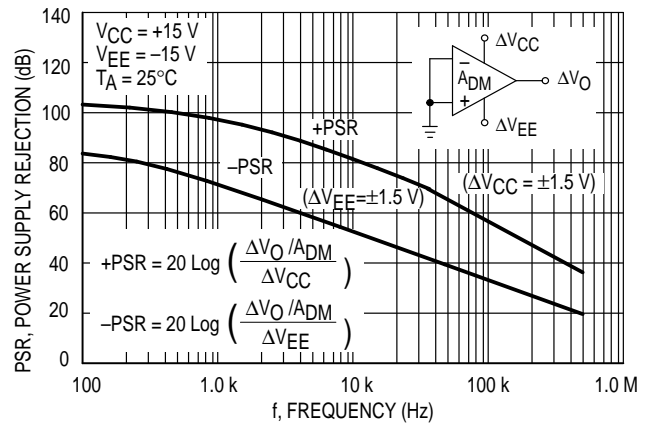


Figure 19. Input Noise Voltage versus Frequency

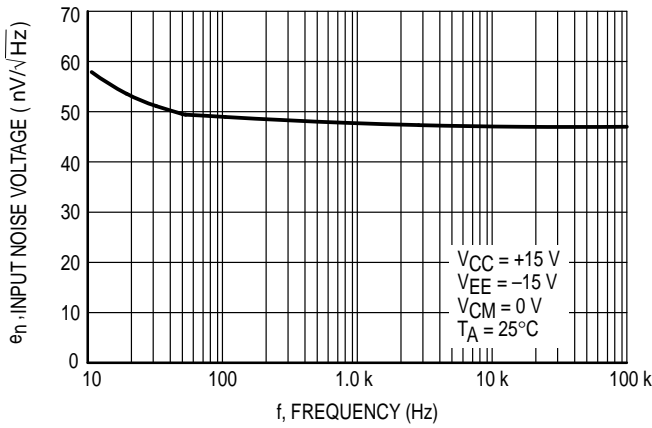


Figure 20. Open Loop Voltage Gain versus Supply Voltage

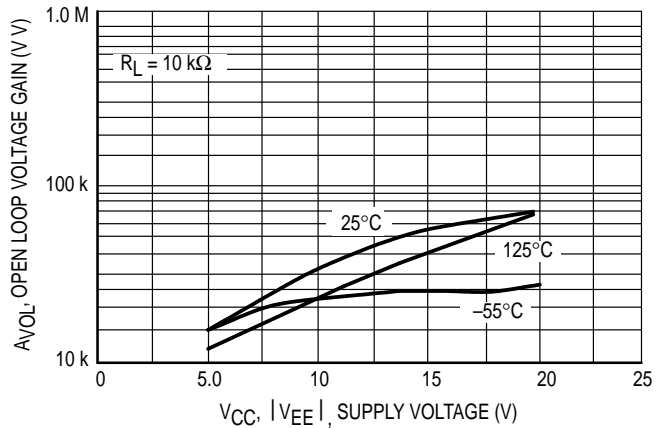


Figure 21. Output Impedance versus Frequency

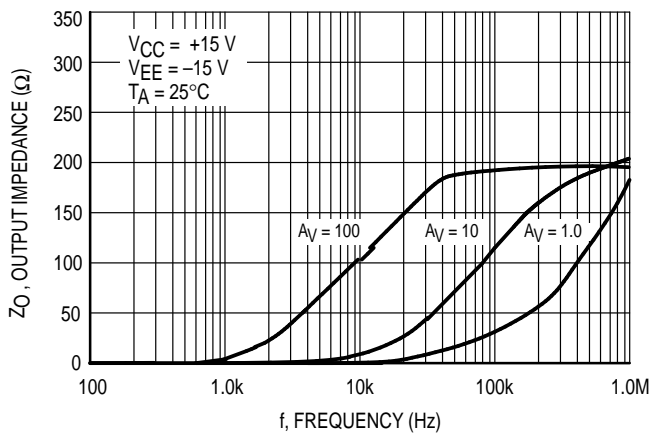
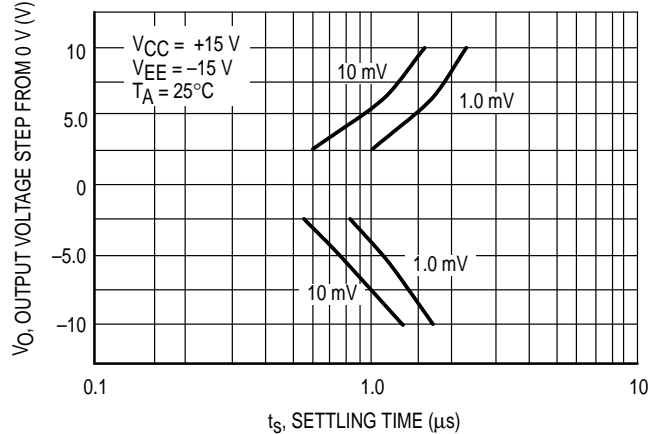


Figure 22. Inverter Settling Time



# LF441C LF442C LF444C

## SMALL SIGNAL RESPONSE

Figure 23. Inverting

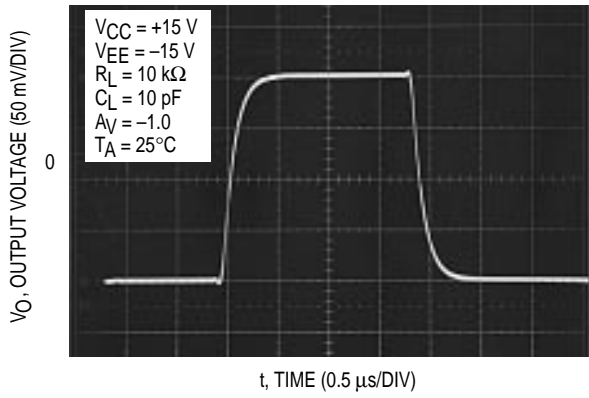
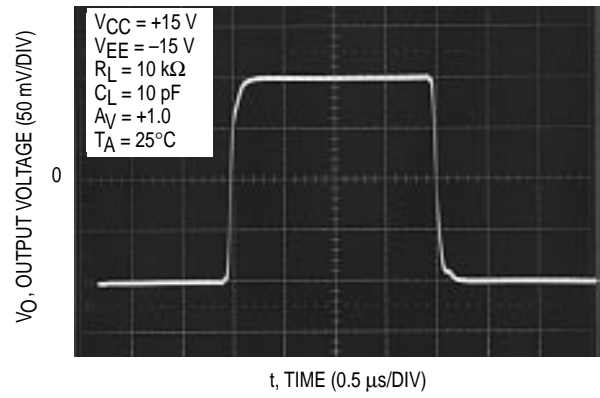


Figure 24. Noninverting



## LARGE SIGNAL RESPONSE

Figure 25. Inverting

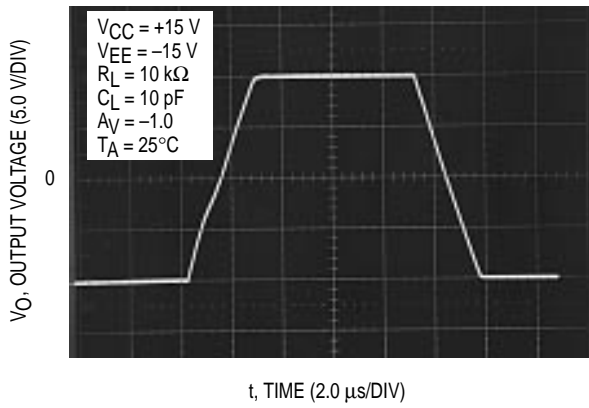
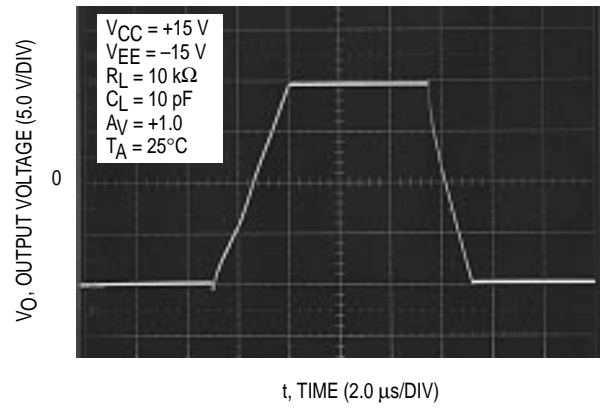


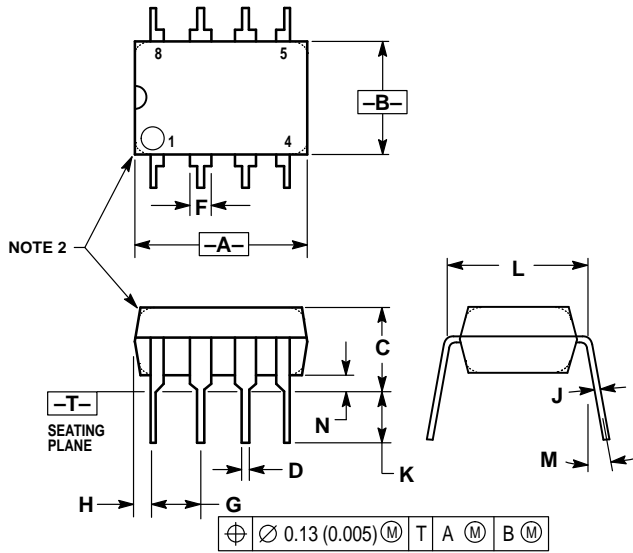
Figure 26. Noninverting



# LF441C LF442C LF444C

## OUTLINE DIMENSIONS

### N SUFFIX PLASTIC PACKAGE CASE 626-05 ISSUE K

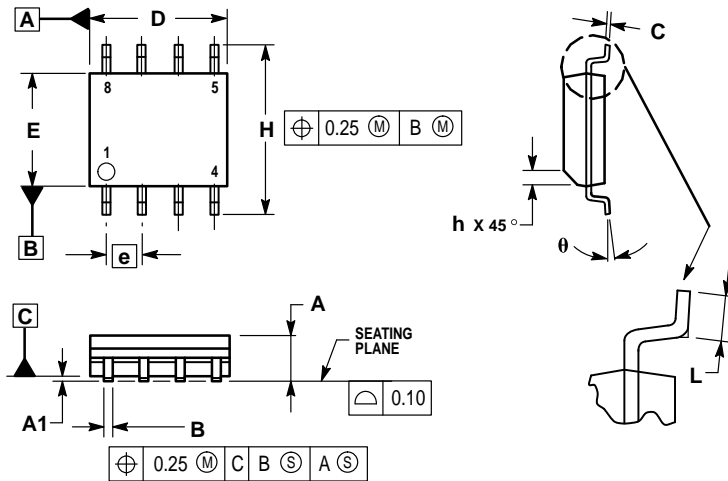


NOTES:

1. DIMENSION L TO CENTER OF LEAD WHEN FORMED PARALLEL.
2. PACKAGE CONTOUR OPTIONAL (ROUND OR SQUARE CORNERS).
3. DIMENSIONING AND TOLERANCING PER ANSI Y14.5M, 1982.

DIM	MILLIMETERS		INCHES	
	MIN	MAX	MIN	MAX
A	9.40	10.16	0.370	0.400
B	6.10	6.60	0.240	0.260
C	3.94	4.45	0.155	0.175
D	0.38	0.51	0.015	0.020
F	1.02	1.78	0.040	0.070
G	2.54 BSC		0.100 BSC	
H	0.76	1.27	0.030	0.050
J	0.20	0.30	0.008	0.012
K	2.92	3.43	0.115	0.135
L	7.62 BSC		0.300 BSC	
M	10°		10°	
N	0.76	1.01	0.030	0.040

### D SUFFIX PLASTIC PACKAGE CASE 751-05 (SO-8) ISSUE R



NOTES:

1. DIMENSIONING AND TOLERANCING PER ASME Y14.5M, 1994.
2. DIMENSIONS ARE IN MILLIMETERS.
3. DIMENSION D AND E DO NOT INCLUDE MOLD PROTRUSION.
4. MAXIMUM MOLD PROTRUSION 0.15 PER SIDE.
5. DIMENSION B DOES NOT INCLUDE MOLD PROTRUSION. ALLOWABLE DAMBAR PROTRUSION SHALL BE 0.127 TOTAL IN EXCESS OF THE B DIMENSION AT MAXIMUM MATERIAL CONDITION.

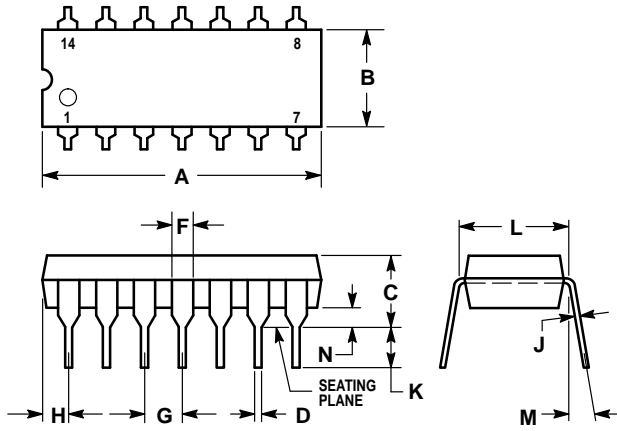
DIM	MILLIMETERS	
	MIN	MAX
A	1.35	1.75
A1	0.10	0.25
B	0.35	0.49
C	0.18	0.25
D	4.80	5.00
E	3.80	4.00
e	1.27 BSC	
H	5.80	6.20
h	0.25	0.50
L	0.40	1.25
θ	0°	7°



# LF441C LF442C LF444C

## OUTLINE DIMENSIONS

### N SUFFIX PLASTIC PACKAGE CASE 646-06 ISSUE L

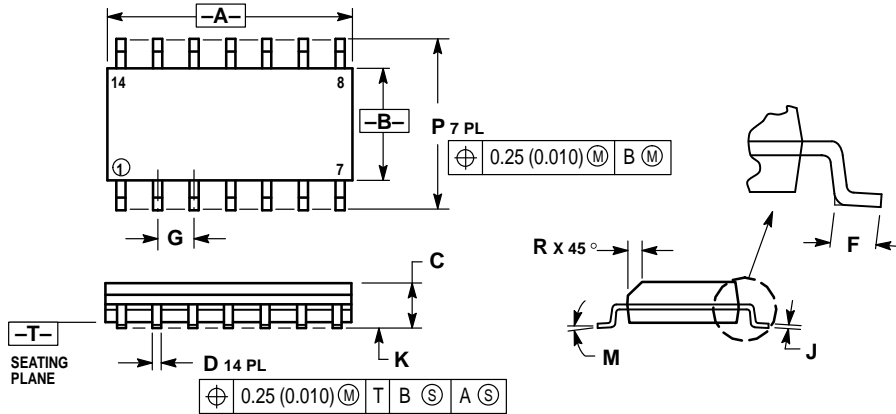


NOTES:

- LEADS WITHIN 0.13 (0.005) RADIUS OF TRUE POSITION AT SEATING PLANE AT MAXIMUM MATERIAL CONDITION.
- DIMENSION L TO CENTER OF LEADS WHEN FORMED PARALLEL.
- DIMENSION B DOES NOT INCLUDE MOLD FLASH.
- ROUNDED CORNERS OPTIONAL.

DIM	INCHES		MILLIMETERS	
	MIN	MAX	MIN	MAX
A	0.715	0.770	18.16	19.56
B	0.240	0.260	6.10	6.60
C	0.145	0.185	3.69	4.69
D	0.015	0.021	0.38	0.53
F	0.040	0.070	1.02	1.78
G	0.100 BSC		2.54 BSC	
H	0.052	0.095	1.32	2.41
J	0.008	0.015	0.20	0.38
K	0.115	0.135	2.92	3.43
L	0.300 BSC		7.62 BSC	
M	0°	10°	0°	10°
N	0.015	0.039	0.39	1.01

### D SUFFIX PLASTIC PACKAGE CASE 751A-03 (SO-14) ISSUE F




NOTES:

- DIMENSIONING AND TOLERANCING PER ANSI Y14.5M, 1982.
- CONTROLLING DIMENSION: MILLIMETER.
- DIMENSIONS A AND B DO NOT INCLUDE MOLD PROTRUSION.
- MAXIMUM MOLD PROTRUSION 0.15 (0.006) PER SIDE.
- DIMENSION D DOES NOT INCLUDE DAMBAR PROTRUSION. ALLOWABLE DAMBAR PROTRUSION SHALL BE 0.127 (0.005) TOTAL IN EXCESS OF THE D DIMENSION AT MAXIMUM MATERIAL CONDITION.

DIM	MILLIMETERS		INCHES	
	MIN	MAX	MIN	MAX
A	8.55	8.75	0.337	0.344
B	3.80	4.00	0.150	0.157
C	1.35	1.75	0.054	0.068
D	0.35	0.49	0.014	0.019
F	0.40	1.25	0.016	0.049
G	1.27 BSC		0.050 BSC	
J	0.19	0.25	0.008	0.009
K	0.10	0.25	0.004	0.009
M	0°	7°	0°	7°
P	5.80	6.20	0.228	0.244
R	0.25	0.50	0.010	0.019

# LF441C LF442C LF444C

Motorola reserves the right to make changes without further notice to any products herein. Motorola makes no warranty, representation or guarantee regarding the suitability of its products for any particular purpose, nor does Motorola assume any liability arising out of the application or use of any product or circuit, and specifically disclaims any and all liability, including without limitation consequential or incidental damages. "Typical" parameters which may be provided in Motorola data sheets and/or specifications can and do vary in different applications and actual performance may vary over time. All operating parameters, including "Typicals" must be validated for each customer application by customer's technical experts. Motorola does not convey any license under its patent rights nor the rights of others. Motorola products are not designed, intended, or authorized for use as components in systems intended for surgical implant into the body, or other applications intended to support or sustain life, or for any other application in which the failure of the Motorola product could create a situation where personal injury or death may occur. Should Buyer purchase or use Motorola products for any such unintended or unauthorized application, Buyer shall indemnify and hold Motorola and its officers, employees, subsidiaries, affiliates, and distributors harmless against all claims, costs, damages, and expenses, and reasonable attorney fees arising out of, directly or indirectly, any claim of personal injury or death associated with such unintended or unauthorized use, even if such claim alleges that Motorola was negligent regarding the design or manufacture of the part. Motorola and  are registered trademarks of Motorola, Inc. Motorola, Inc. is an Equal Opportunity/Affirmative Action Employer.

#### How to reach us:

**USA/EUROPE/Locations Not Listed:** Motorola Literature Distribution;  
P.O. Box 20912; Phoenix, Arizona 85036. 1-800-441-2447 or 602-303-5454

**MFAX:** RMFAX0@email.sps.mot.com – TOUCHTONE 602-244-6609  
**INTERNET:** <http://Design-NET.com>

**JAPAN:** Nippon Motorola Ltd.; Tatsumi-SPD-JLDC, 6F Seibu-Butsuryu-Center,  
3-14-2 Tatsumi Koto-Ku, Tokyo 135, Japan. 03-81-3521-8315

**ASIA/PACIFIC:** Motorola Semiconductors H.K. Ltd.; 8B Tai Ping Industrial Park,  
51 Ting Kok Road, Tai Po, N.T., Hong Kong. 852-26629298



LF441C/D

