

2012 Size

900/1100 MHz

Chip Multilayer Splitter/Combiner

FSLH-S100C

All the technical data and information contained herein are subject to change without notice.



LH-FSLH-S100C-0406A

Equivalent Circuits

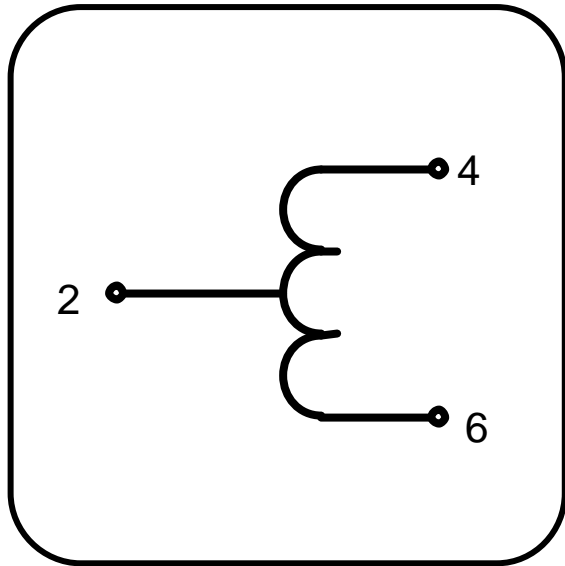

Shape & Size

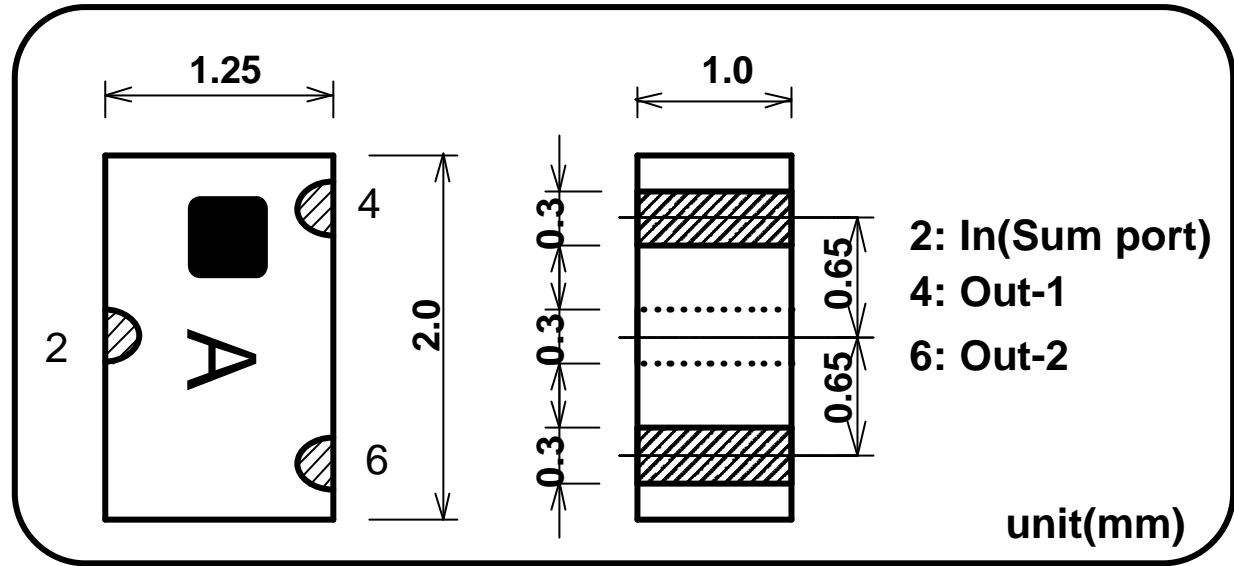

Specifications

Part Name: FSLH-S100C

Frequency Range	Matching Capacitor	Insertion Loss *1	Isolation	Return Loss	Handling Power	Temperature Range
900-1100MHz	2.0pF	1dB Max. (0.25dB Typ.)	12dB Min. (23dB Typ.)	10dB Min. (17dB Typ.)	1W Max. (CW)	-35 to +85 deg.C

*1 Not include splitting loss (3dB)

All the technical data and information contained herein are subject to change without notice.

LH-FSLH-S100C-0406A

FOOT PATTERN

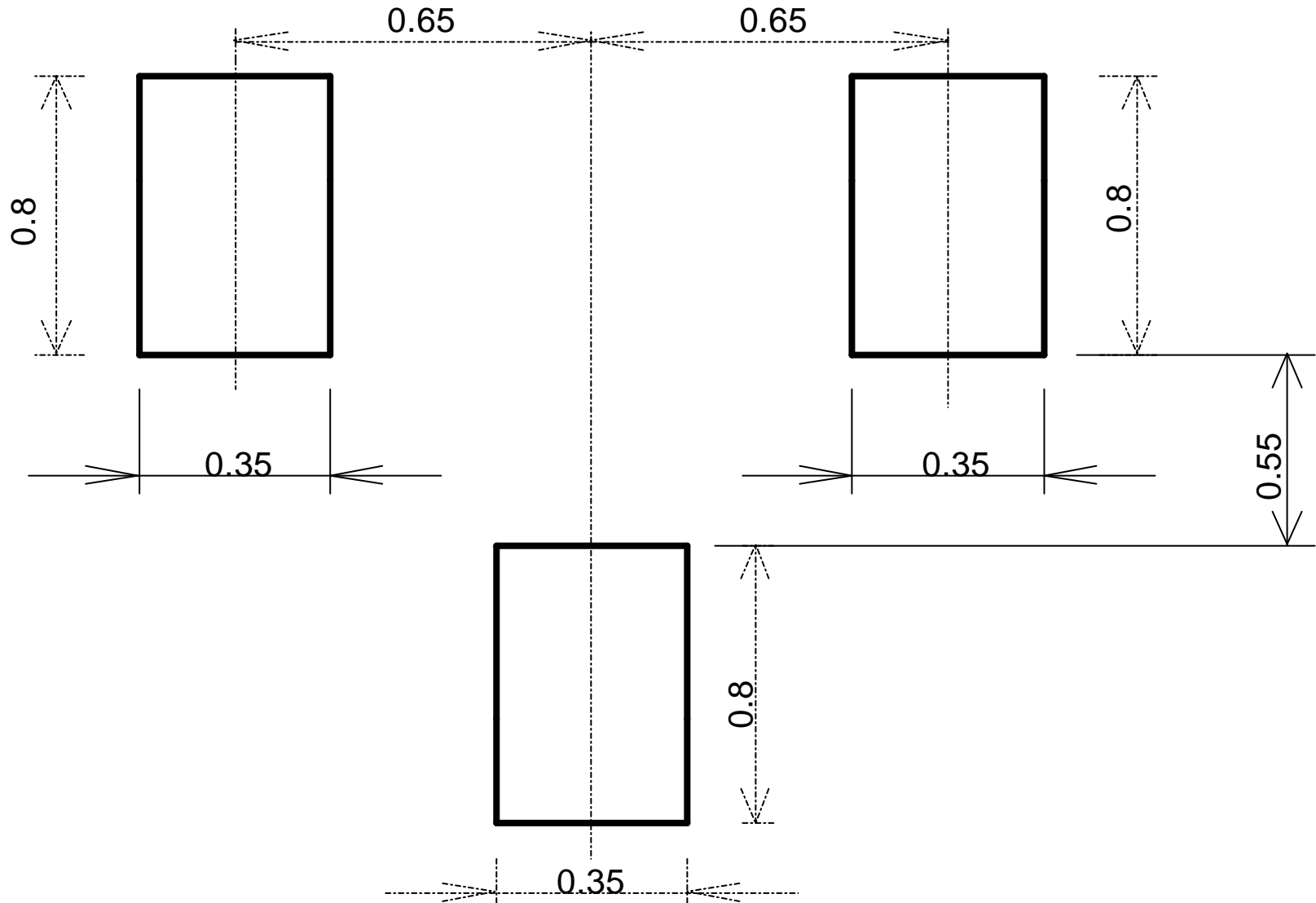

All the technical data and information contained herein are subject to change without notice.

LH-FSLH-S100C-0406A

FSLH-S100C Sample Data

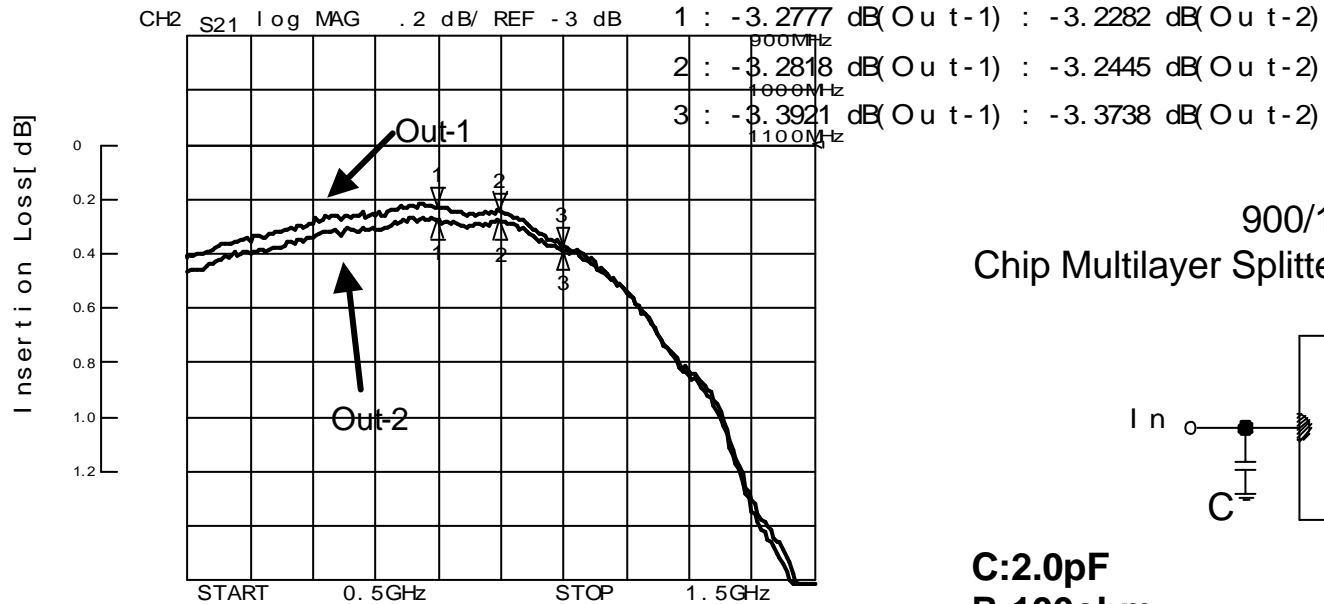
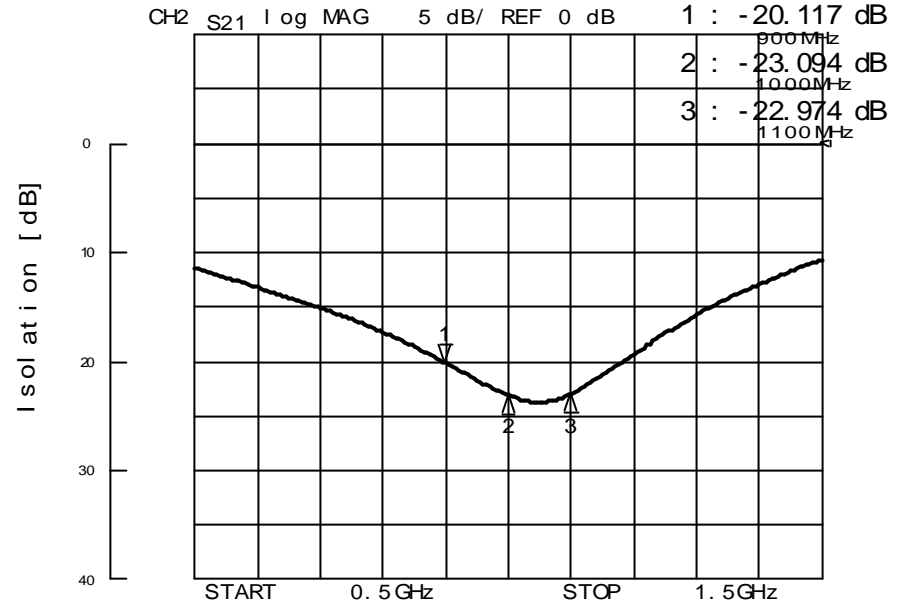
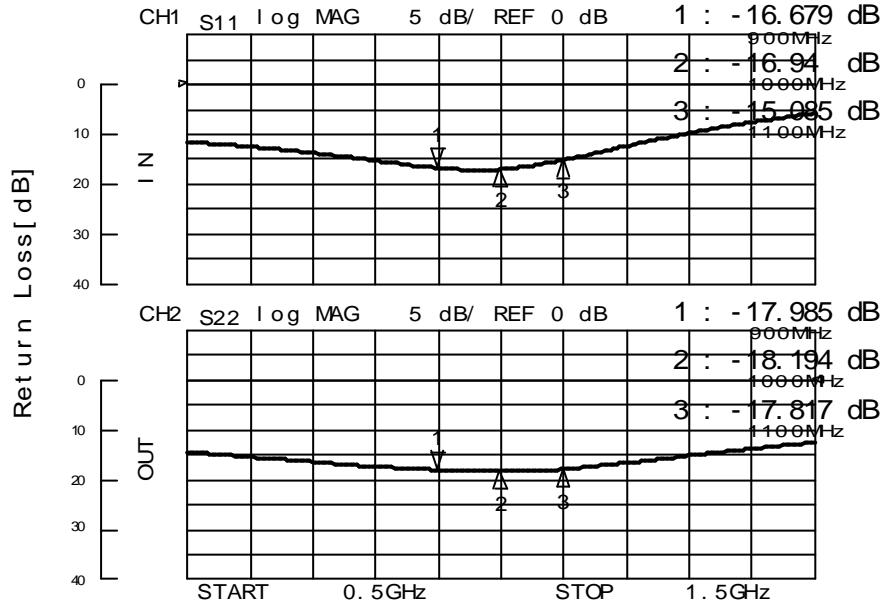

900/1100 MHz
Chip Multilayer Splitter/Combiner "FSLH-S100C"

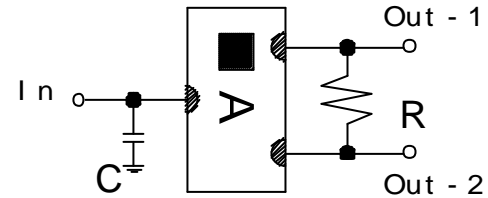

C:2.0pF
R:100ohm

LH-FSLH-S100C-0406A