



LM1040 Dual DC Operated Tone/Volume/Balance Circuit with Stereo Enhancement Facility

General Description

The LM1040 is a DC controlled tone (bass/treble), volume and balance circuit for stereo applications in car radio, TV and audio systems. A stereo enhancement facility is included whereby the apparent stereo separation of systems requiring closely spaced speakers may be improved. An additional control input allows loudness compensation to be simply effected.

Four control inputs provide control of the bass, treble, balance and volume functions through application of DC voltages from a remote control system or, alternatively, from four potentiometers which may be biased from a zener regulated supply provided on the circuit.

Each tone response is defined by a single capacitor chosen to give the desired characteristic.

Features

- Wide supply voltage range, 9V to 16V
- Large volume control range, 75 dB typical
- Tone control, ± 15 dB typical
- Channel separation, 75 dB typical
- Low distortion, 0.06% typical for an input level of 0.3 Vrms
- High signal to noise, 80 dB typical for an input level of 0.3 Vrms
- Few external components required

Block and Connection Diagrams

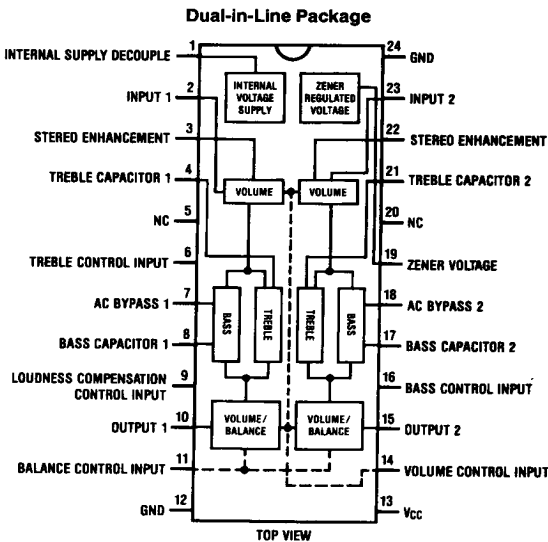

TL/H/5147-1

Order Number LM1040N
See NS Package Number N24A

Absolute Maximum Ratings

If Military/Aerospace specified devices are required, please contact the National Semiconductor Sales Office/Distributors for availability and specifications.

Supply Voltage 16V
Control Pin Voltage (Pins 6, 9, 11, 14, 16) V_{CC}
Operating Temperature Range 0°C to $+70^{\circ}\text{C}$

Storage Temperature Range -65°C to $+150^{\circ}\text{C}$
Power Dissipation 1.5W
Lead Temperature (Soldering, 10 sec.) 260°C

Electrical Characteristics $V_{CC} = 12\text{V}$, $T_A = 25^{\circ}\text{C}$ (unless otherwise stated)

Parameter	Conditions	Min	Typ	Max	Units
Supply Voltage Range	Pin 13	9		16	V
Supply Current			35	45	mA
Zener Regulated Output Voltage	Pin 19		5.4		V
Current				5	mA
Maximum Output Voltage	Pins 10, 15; $f = 1\text{ kHz}$ $V_{CC} = 9\text{V}$, Maximum Gain $V_{CC} = 12\text{V}$	0.8	0.8 1.0		Vrms Vrms
Maximum Input Voltage (Note 1)	Pins 2, 23; $f = 1\text{ kHz}$, $V_{CC} = 9\text{V}$ Flat Response, $V_{CC} = 12\text{V}$ Gain = -10 dB	1.3	1.1 1.6		Vrms Vrms
Input Resistance	Pins 2, 23; $f = 1\text{ kHz}$	20	30		$k\Omega$
Output Resistance	Pins 10, 15; $f = 1\text{ kHz}$		20		Ω
Maximum Gain	$V(\text{Pin } 14) = V(\text{Pin } 19)$; $f = 1\text{ kHz}$	-2	0	2	dB
Volume Control Range	$f = 1\text{ kHz}$	70	75		dB
Gain Tracking Channel 1-Channel 2	$f = 1\text{ kHz}$ 0 dB through -40 dB -40 dB through -60 dB		1 2	3	dB dB
Balance Control Range	Pins 10, 15; $f = 1\text{ kHz}$		1 -26	-20	dB dB
Bass Control Range (Note 2)	$f = 40\text{ Hz}$, $C_b = 0.39\ \mu\text{F}$ $V(\text{Pin } 16) = V(\text{Pin } 19)$ $V(\text{Pin } 16) = 0\text{V}$	12 -12	15 -15	18 -18	dB dB
Treble Control Range (Note 2)	$f = 16\text{ kHz}$, $C_t = 0.01\ \mu\text{F}$ $V(\text{Pin } 6) = V(\text{Pin } 19)$ $V(\text{Pin } 6) = 0\text{V}$	12 -12	15 -15	18 -18	dB dB
Total Harmonic Distortion	$f = 1\text{ kHz}$, $V_{IN} = 0.3\text{ Vrms}$ Gain = 0 dB Gain = -30 dB		0.06 0.03	0.3	% %
Channel Separation	$f = 1\text{ kHz}$, Maximum Gain	60	75		dB
Signal/Noise Ratio	Unweighted 100 Hz-20 kHz Maximum Gain, 0 dB = 0.3 Vrms CCIR/ARM (Note 3) Gain = 0 dB, $V_{IN} = 0.3\text{ Vrms}$ Gain = -20 dB , $V_{IN} = 1.0\text{ Vrms}$	75	79 72		dB dB
Output Noise Voltage at Minimum Gain	CCIR/ARM (Note 3)		10		μV
Supply Ripple Rejection	200 mVrms, 1 kHz Ripple	35	-50		dB
Control Input Currents	Pins 6, 9, 11, 14, 16 ($V = 0\text{V}$)		-0.6	-2.5	μA
Frequency Response	-1 dB (Flat Response) 20 Hz – 16 kHz		250		kHz

Note 1: The maximum permissible input level is dependent on tone and volume settings. See Application Notes.

Note 2: The tone control range is defined by capacitors C_b and C_t . See Application Notes.

Note 3: Gaussian noise, measured over a period of 50 ms per channel, with a CCIR filter referenced to 2 kHz and an average-responding meter.

Typical Performance Characteristics

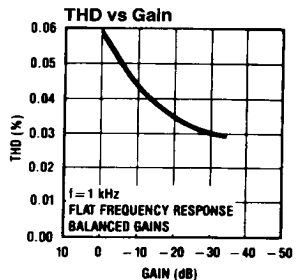
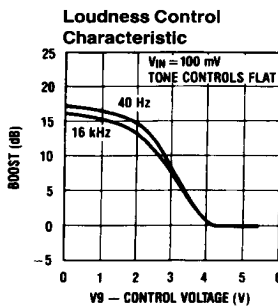
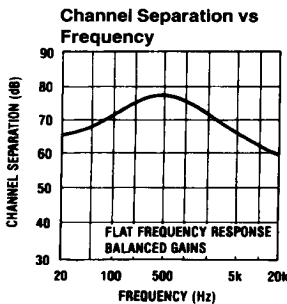
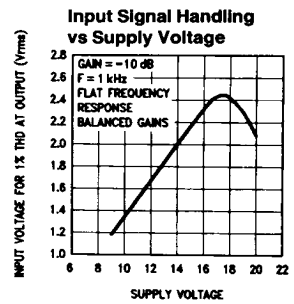
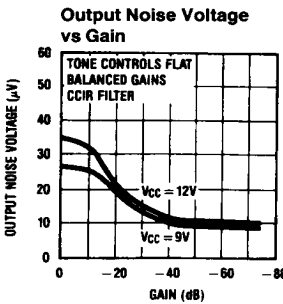
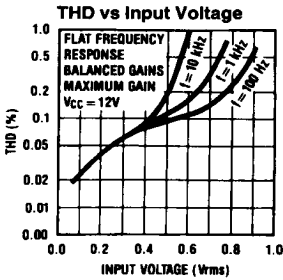
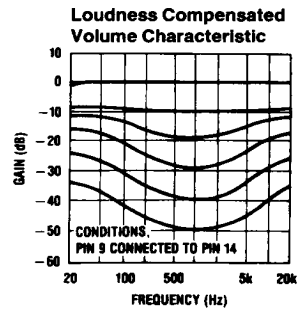
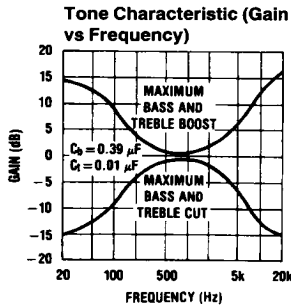
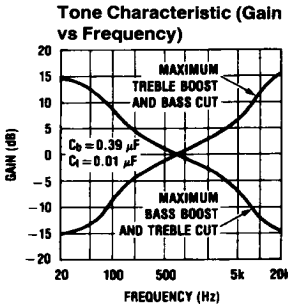
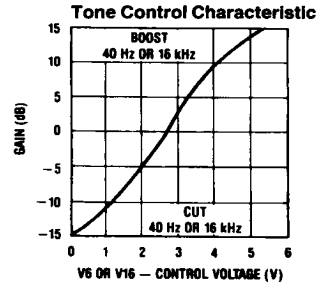
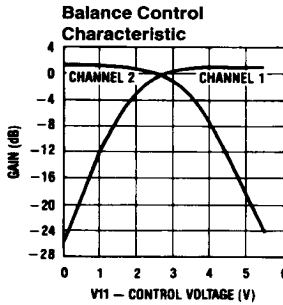
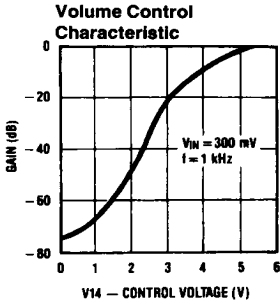

TL/H/5147-2

Application Notes

TONE RESPONSE

The maximum boost and cut can be optimized for individual applications by selection of the appropriate values of C_t (treble) and C_b (bass).

The tone responses are defined by the relationships:

$$\text{Bass Response} = \frac{1 + \frac{0.00065(1 - a_b)}{j\omega C_b}}{1 + \frac{0.00065a_b}{j\omega C_b}}$$

$$\text{Treble Response} = \frac{1 + j\omega 5500(1 - a_t)C_t}{1 + j\omega 5500a_t C_t}$$

Where $a_b = a_t = 0$ for maximum bass and treble boost respectively and $a_b = a_t = 1$ for maximum cut.

For the values of C_b and C_t of $0.39 \mu\text{F}$ and $0.01 \mu\text{F}$ as shown in the Application Circuit, 15 dB of boost or cut is obtained at 40 Hz and 16 kHz.

STEREO ENHANCEMENT

When stereo system speakers need to be closer than optimum because of equipment/cabinet limitations, an improved stereo effect can be obtained using a modest amount of phase-reversed interchannel cross-coupling. In the LM1040 the input stage transistor emitters are brought

out to facilitate this. The arrangement is shown below in basic form.

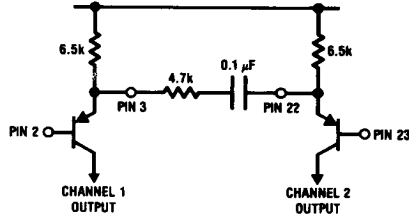

TL/H/5147-3

With a monophonic source, the emitters have the same signal and the resistor and capacitor connected between them have no effect. With a stereo signal each transistor works in the grounded base mode for stereo components, generating an in-phase signal from the opposite channel. As the normal signals are inverted at this point, the appropriate phase-reversed cross-coupling is achieved. An effective level of coupling of 60% can be obtained using 4.7k in conjunction with the internal 6.5k emitter resistors. At low frequencies, speakers become less directional and it becomes desirable to reduce the enhancement effect. With a $0.1 \mu\text{F}$ coupling capacitor, as shown, roll-off occurs below 330 Hz. The coupling components may be varied for alternative responses.

Application Circuit

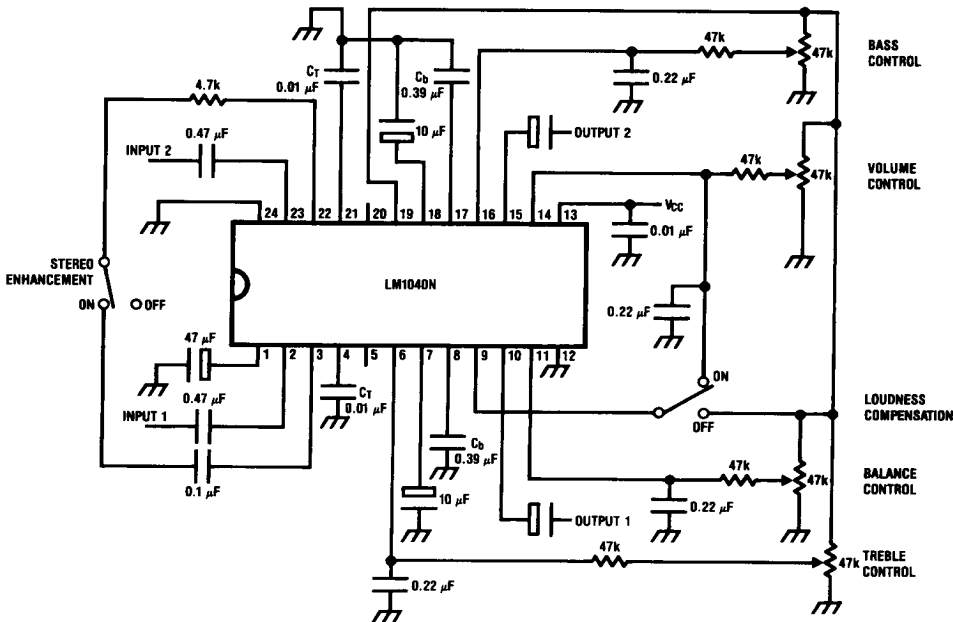

TL/H/5147-4

1

Application Notes (Continued)

ZENER VOLTAGE

A zener voltage (pin 19 = 5.4V) is provided which may be used to bias the control potentiometers. Setting a DC level of one half of the zener voltage on the control inputs, pins 6, 11, and 16, results in the balanced gain and flat response condition. Typical spread on the zener voltage is ± 100 mV and this must be taken into account if control signals are used which are not referenced to the zener voltage. If this is the case, then they will need to be derived with similar accuracy.

LOUDNESS COMPENSATION

A simple loudness compensation may be effected by applying a DC control voltage to pin 9. This operates on the tone control stages to produce an additional boost limited by the maximum boost defined by C_b and C_t . There is no loudness compensation when pin 9 is connected to pin 19. Pin 9 can be connected to pin 14 to give the loudness compensated volume characteristic as illustrated without the addition of further external components. (Tone settings are for flat response, C_b and C_t as given in Application Circuit.) Modification to the loudness characteristic is possible by changing the capacitors C_b and C_t for a different basic response or, by a resistor network between pins 9 and 14 for a different threshold and slope.

SIGNAL HANDLING

The volume control function of the LM1040 is carried out in two stages, controlled by the DC voltage on pin 14, to improve signal handling capability and provide a reduction of output noise level at reduced gain. The first stage is before the tone control processing and provides an initial 15 dB of gain reduction, so ensuring that the tone sections are not overdriven by large input levels when operating with a low volume setting. Any combination of tone and volume settings may be used provided the output level does not exceed 1 Vrms, $V_{CC} = 12V(0.7 \text{ Vrms}, V_{CC} = 9V)$. At reduced gain (< -6 dB) the input stage will overload if the input level exceeds 1.6 Vrms, $V_{CC} = 12V$ (1.1 Vrms, $V_{CC} = 9V$). As there is volume control on the input stages, the inputs may be operated with a lower overload margin than would otherwise be acceptable, allowing a possible improvement in signal to noise ratio.

Applications Information

OBTAINING MODIFIED RESPONSE CURVES

The LM1040 is a dual DC controlled bass, treble, balance and volume integrated circuit ideal for stereo audio systems. In the various applications where the LM1040 can be used, there may be requirements for responses different to those of the standard application circuit given in the data sheet. This application section details some of the simple variations possible on the standard responses, to assist the choice of optimum characteristics for particular applications.

tone Controls

Summarizing the relationship given in the data sheet, basically for an increase in the treble control range C_t must be increased, and for increased bass range C_b must be reduced.

Figure 1 shows the typical tone response obtained in the standard application circuit. ($C_t = 0.01 \mu\text{F}$, $C_b = 0.39 \mu\text{F}$). Response curves are given for various amounts of boost and cut.

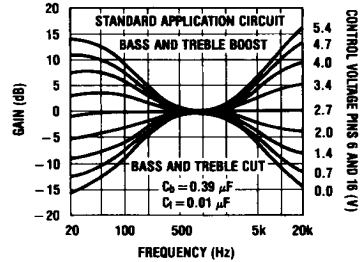

TL/H/5147-5

FIGURE 1. Tone Characteristic (Gain vs Frequency)

Figures 2 and 3 show the effect of changing the response defining capacitors C_t and C_b to $2C_t$, $C_b/2$ and $4C_t$, $C_b/4$ respectively, giving increased tone control ranges. The values of the bypass capacitors may become significant and affect the lower frequencies in the bass response curves.

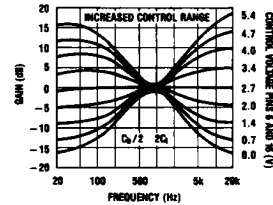

TL/H/5147-6

FIGURE 2: Tone Characteristic (Gain vs Frequency)

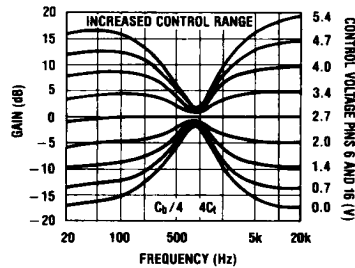

TL/H/5147-7

FIGURE 3: Tone Characteristic (Gain vs Frequency)

Applications Information (Continued)

Figure 4 shows the effect of changing C_t and C_b in the opposite direction to $C_t/2$, $2C_b$ respectively giving reduced control ranges. The various results corresponding to the different C_t and C_b values may be mixed if it is required to give a particular emphasis to, for example, the bass control. The particular case with $C_b/2$, C_t is illustrated in Figure 5.

RESTRICTION OF TONE CONTROL ACTION AT HIGH OR LOW FREQUENCIES

It may be desired in some applications to level off the tone responses above or below certain frequencies for example to reduce high frequency noise.

This may be achieved for the treble response by including a resistor in series with C_t . The treble boost and cut will be 3 dB less than the standard circuit when $R = X_C$.

A similar effect may be obtained for the bass response by reducing the value of the AC bypass capacitors on pins 7 (channel 1) and 18 (channel 2). The internal resistance at these pins is 1.3 k Ω and the bass boost/cut will be approximately 3 dB less with X_C at this value. An example of such modified response curves is shown in Figure 6. The input coupling capacitors may also modify the low frequency response.

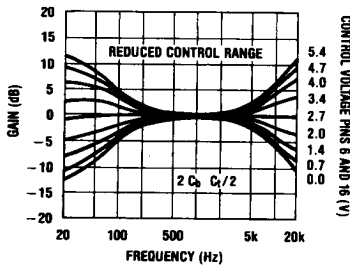

TL/H/5147-8

FIGURE 4. Tone Characteristic (Gain vs Frequency)

It will be seen from Figures 2 and 3 that modifying C_t and C_b for greater control range also has the effect of flattening the tone control extremes and this may be utilized, with or without additional modification as outlined above, for the most suitable tone control range and response shape.

OTHER ADVANTAGES OF DC CONTROLS

The DC controls make the addition of other features easy to arrange. For example, the negative-going peaks of the output amplifiers may be detected below a certain level, and used to bias back the bass control from a high boost condition; to prevent overloading the speaker with low frequency components.

LOUDNESS CONTROL

The loudness control is achieved through control of the tone sections by the voltage applied to pin 9; therefore, the tone and loudness functions are not independent. There is normally 1 dB more bass than treble boost (40 Hz - 16 kHz) with loudness control in the standard circuit. If a greater difference is desired, it is necessary to introduce an offset by means of C_t or C_b or by changing the nominal control voltage ranges.

Figure 7 shows the typical loudness curves obtained in the standard application circuit at various volume levels ($C_b = 0.39 \mu\text{F}$).

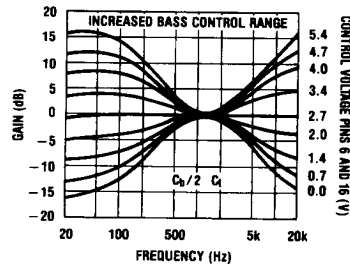

TL/H/5147-9

FIGURE 5. Tone Characteristic (Gain vs Frequency)

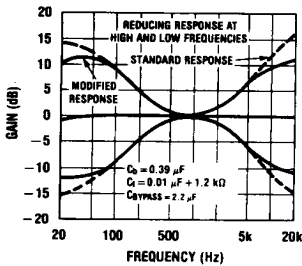

TL/H/5147-10

FIGURE 6. Tone Characteristic (Gain vs Frequency)

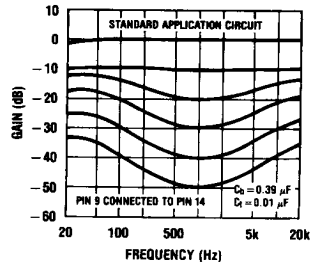

TL/H/5147-11

FIGURE 7. Loudness Compensated Volume Characteristic

Applications Information (Continued)

Figures 8 and 9 illustrate the loudness characteristics obtained with C_b changed to $C_b/2$ and $C_b/4$ respectively, C_t being kept at the nominal $0.01 \mu\text{F}$. These values naturally modify the bass tone response as in Figures 2 and 3.

With pins 9 (loudness) and 14 (volume) directly connected, loudness control starts at typically -8 dB volume, with most of the control action complete by -30 dB .

Figures 10 and 11 show the effect of resistively offsetting the voltage applied to pin 9 towards the control reference

voltage (pin 19). Because the control inputs are high impedance, this is easily done and high value resistors may be used for minimal additional loading. It is possible to reduce the rate of onset of control to extend the active range to -50 dB volume control and below.

The control on pin 9 may also be divided down towards ground bringing the control action on earlier. This is illustrated in Figure 12. With a suitable level shifting network between pins 14 and 9, the onset of loudness control and its rate of change may be readily modified.

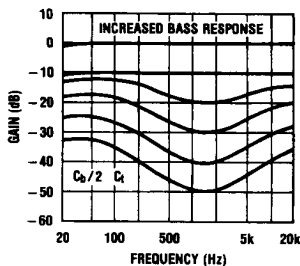

FIGURE 8. Loudness Compensated Volume Characteristic

TL/H/5147-12

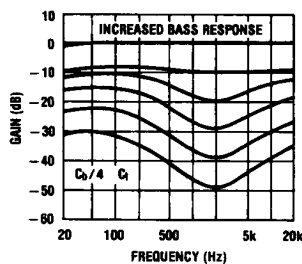

FIGURE 9. Loudness Compensated Volume Characteristic

TL/H/5147-13

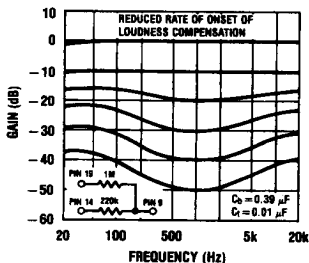

FIGURE 10. Loudness Compensated Volume Characteristic

TL/H/5147-14

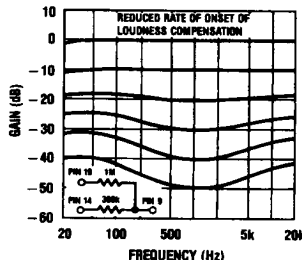

FIGURE 11. Loudness Compensated Volume Characteristic

TL/H/5147-15

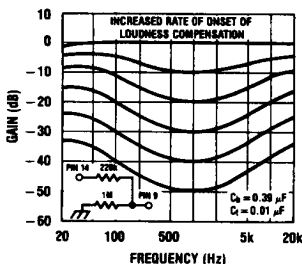

FIGURE 12. Loudness Compensated Volume Characteristic

TL/H/5147-16

Applications Information (Continued)

When adjusted for maximum boost in the usual application circuit, the LM-1040 cannot give additional boost from the loudness control with reducing gain. If it is required, some additional boost can be obtained by restricting the tone control range and modifying C_t , C_b , to compensate. A circuit illustrating this for the case of bass boost is shown in *Figure 13*. The resulting responses are given in *Figure 14* showing the continuing loudness control action possible with bass boost previously applied.

USE OF THE LM1040 ABOVE AUDIO FREQUENCIES

The LM1040 has a basic response typically 1 dB down at 250 kHz (tone controls flat) and therefore by scaling C_b and C_t it is possible to arrange for operation over a wide frequency range for possible use in wide band equalization applications. As an example *Figure 15* shows the responses obtained centered on 10 kHz with $C_b = 0.039 \mu\text{F}$ and $C_t = 0.001 \mu\text{F}$.

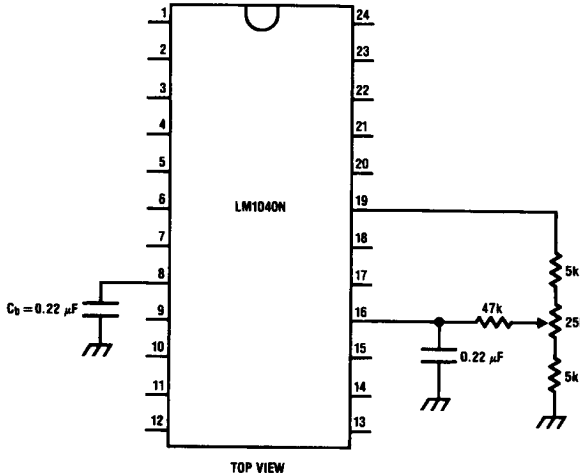

FIGURE 13. Modified Application Circuit for Additional Bass Boost with Loudness Control

TL/H/5147-17

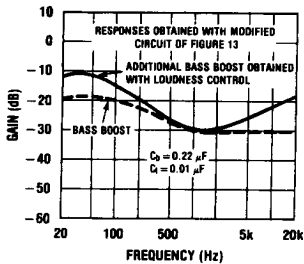

FIGURE 14. Loudness Compensated Volume Characteristic

TL/H/5147-18

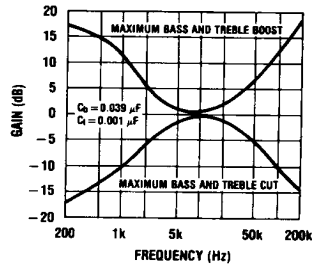

FIGURE 15. Tone Characteristic (Gain vs Frequency)

TL/H/5147-19



Simplified Schematic Diagram (One Channel)

LM1040

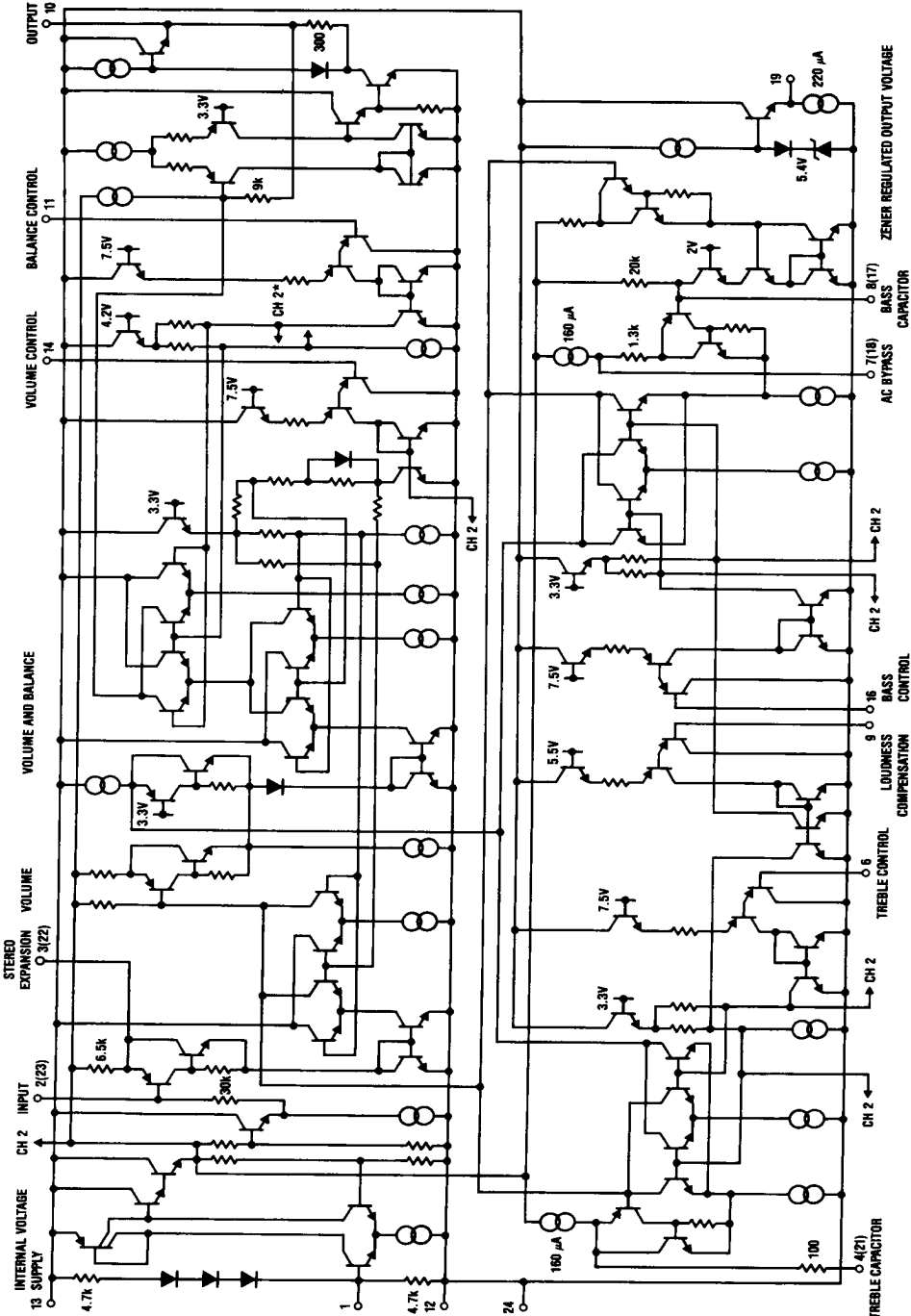

*Connections reversed

TL/H/5147-21