

LM140/LM340A/LM340/LM7800C Series 3-Terminal Positive Regulators

General Description

The LM140/LM340A/LM340/LM7800C monolithic 3-terminal positive voltage regulators employ internal current-limiting, thermal shutdown and safe-area compensation, making them essentially indestructible. If adequate heat sinking is provided, they can deliver over 1.0A output current. They are intended as fixed voltage regulators in a wide range of applications including local (on-card) regulation for elimination of noise and distribution problems associated with single-point regulation. In addition to use as fixed voltage regulators, these devices can be used with external components to obtain adjustable output voltages and currents.

Considerable effort was expended to make the entire series of regulators easy to use and minimize the number of external components. It is not necessary to bypass the output, although this does improve transient response. Input bypassing is needed only if the regulator is located far from the filter capacitor of the power supply.

The 5V, 12V, and 15V regulator options are available in the steel TO-3 power package. The LM340A/LM340/LM7800C series is available in the TO-220 plastic power package, and the LM340-5.0 is available in the SOT-223 package, as well as the LM340-5.0 and LM340-12 in the surface-mount TO-263 package.

Features

- Complete specifications at 1A load
- Output voltage tolerances of $\pm 2\%$ at $T_j = 25^\circ\text{C}$ and $\pm 4\%$ over the temperature range (LM140A/LM340A)
- Line regulation of 0.01% of V_{OUT}/V of ΔV_{IN} at 1A load (LM140A/LM340A)
- Load regulation of 0.3% of V_{OUT}/A (LM140A/LM340A)
- Internal thermal overload protection
- Internal short-circuit current limit
- Output transistor safe area protection
- P+ Product Enhancement tested

Device	Output Voltages	Packages
LM140	5, 12, 15	TO-3 (K)
LM340A/LM340	5, 12, 15	TO-3 (K), TO-220 (T), SOT-223 (MP), TO-263 (S) (5V and 12V only)
LM7800C	5, 8, 12, 15	TO-220 (T)

Typical Applications

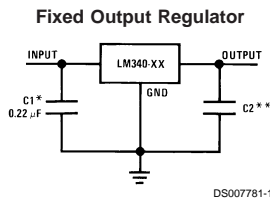

*Required if the regulator is located far from the power supply filter.

**Although no output capacitor is needed for stability, it does help transient response. (If needed, use 0.1 µF, ceramic disc).

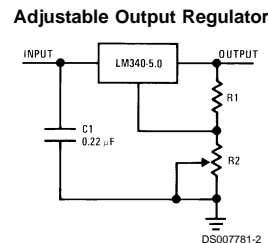

$$V_{OUT} = 5V + (5V/R1 + I_Q) R2 \quad 5V/R1 > 3 I_Q$$

load regulation (L_r) = $\{(R1 + R2)/R1\}$ (L_r of LM340-5).

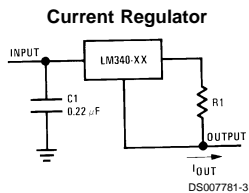

$$I_{OUT} = \frac{V_{2-3}}{R1} + I_Q$$

$$\Delta I_Q = 1.3 \text{ mA over line and load changes.}$$

Comparison between SOT-223 and D-Pak (TO-252) Packages

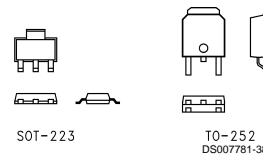

Scale 1:1

Absolute Maximum Ratings (Note 1)

If Military/Aerospace specified devices are required, please contact the National Semiconductor Sales Office/Distributors for availability and specifications.

(Note 5)

DC Input Voltage

All Devices except LM7824/LM7824C 35V
LM7824/LM7824C 40V

Internal Power Dissipation (Note 2) Internally Limited

Maximum Junction Temperature 150°C

Storage Temperature Range -65°C to +150°C

Lead Temperature (Soldering, 10 sec.)

TO-3 Package (K) 300°C

TO-220 Package (T), TO-263 Package (S) 230°C

ESD Susceptibility (Note 3) 2 kV

Operating Conditions (Note 1)

Temperature Range (T_A) (Note 2)

LM140A, LM140 -55°C to +125°C

LM340A, LM340, LM7805C, LM7812C, LM7815C, LM7808C 0°C to +125°C

LM340A Electrical Characteristics

I_{OUT} = 1A, -55°C ≤ T_J ≤ +150°C (LM140A), or 0°C ≤ T_J ≤ +125°C (LM340A) unless otherwise specified (Note 4)

Symbol	Output Voltage		5V			12V			15V			Units
	Input Voltage (unless otherwise noted)		10V			19V			23V			
	Parameter	Conditions	Min	Typ	Max	Min	Typ	Max	Min	Typ	Max	
V _O	Output Voltage	T _J = 25°C	4.9	5	5.1	11.75	12	12.25	14.7	15	15.3	V
		P _D ≤ 15W, 5 mA ≤ I _O ≤ 1A	4.8		5.2	11.5		12.5	14.4		15.6	V
		V _{MIN} ≤ V _{IN} ≤ V _{MAX}	(7.5 ≤ V _{IN} ≤ 20)			(14.8 ≤ V _{IN} ≤ 27)			(17.9 ≤ V _{IN} ≤ 30)			V
ΔV _O	Line Regulation	I _O = 500 mA			10			18			22	mV
		ΔV _{IN}	(7.5 ≤ V _{IN} ≤ 20)			(14.8 ≤ V _{IN} ≤ 27)			(17.9 ≤ V _{IN} ≤ 30)			V
		T _J = 25°C		3	10		4	18		4	22	mV
		ΔV _{IN}	(7.5 ≤ V _{IN} ≤ 20)			(14.5 ≤ V _{IN} ≤ 27)			(17.5 ≤ V _{IN} ≤ 30)			V
		T _J = 25°C Over Temperature			4		9		10		30	mV
ΔV _O	Load Regulation	T _J = 25°C	5 mA ≤ I _O ≤ 1.5A	10	25	12	32	12	35			mV
			250 mA ≤ I _O ≤ 750 mA		15		19		21			mV
		Over Temperature, 5 mA ≤ I _O ≤ 1A			25		60		75			mV
I _O	Quiescent Current	T _J = 25°C			6		6		6		6	mA
		Over Temperature			6.5		6.5		6.5		6.5	mA
ΔI _O	Quiescent Current Change	5 mA ≤ I _O ≤ 1A			0.5		0.5		0.5		0.5	mA
		T _J = 25°C, I _O = 1A			0.8		0.8		0.8		0.8	mA
		V _{MIN} ≤ V _{IN} ≤ V _{MAX}	(7.5 ≤ V _{IN} ≤ 20)			(14.8 ≤ V _{IN} ≤ 27)			(17.9 ≤ V _{IN} ≤ 30)			V
		I _O = 500 mA V _{MIN} ≤ V _{IN} ≤ V _{MAX}	(8 ≤ V _{IN} ≤ 25)			(15 ≤ V _{IN} ≤ 30)			(17.9 ≤ V _{IN} ≤ 30)			V
V _N	Output Noise Voltage	T _A = 25°C, 10 Hz ≤ f ≤ 100 kHz			40		75			90	μV	
$\frac{\Delta V_{IN}}{\Delta V_{OUT}}$	Ripple Rejection	T _J = 25°C, f = 120 Hz, I _O = 1A or f = 120 Hz, I _O = 500 mA, Over Temperature, V _{MIN} ≤ V _{IN} ≤ V _{MAX}	68	80		61	72		60	70		dB
			68			61			60			dB
R _O	Dropout Voltage Output Resistance Short-Circuit Current Peak Output Current Average TC of V _O	T _J = 25°C, I _O = 1A			2.0		2.0		2.0			V
		f = 1 kHz			8		18		19			mΩ
		T _J = 25°C			2.1		1.5		1.2			A
		T _J = 25°C			2.4		2.4		2.4			A
		Min, T _J = 0°C, I _O = 5 mA			-0.6		-1.5		-1.8			mV/°C
V _{IN}	Input Voltage Required to Maintain Line Regulation	T _J = 25°C			7.5		14.5			17.5	V	

LM140 Electrical Characteristics (Note 4)

-55°C ≤ T_J ≤ +150°C unless otherwise specified

Symbol	Output Voltage		5V			12V			15V			Units	
	Input Voltage (unless otherwise noted)		10V			19V			23V				
	Parameter	Conditions	Min	Typ	Max	Min	Typ	Max	Min	Typ	Max		
V _O	Output Voltage	T _J = 25°C, 5 mA ≤ I _O ≤ 1A	4.8	5	5.2	11.5	12	12.5	14.4	15	15.6	V	
		P _D ≤ 15W, 5 mA ≤ I _O ≤ 1A	4.75		5.25	11.4		12.6	14.25		15.75	V	
		V _{MIN} ≤ V _{IN} ≤ V _{MAX}			(8 ≤ V _{IN} ≤ 20)			(15.5 ≤ V _{IN} ≤ 27)			(18.5 ≤ V _{IN} ≤ 30)	V	
ΔV _O	Line Regulation	I _O = 500 mA	T _J = 25°C	3	50		4	120		4	150	mV	
			ΔV _{IN}		(7 ≤ V _{IN} ≤ 25)		(14.6 ≤ V _{IN} ≤ 30)		(17.5 ≤ V _{IN} ≤ 30)			mV	
			-55°C ≤ T _J ≤ +150°C		50		120		150			mV	
		I _O ≤ 1A	ΔV _{IN}		(8 ≤ V _{IN} ≤ 20)		(15 ≤ V _{IN} ≤ 27)		(18.5 ≤ V _{IN} ≤ 30)			mV	
			T _J = 25°C		50		120		150			mV	
			ΔV _{IN}		(7.5 ≤ V _{IN} ≤ 20)		(14.6 ≤ V _{IN} ≤ 27)		(17.7 ≤ V _{IN} ≤ 30)			V	
ΔV _O	Load Regulation	T _J = 25°C	5 mA ≤ I _O ≤ 1.5A	10	50		12	120		12	150	mV	
			250 mA ≤ I _p ≤ 750 mA		25		60		75			mV	
		-55°C ≤ T _J ≤ +150°C,	5 mA ≤ I _O ≤ 1A	ΔV _{IN}		(8 ≤ V _{IN} ≤ 12)		(16 ≤ V _{IN} ≤ 22)		(20 ≤ V _{IN} ≤ 26)			V
						50		120		150			mV
I _Q	Quiescent Current	I _O ≤ 1A	T _J = 25°C		6		6			6	mA		
			-55°C ≤ T _J ≤ +150°C		7		7		7			mA	
ΔI _Q	Quiescent Current Change	5 mA ≤ I _O ≤ 1A			0.5		0.5		0.5		mA		
		T _J = 25°C, I _O ≤ 1A			0.8		0.8		0.8		mA		
		V _{MIN} ≤ V _{IN} ≤ V _{MAX}			(8 ≤ V _{IN} ≤ 20)		(15 ≤ V _{IN} ≤ 27)		(18.5 ≤ V _{IN} ≤ 30)			V	
		I _O = 500 mA, -55°C ≤ T _J ≤ +150°C			0.8		0.8		0.8			mA	
V _N	Output Noise Voltage	T _A = 25°C, 10 Hz ≤ f ≤ 100 kHz			40		75		90		μV		
		f = 120 Hz	I _O ≤ 1A, T _J = 25°C or	68	80		61	72		60	70	dB	
			I _O ≤ 500 mA,	68			61		60			dB	
		-55°C ≤ T _J ≤ +150°C			(8 ≤ V _{IN} ≤ 25)		(15 ≤ V _{IN} ≤ 30)		(18.5 ≤ V _{IN} ≤ 30)		V		
R _O	Dropout Voltage	T _J = 25°C, I _O = 1A		2.0		2.0		2.0			V		
	Output Resistance	f = 1 kHz		8		18		19			mΩ		
	Short-Circuit Current	T _J = 25°C		2.1		1.5		1.2			A		
	Peak Output Current	T _J = 25°C		2.4		2.4		2.4			A		
	Average TC of V _{OUT}	0°C ≤ T _J ≤ +150°C, I _O = 5 mA		-0.6		-1.5		-1.8			mV/°C		
V _{IN}	Input Voltage Required to Maintain Line Regulation	T _J = 25°C, I _O ≤ 1A		7.5		14.6		17.7			V		

LM340/LM7800C Electrical Characteristics (Note 4)

0°C ≤ T_J ≤ +125°C unless otherwise specified

Symbol	Output Voltage		5V			12V			15V			Units	
	Input Voltage (unless otherwise noted)		10V			19V			23V				
	Parameter	Conditions	Min	Typ	Max	Min	Typ	Max	Min	Typ	Max		
V _O	Output Voltage	T _J = 25°C, 5 mA ≤ I _O ≤ 1A	4.8	5	5.2	11.5	12	12.5	14.4	15	15.6	V	
		P _D ≤ 15W, 5 mA ≤ I _O ≤ 1A	4.75		5.25	11.4		12.6	14.25		15.75	V	
		V _{MIN} ≤ V _{IN} ≤ V _{MAX}	(7.5 ≤ V _{IN} ≤ 20)			(14.5 ≤ V _{IN} ≤ 27)			(17.5 ≤ V _{IN} ≤ 30)			V	
ΔV _O	Line Regulation	I _O = 500 mA	T _J = 25°C	3	50	4	120	4	150			mV	
			ΔV _{IN}	(7 ≤ V _{IN} ≤ 25)	(14.5 ≤ V _{IN} ≤ 30)	(17.5 ≤ V _{IN} ≤ 30)						V	
			0°C ≤ T _J ≤ +125°C		50		120		150			mV	
		ΔV _{IN}	(8 ≤ V _{IN} ≤ 20)	(15 ≤ V _{IN} ≤ 27)	(18.5 ≤ V _{IN} ≤ 30)						V		
		I _O ≤ 1A	T _J = 25°C		50		120		150			mV	
			ΔV _{IN}	(7.5 ≤ V _{IN} ≤ 20)	(14.6 ≤ V _{IN} ≤ 27)	(17.7 ≤ V _{IN} ≤ 30)						V	
0°C ≤ T _J ≤ +125°C			25		60		75			mV			
ΔV _O	Load Regulation	T _J = 25°C	5 mA ≤ I _O ≤ 1.5A	10	50	12	120	12	150			mV	
			250 mA ≤ I _O ≤ 750 mA		25		60		75			mV	
		5 mA ≤ I _O ≤ 1A, 0°C ≤ T _J ≤ +125°C		50		120		150			mV		
I _O	Quiescent Current	I _O ≤ 1A	T _J = 25°C	8		8		8			mA		
			0°C ≤ T _J ≤ +125°C		8.5		8.5		8.5			mA	
ΔI _O	Quiescent Current Change	5 mA ≤ I _O ≤ 1A			0.5		0.5		0.5			mA	
		T _J = 25°C, I _O ≤ 1A			1.0		1.0		1.0			mA	
		V _{MIN} ≤ V _{IN} ≤ V _{MAX}			(7.5 ≤ V _{IN} ≤ 20)		(14.8 ≤ V _{IN} ≤ 27)		(17.9 ≤ V _{IN} ≤ 30)			V	
		I _O ≤ 500 mA, 0°C ≤ T _J ≤ +125°C			1.0		1.0		1.0			mA	
V _N	Output Noise Voltage	T _A = 25°C, 10 Hz ≤ f ≤ 100 kHz			40		75		90			μV	
		ΔV _{IN} ΔV _{OUT}			62	80	55	72	54	70			dB
R _O	Dropout Voltage	T _J = 25°C, I _O = 1A			2.0		2.0		2.0			V	
		Output Resistance		f = 1 kHz		8		18		19			mΩ
		Short-Circuit Current		T _J = 25°C		2.1		1.5		1.2			A
		Peak Output Current		T _J = 25°C		2.4		2.4		2.4			A
		Average TC of V _{OUT}		0°C ≤ T _J ≤ +125°C, I _O = 5 mA		-0.6		-1.5		-1.8			mV/°C
V _{IN}	Input Voltage Required to Maintain Line Regulation	T _J = 25°C, I _O ≤ 1A			7.5		14.6		17.7			V	

Note 1: Absolute Maximum Ratings are limits beyond which damage to the device may occur. Operating Conditions are conditions under which the device functions but the specifications might not be guaranteed. For guaranteed specifications and test conditions see the Electrical Characteristics.

Note 2: The maximum allowable power dissipation at any ambient temperature is a function of the maximum junction temperature for operation (T_{JMAX} = 125°C or 150°C), the junction-to-ambient thermal resistance (θ_{JA}), and the ambient temperature (T_A). P_{DMAX} = (T_{JMAX} - T_A)/θ_{JA}. If this dissipation is exceeded, the die temperature will rise above T_{JMAX} and the electrical specifications do not apply. If the die temperature rises above 150°C, the device will go into thermal shutdown. For the TO-3 package (K, KC), the junction-to-ambient thermal resistance (θ_{JA}) is 39°C/W. When using a heatsink, θ_{JA} is the sum of the 4°C/W junction-to-case thermal resistance (θ_{JC}) of the TO-3 package and the case-to-ambient thermal resistance of the heatsink. For the TO-220 package (T), θ_{JA} is 54°C/W and θ_{JC} is 4°C/W. If SOT-223 is used, the junction-to-ambient thermal resistance is 174°C/W and can be reduced by a heatsink (see Applications Hints on heatsinking).

If the TO-263 package is used, the thermal resistance can be reduced by increasing the PC board copper area thermally connected to the package: Using 0.5 square inches of copper area, θ_{JA} is 50°C/W; with 1 square inch of copper area, θ_{JA} is 37°C/W; and with 1.6 or more inches of copper area, θ_{JA} is 32°C/W.

Note 3: ESD rating is based on the human body model, 100 pF discharged through 1.5 kΩ.

Note 4: All characteristics are measured with a 0.22 μF capacitor from input to ground and a 0.1 μF capacitor from output to ground. All characteristics except noise voltage and ripple rejection ratio are measured using pulse techniques (t_w ≤ 10 ms, duty cycle ≤ 5%). Output voltage changes due to changes in internal temperature must be taken into account separately.

Note 5: A military RETS specification is available on request. At the time of printing, the military RETS specifications for the LM140AK-5.0/883, LM140AK-12/883, and LM140AK-15/883 complied with the min and max limits for the respective versions of the LM140A. At the time of printing, the military RETS specifications for the LM140K-5.0/883, LM140K-12/883, and LM140K-15/883 complied with the min and max limits for the respective versions of the LM140. The LM140H/883, LM140K/883, and LM140AK/883 may also be procured as a Standard Military Drawing.

LM7808C Electrical Characteristics

$0^{\circ}\text{C} \leq T_J \leq +150^{\circ}\text{C}$, $V_I = 14\text{V}$, $I_O = 500\text{ mA}$, $C_I = 0.33\text{ }\mu\text{F}$, $C_O = 0.1\text{ }\mu\text{F}$, unless otherwise specified

Symbol	Parameter	Conditions (Note 6)	LM7808C			Units
			Min	Typ	Max	
V_O	Output Voltage	$T_J = 25^{\circ}\text{C}$	7.7	8.0	8.3	V
ΔV_O	Line Regulation	$T_J = 25^{\circ}\text{C}$		6.0	160	mV
			$10.5\text{V} \leq V_I \leq 25\text{V}$		2.0	
ΔV_O	Load Regulation	$T_J = 25^{\circ}\text{C}$		12	160	mV
			$5.0\text{ mA} \leq I_O \leq 1.5\text{A}$		4.0	
V_O	Output Voltage	$11.5\text{V} \leq V_I \leq 23\text{V}$, $5.0\text{ mA} \leq I_O \leq 1.0\text{A}$, $P \leq 15\text{W}$	7.6		8.4	V
I_Q	Quiescent Current	$T_J = 25^{\circ}\text{C}$		4.3	8.0	mA
ΔI_Q	Quiescent	With Line With Load	$11.5\text{V} \leq V_I \leq 25\text{V}$ $5.0\text{ mA} \leq I_O \leq 1.0\text{A}$		1.0	mA
	Current Change				0.5	
V_N	Noise	$T_A = 25^{\circ}\text{C}$, $10\text{ Hz} \leq f \leq 100\text{ kHz}$		52		μV
$\Delta V_I/\Delta V_O$	Ripple Rejection	$f = 120\text{ Hz}$, $I_O = 350\text{ mA}$, $T_J = 25^{\circ}\text{C}$	56	72		dB
V_{DO}	Dropout Voltage	$I_O = 1.0\text{A}$, $T_J = 25^{\circ}\text{C}$		2.0		V
R_O	Output Resistance	$f = 1.0\text{ kHz}$		16		$\text{m}\Omega$
I_{OS}	Output Short Circuit Current	$T_J = 25^{\circ}\text{C}$, $V_I = 35\text{V}$		0.45		A
I_{PK}	Peak Output Current	$T_J = 25^{\circ}\text{C}$		2.2		A
$\Delta V_O/\Delta T$	Average Temperature Coefficient of Output Voltage	$I_O = 5.0\text{ mA}$		0.8		$\text{mV}/^{\circ}\text{C}$

Note 6: All characteristics are measured with a $0.22\text{ }\mu\text{F}$ capacitor from input to ground and a $0.1\text{ }\mu\text{F}$ capacitor from output to ground. All characteristics except noise voltage and ripple rejection ratio are measured using pulse techniques ($t_w \leq 10\text{ ms}$, duty cycle $\leq 5\%$). Output voltage changes due to changes in internal temperature must be taken into account separately.

Typical Performance Characteristics

Maximum Average Power
Dissipation

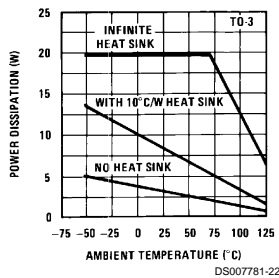

Maximum Average Power
Dissipation

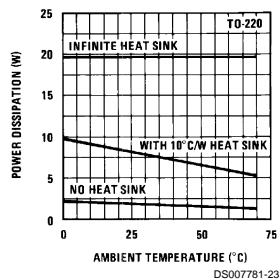

Maximum Power
Dissipation (TO-263)
(See Note 2)

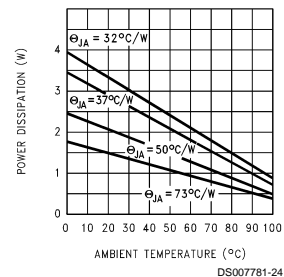

Typical Performance Characteristics (Continued)

Output Voltage (Normalized to 1V at $T_j = 25^\circ\text{C}$)

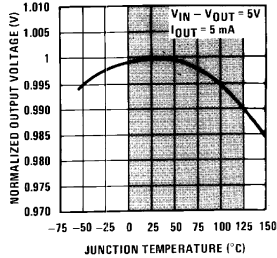

DS007781-25

Note: Shaded area refers to LM340A/LM340, LM7805C, LM7812C and LM7815C.

Ripple Rejection

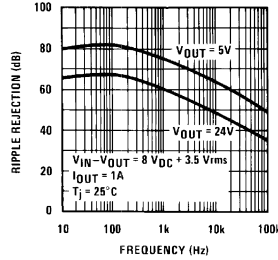

DS007781-26

Ripple Rejection

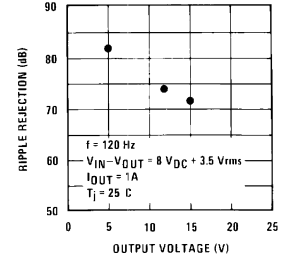

DS007781-27

Output Impedance

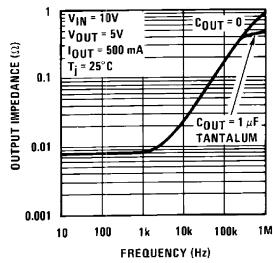

DS007781-28

Dropout Characteristics

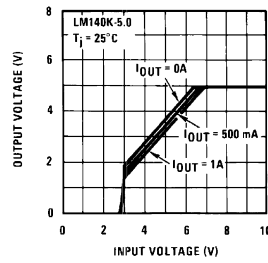

DS007781-29

Quiescent Current

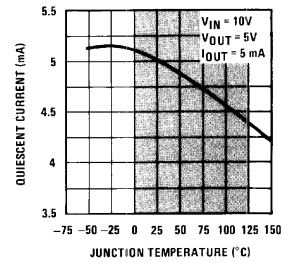

DS007781-30

Note: Shaded area refers to LM340A/LM340, LM7805C, LM7812C and LM7815C.

Peak Output Current

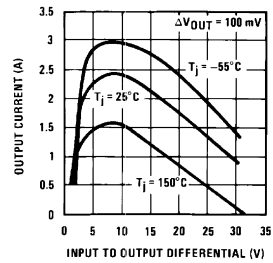

DS007781-31

Dropout Voltage

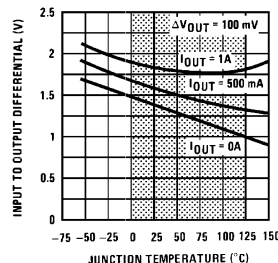

DS007781-32

Note: Shaded area refers to LM340A/LM340, LM7805C, LM7812C and LM7815C.

Quiescent Current

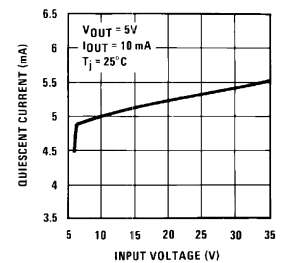

DS007781-33

Typical Performance Characteristics (Continued)

Line Regulation

140AK-5.0, $I_{OUT} = 1A$, $T_A = 25^\circ C$

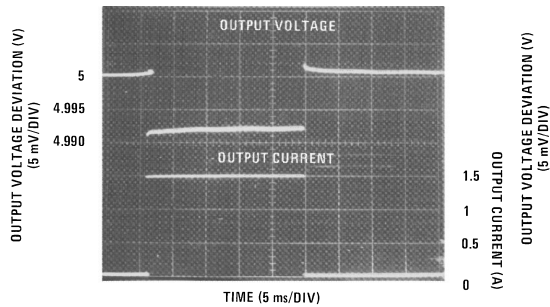

DS007781-5

Line Regulation

140AK-5.0, $V_{IN} = 10V$, $T_A = 25^\circ C$

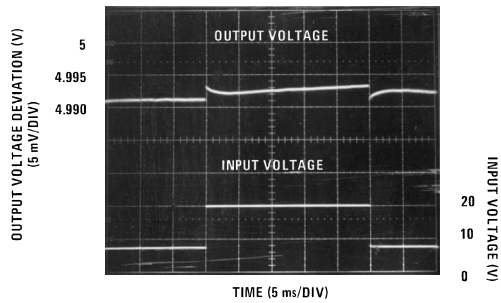

DS007781-6

Equivalent Schematic

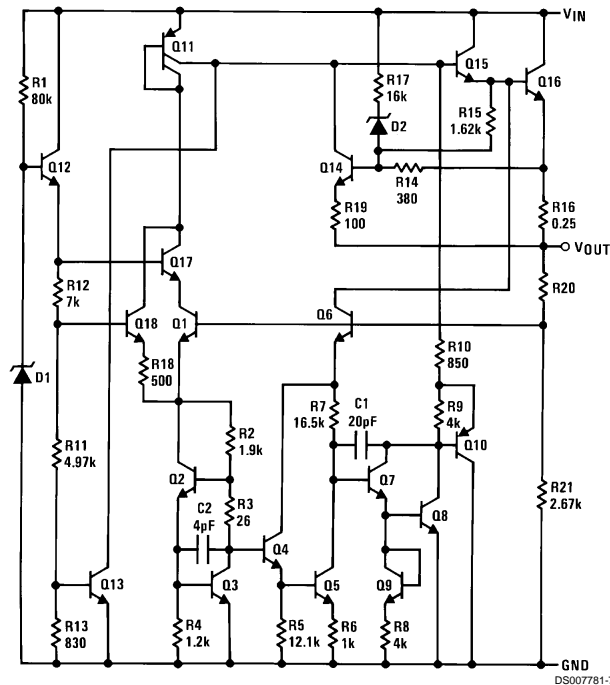

Application Hints

The LM340/LM78XX series is designed with thermal protection, output short-circuit protection and output transistor safe area protection. However, as with any IC regulator, it becomes necessary to take precautions to assure that the regulator is not inadvertently damaged. The following describes possible misapplications and methods to prevent damage to the regulator.

Shorting the Regulator Input: When using large capacitors at the output of these regulators, a protection diode connected input to output (*Figure 1*) may be required if the input is shorted to ground. Without the protection diode, an input

short will cause the input to rapidly approach ground potential, while the output remains near the initial V_{OUT} because of the stored charge in the large output capacitor. The capacitor will then discharge through a large internal input to output diode and parasitic transistors. If the energy released by the capacitor is large enough, this diode, low current metal and the regulator will be destroyed. The fast diode in *Figure 1* will shunt most of the capacitors discharge current around the regulator. Generally no protection diode is required for values of output capacitance $\leq 10 \mu F$.

Raising the Output Voltage above the Input Voltage: Since the output of the device does not sink current, forcing

Application Hints (Continued)

the output high can cause damage to internal low current paths in a manner similar to that just described in the "Shorting the Regulator Input" section.

Regulator Floating Ground (Figure 2): When the ground pin alone becomes disconnected, the output approaches the unregulated input, causing possible damage to other circuits connected to V_{OUT} . If ground is reconnected with power "ON", damage may also occur to the regulator. This fault is most likely to occur when plugging in regulators or modules with on card regulators into powered up sockets. Power should be turned off first, thermal limit ceases operating, or ground should be connected first if power must be left on.

Transient Voltages: If transients exceed the maximum rated input voltage of the device, or reach more than 0.8V below ground and have sufficient energy, they will damage the regulator. The solution is to use a large input capacitor, a series input breakdown diode, a choke, a transient suppressor or a combination of these.

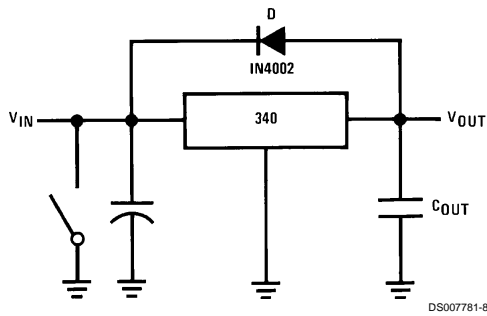

FIGURE 1. Input Short

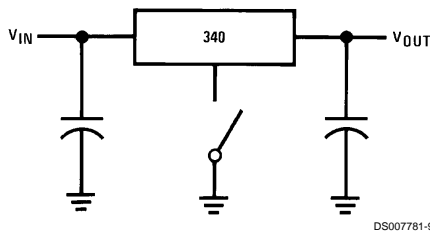

FIGURE 2. Regulator Floating Ground

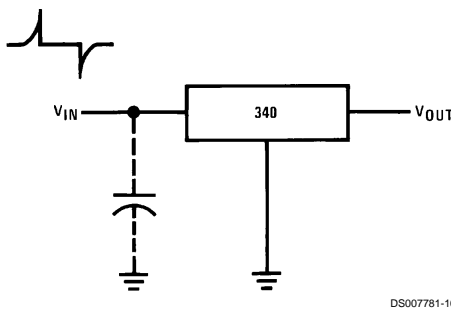

FIGURE 3. Transients

When a value for $\theta_{(H-A)}$ is found using the equation shown, a heatsink must be selected that has a value that is less than or equal to this number.

$\theta_{(H-A)}$ is specified numerically by the heatsink manufacturer in this catalog, or shown in a curve that plots temperature rise vs power dissipation for the heatsink.

HEATSINKING TO-263 AND SOT-223 PACKAGE PARTS

Both the TO-263 ("S") and SOT-223 ("MP") packages use a copper plane on the PCB and the PCB itself as a heatsink. To optimize the heat sinking ability of the plane and PCB, solder the tab of the plane.

shows for the TO-263 the measured values of $\theta_{(J-A)}$ for different copper area sizes using a typical PCB with 1 ounce copper and no solder mask over the copper area used for heatsinking.

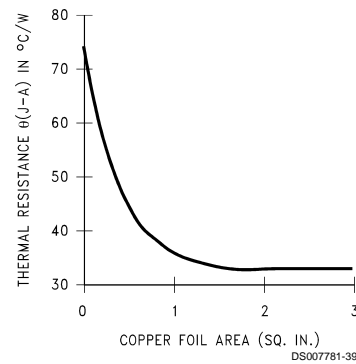

FIGURE 4. $\theta_{(J-A)}$ vs Copper (1 ounce) Area for the TO-263 Package

As shown in the figure, increasing the copper area beyond 1 square inch produces very little improvement. It should also be observed that the minimum value of $\theta_{(J-A)}$ for the TO-263 package mounted to a PCB is 32°C/W.

As a design aid, Figure 5 shows the maximum allowable power dissipation compared to ambient temperature for the TO-263 device (assuming $\theta_{(J-A)}$ is 35°C/W and the maximum junction temperature is 125°C).

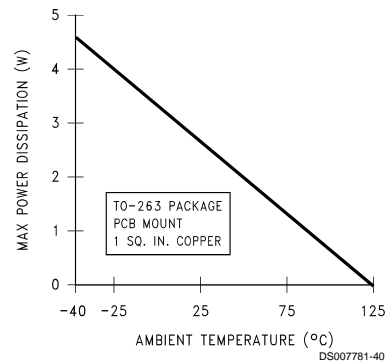

FIGURE 5. Maximum Power Dissipation vs T_{AMB} for the TO-263 Package

Application Hints (Continued)

Figures 6, 7 show the information for the SOT-223 package. Figure 6 assumes a $\theta_{(J-A)}$ of 74°C/W for 1 ounce copper and 51°C/W for 2 ounce copper and a maximum junction temperature of 125°C .

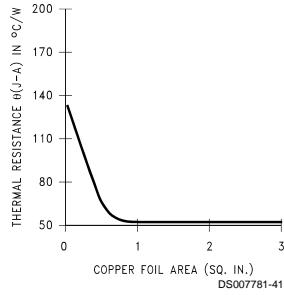

FIGURE 6. $\theta_{(J-A)}$ vs Copper (2 ounce) Area for the SOT-223 Package

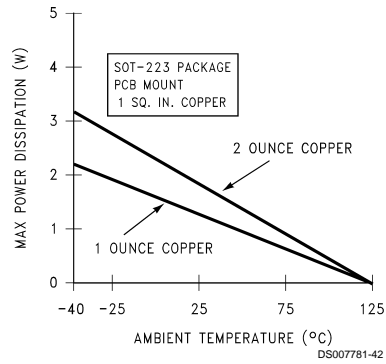
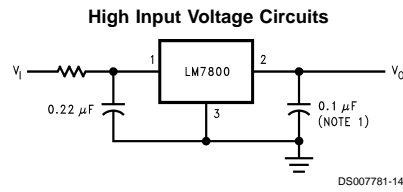
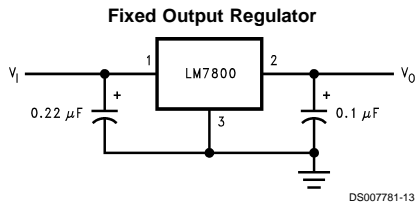

FIGURE 7. Maximum Power Dissipation vs T_{AMB} for the SOT-223 Package

Please see AN-1028 for power enhancement techniques to be used with the SOT-223 package.

Typical Applications



Note: Bypass capacitors are recommended for optimum stability and transient response, and should be located as close as possible to the regulator.

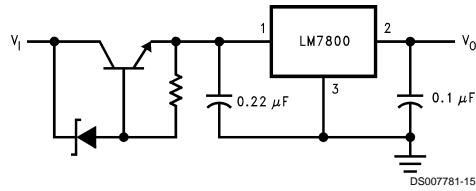

Typical Applications (Continued)

High Current Voltage Regulator

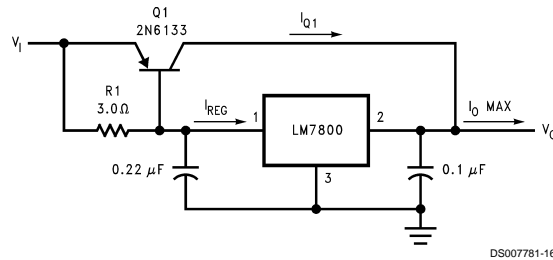

DS007781-16

$$\beta(Q1) \geq \frac{I_{O \text{ Max}}}{I_{\text{REG Max}}}$$

$$R1 = \frac{0.9}{I_{\text{REG}}} = \frac{\beta(Q1) V_{\text{BE}}(Q1)}{I_{\text{REG Max}} (\beta + 1) - I_{O \text{ Max}}}$$

High Output Current, Short Circuit Protected

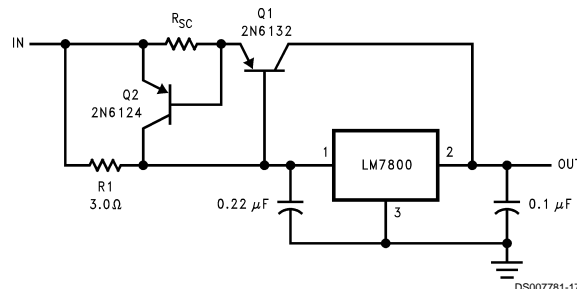

DS007781-17

$$R_{\text{SC}} = \frac{0.8}{I_{\text{SC}}}$$

$$R1 = \frac{\beta V_{\text{BE}}(Q1)}{I_{\text{REG Max}} (\beta + 1) - I_{O \text{ Max}}}$$

Positive and Negative Regulator

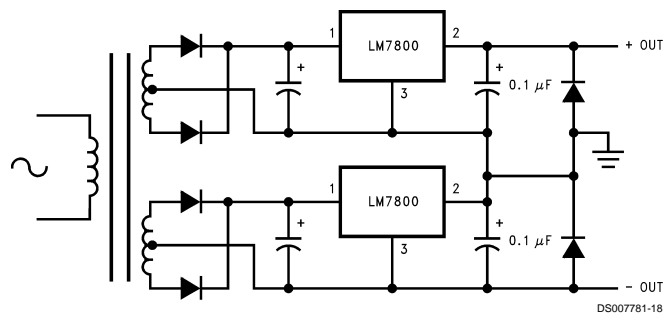

DS007781-18

Connection Diagrams and Ordering Information

TO-3 Metal Can Package (K)

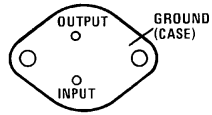

DS007781-11

Bottom View

Steel Package Order Numbers:

LM140K-5.0 LM140K-12 LM140K-15
LM340K-12 LM340K-15
LM340K-5.0

See Package Number K02A

LM140K-5.0/883 LM140K-12/883 LM140K-15/883

See Package Number K02C

TO-220 Power Package (T)

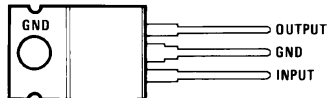

DS007781-12

Top View

Plastic Package Order Numbers:

LM340AT-5.0 LM340T-5.0
LM340T-12 LM340T-15
LM7805CT LM7812CT
LM7815CT LM7808CT

See Package Number T03B

TO-39 Metal Can Package (H)

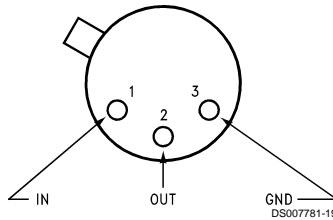

DS007781-19

Top View

Metal Can Order Numbers†:

LM140H-5.0/883 LM140H-6.0/883
LM140H-8.0/883 LM140H-12/883
LM140H-15/883 LM140H-24/883

See Package Number H03A

TO-263 Surface-Mount Package (S)

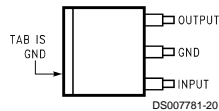

DS007781-20

Top View



DS007781-21

Side View

Surface-Mount Package Order Numbers:

LM340S-5.0 LM340S-12

See Package Number TS3B

3-Lead SOT-223
(Front View)

Order Number LM340MP-5.0

Package Marked NO0A

See Package Number MA04A

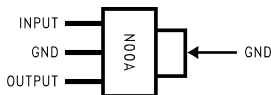

DS007781-43

†The specifications for the LM140H/883 devices are not contained in this datasheet. If specifications for these devices are required, contact the National Semiconductor Sales Office/Distributors.

Physical Dimensions inches (millimeters) unless otherwise noted

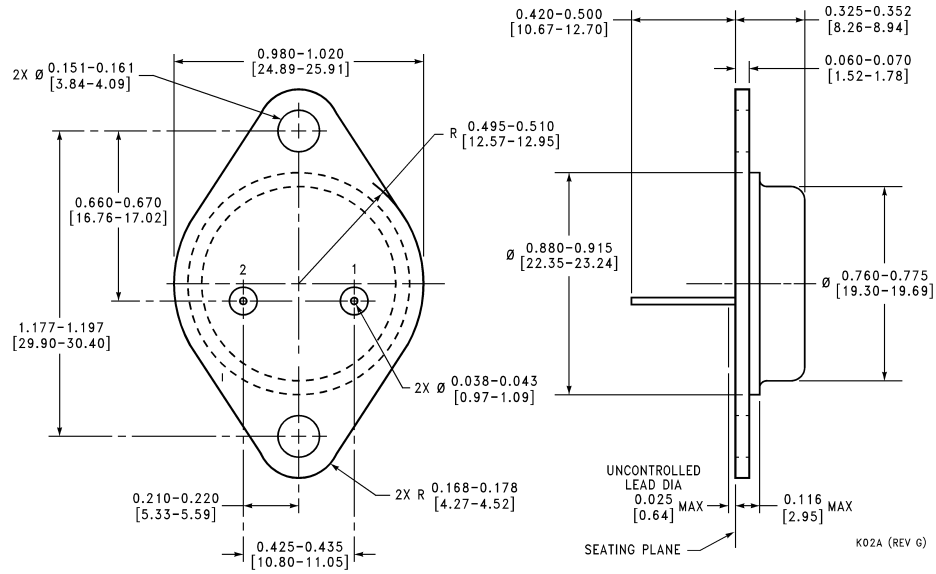

TO-3 Metal Can Package (K)
Order Number LM140K-5.0, LM340K-5.0, LM140K-12, LM340K-12,
LM140K-15, LM340K-15, LM7806CK, LM7808CK, LM7818CK or LM7824CK
NS Package Number K02A

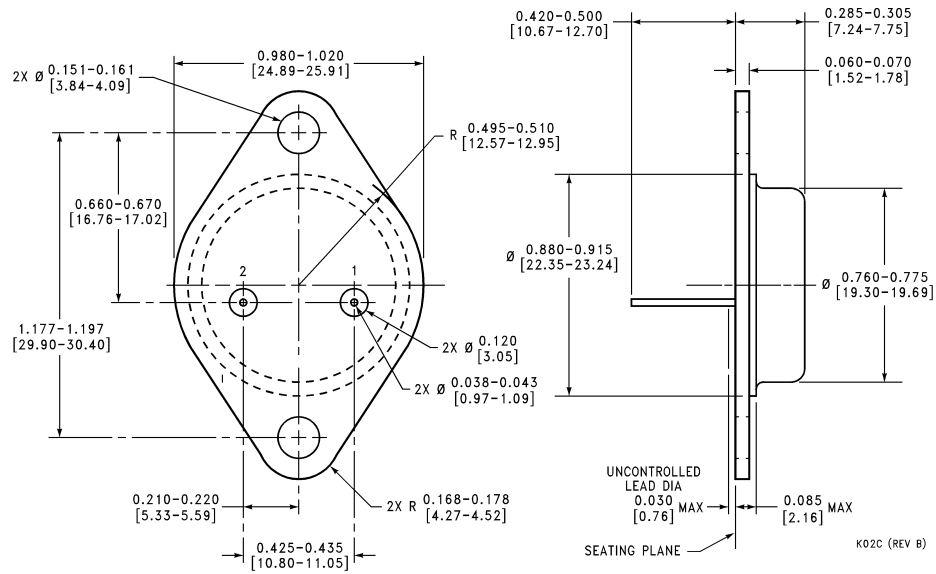

TO-3 Metal Can Package (K)
Mil-Aero Products
Order Number LM140K-5.0/883, LM140K-12/883, or LM140K-15/883
NS Package Number K02C

Physical Dimensions inches (millimeters) unless otherwise noted (Continued)

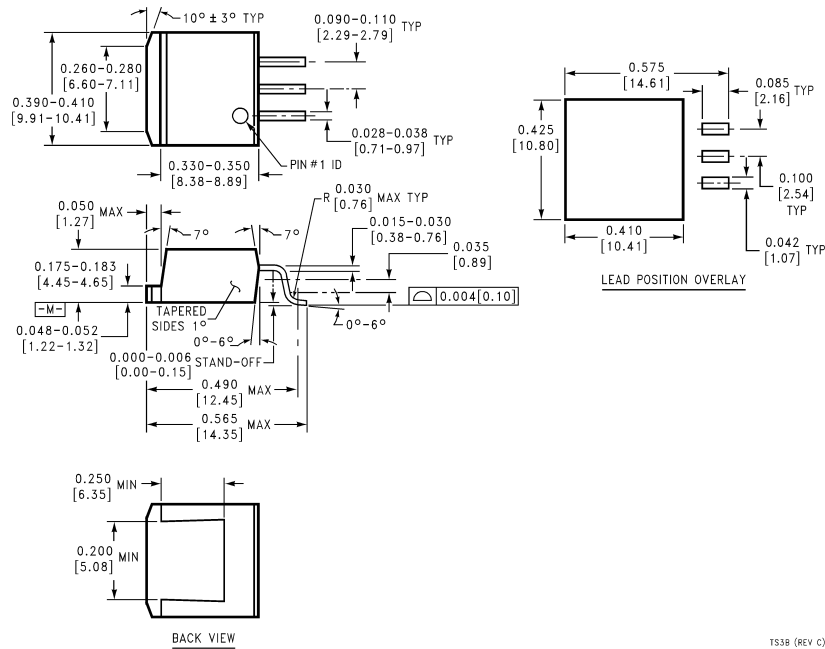

TO-263 Surface-Mount Package (S)
Order Number LM340S-5.0 or LM340S-12
NS Package Number TS3B

TS3B (REV C)

Physical Dimensions inches (millimeters) unless otherwise noted (Continued)

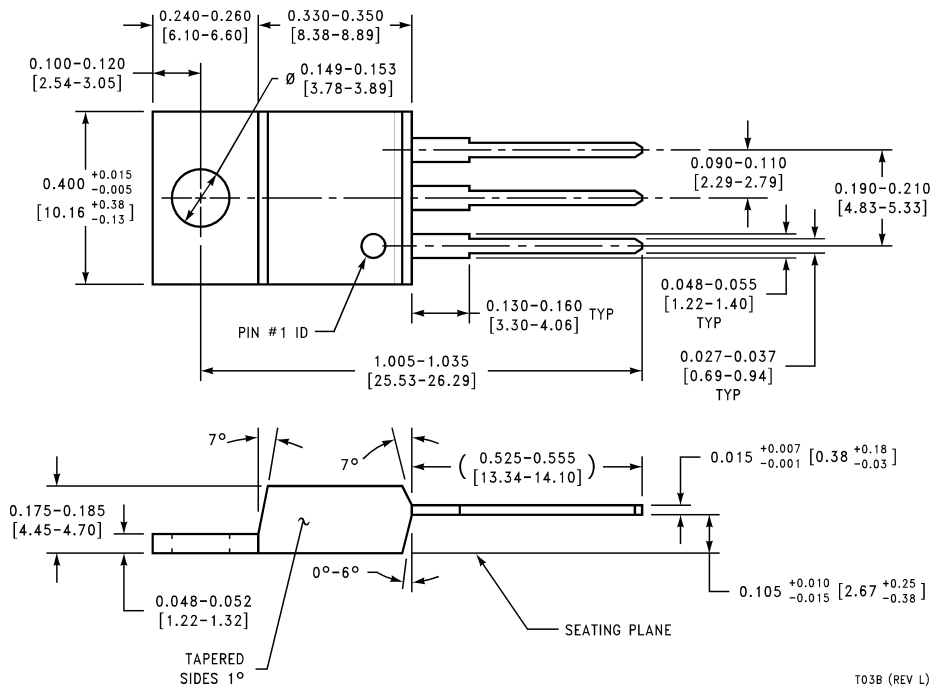

T03B (REV L)

TO-220 Power Package (T)
Order Number LM340AT/LM340T-5.0, LM340AT/LM340T-12, LM340AT/LM340T-15,
LM7805CT, LM7812CT, LM7815CT, LM7806CT, LM7808CT, LM7818CT or LM7824CT
NS Package Number T03B

Physical Dimensions inches (millimeters) unless otherwise noted (Continued)

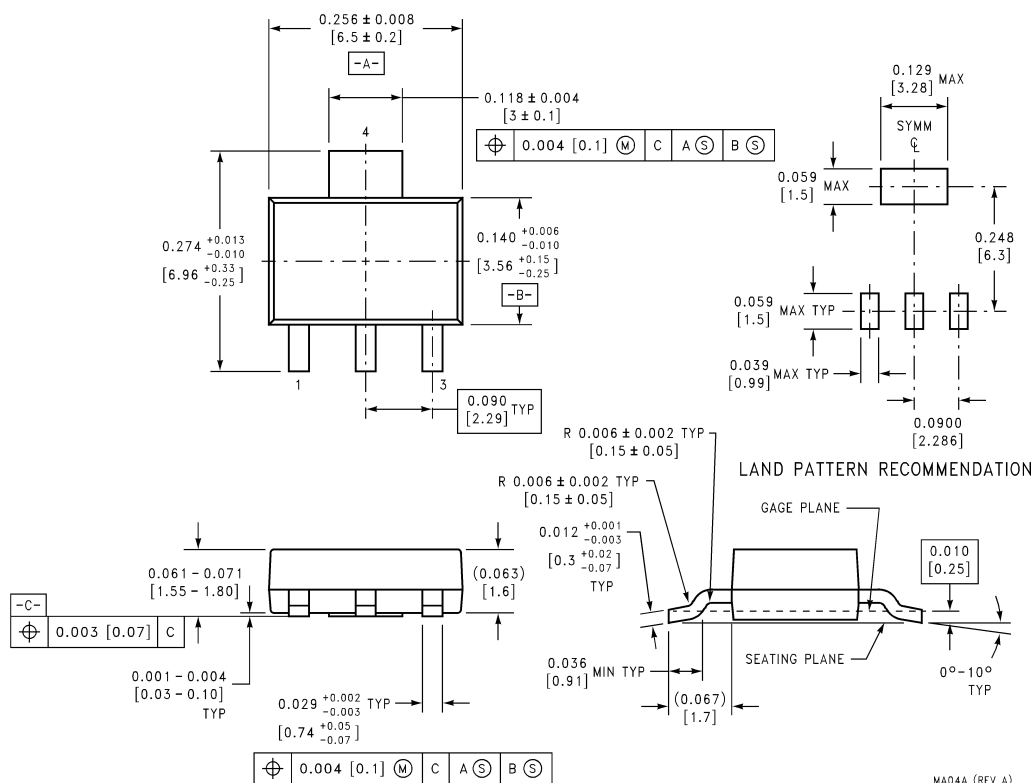

3-Lead SOT-223 Package
Order Part Number LM340MP-5.0
NS Package Number MA04A

MA04A (REV A)

LIFE SUPPORT POLICY

NATIONAL'S PRODUCTS ARE NOT AUTHORIZED FOR USE AS CRITICAL COMPONENTS IN LIFE SUPPORT DEVICES OR SYSTEMS WITHOUT THE EXPRESS WRITTEN APPROVAL OF THE PRESIDENT AND GENERAL COUNSEL OF NATIONAL SEMICONDUCTOR CORPORATION. As used herein:

1. Life support devices or systems are devices or systems which, (a) are intended for surgical implant into the body, or (b) support or sustain life, and whose failure to perform when properly used in accordance with instructions for use provided in the labeling, can be reasonably expected to result in a significant injury to the user.
2. A critical component is any component of a life support device or system whose failure to perform can be reasonably expected to cause the failure of the life support device or system, or to affect its safety or effectiveness.



National Semiconductor Corporation
 Americas
 Tel: 1-800-272-9959
 Fax: 1-800-737-7018
 Email: support@nsc.com

National Semiconductor Europe
 Fax: +49 (0) 1 80-530 85 86
 Email: europe.support@nsc.com
 Deutsch Tel: +49 (0) 1 80-530 85 85
 English Tel: +49 (0) 1 80-532 78 32
 Français Tel: +49 (0) 1 80-532 93 58
 Italiano Tel: +49 (0) 1 80-534 16 80

National Semiconductor Asia Pacific Customer Response Group
 Tel: 65-2544466
 Fax: 65-2504466
 Email: sea.support@nsc.com

National Semiconductor Japan Ltd.
 Tel: 81-3-5639-7560
 Fax: 81-3-5639-7507

www.national.com