

LM6152/LM6154 Dual and Quad High Speed/Low Power 75 MHz GBW Rail-to-Rail I/O Operational Amplifiers

General Description

Using patented circuit topologies, the LM6152/54 provides new levels of speed vs. power performance in applications where low voltage supplies or power limitations previously made compromise necessary. With only 1.4 mA/amplifier supply current, the 75 MHz gain bandwidth of this device supports new portable applications where higher power devices unacceptably drain battery life. The slew rate of the devices increases with increasing input differential voltage, thus allowing the device to handle capacitive loads while maintaining large signal amplitude.

The LM6152/54 can be driven by voltages that exceed both power supply rails, thus eliminating concerns about exceeding the common-mode voltage range. The rail-to-rail output swing capability provides the maximum possible dynamic range at the output. This is particularly important when operating on low supply voltages.

Operating on supplies from 2.7V to over 24V, the LM6152/54 is excellent for a very wide range of applications, from battery operated systems with large bandwidth requirements to high speed instrumentation.

Features

At $V_S = 5V$, Typ unless noted

- Greater than Rail-to-Rail Input CMVR $-0.25V$ to $5.25V$
- Rail-to-Rail Output Swing $0.01V$ to $4.99V$
- Wide Gain-Bandwidth: $75\text{ MHz @ }100\text{ kHz}$
- Slew Rate:
 - Small signal $5V/\mu s$
 - Large signal $45V/\mu s$
- Low supply current $1.4mA/\text{amplifier}$
- Wide supply range $2.7V$ to $24V$
- Fast settling time of $1.1\mu s$ for $2V$ step (to 0.01%)
- PSRR 91 dB
- CMRR 84 dB

Applications

- Portable high speed instrumentation
- Signal conditioning amplifier/ADC buffers
- Barcode scanners

Connection Diagrams

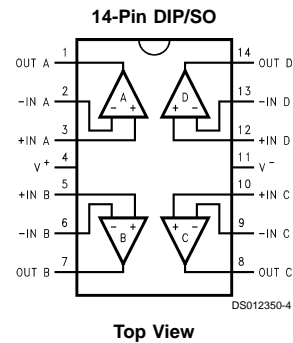
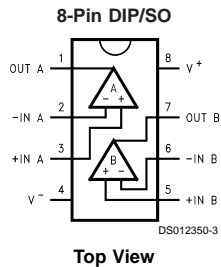

Ordering Information

Packaged	Ordering Information	NSC Drawing Number	Supplied As
8-Pin Dip	LM6152ACN, LM5152BCN	N08E	Rails
8-Pin SOIC	LM6152ACM, LM6152BCM	M08A	Rails
	LM6152ACMX, LM6152BCMX	M08A	2.5k Tape and Reel
14-Pin DIP	LM6154ACN, LM6154BCN	N14A	Rails
14-Pin SOIC	LM6154ACM, LM6154BCM	M14A	Rails
	LM6154ACMX, LM6154BCMX	M14A	2.5k Tape and Reel

Absolute Maximum Ratings (Note 1)

If Military/Aerospace specified devices are required, please contact the National Semiconductor Sales Office/Distributors for availability and specifications.

ESD Tolerance (Note 2)	2500V
Differential Input Voltage	15V
Voltage at Input/Output Pin	(V ⁺) + 0.3V, (V ⁻) -0.3V
Supply Voltage (V ⁺ - V ⁻)	35V
Current at Input Pin	±10mA
Current at Output Pin (Note 3)	±25mA
Current at Power Supply Pin	50mA
Lead Temperature (soldering, 10 sec)	260°C

Storage Temperature Range	-65°C to +150°C
Junction Temperature (Note 4)	150°C

Operating Ratings (Note 1)

Supply Voltage	2.7V ≤ V _S ≤ 24V
Junction Temperature Range	0°C ≤ T _J ≤ +70°C
LM6152, LM6154	
Thermal Resistance (θ _{JA})	
N Pkg, 8-pin Molded Dip	115°C/W
M Pkg, 8-pin Surface Mount	193°C/W
N Pkg, 14-pin Molded Dip	81°C/W
M Pkg, 14-pin Surface Mount	126°C/W

5.0V DC Electrical Characteristics

Unless otherwise specified, all limits guaranteed for T_J = 25°C, V⁺ = 5.0V, V⁻ = 0V, V_{CM} = V_O = V⁺/2 and R_L > 1 MΩ to V⁺/2. **Boldface** limits apply at the temperature extremes.

Symbol	Parameter	Conditions	Typ (Note 5)	LM6154AC LM6152AC Limit (Note 6)	LM6154BC LM6152BC Limit (Note 6)	Units
V _{OS}	Input Offset Voltage		0.54	2 4	5 7	mV max
TCV _{OS}	Input Offset Voltage Average Drift		10			μV/°C
I _B	Input Bias Current	0V ≤ V _{CM} ≤ 5V	500 750	980 1500	980 1500	nA max
I _{OS}	Input Offset Current		32 40	100 160	100 160	nA max
R _{IN}	Input Resistance, CM	0V ≤ V _{CM} ≤ 4V	30			MΩ
CMRR	Common Mode Rejection Ratio	0V ≤ V _{CM} ≤ 4V	94	70	70	dB min
		0V ≤ V _{CM} ≤ 5V	84	60	60	
PSRR	Power Supply Rejection Ratio	5V ≤ V ⁺ ≤ 24V	91	80	80	dB min
V _{CM}	Input Common-Mode Voltage Range	Low	-0.25	0	0	V
		High	5.25	5.0	5.0	V
A _V	Large Signal Voltage Gain	R _L = 10kΩ	214	50	50	V/mV min
V _O	Output Swing	R _L = 100kΩ	0.006	0.02 0.03	0.02 0.03	V max
			4.992	4.97 4.96	4.97 4.96	V min
		R _L = 2kΩ	0.04	0.10 0.12	0.10 0.12	V max
			4.89	4.80 4.70	4.80 4.70	V min
I _{SC}	Output Short Circuit Current	Sourcing	6.2	3 2.5	3 2.5	mA min
				27 17	27 17	mA max
		Sinking	16.9	7 5	7 5	mA min
				40	40	mA max

5.0V DC Electrical Characteristics (Continued)

Unless otherwise specified, all limits guaranteed for $T_J = 25^\circ\text{C}$, $V^+ = 5.0\text{V}$, $V^- = 0\text{V}$, $V_{\text{CM}} = V_O = V^+/2$ and $R_L > 1\text{M}\Omega$ to $V^+/2$. **Boldface** limits apply at the temperature extremes.

Symbol	Parameter	Conditions	Typ (Note 5)	LM6154AC LM6152AC Limit (Note 6)	LM6154BC LM6152BC Limit (Note 6)	Units
I_S	Supply Current	Per Amplifier	1.4	2 2.25	2 2.25	mA max

5.0V AC Electrical Characteristics

Unless otherwise specified, all limits guaranteed for $T_J = 25^\circ\text{C}$, $V^+ = 5.0\text{V}$, $V^- = 0\text{V}$, $V_{\text{CM}} = V_O = V^+/2$ and $R_L > 1\text{M}\Omega$ to $V^+/2$. **Boldface** limits apply at the temperature extremes.

Symbol	Parameter	Conditions	Typ (Note 5)	LM6154AC LM6152AC Limit (Note 6)	LM6154BC LM6152BC Limit (Note 6)	Units
SR	Slew Rate	$\pm 4\text{V Step @ } V_S = \pm 6\text{V}$, $R_S < 1\text{ k}\Omega$	30	24 15	24 15	V/ μs min
GBW	Gain-Bandwidth Product	$f = 100\text{ kHz}$	75			MHz
	Amp-to-Amp Isolation	$R_L = 10\text{ k}\Omega$	125			dB
e_n	Input-Referred Voltage Noise	$f = 1\text{ kHz}$	9			$\text{nV}/\sqrt{\text{Hz}}$
i_n	Input-Referred Current Noise	$f = 1\text{ kHz}$	0.34			$\text{pA}/\sqrt{\text{Hz}}$
T.H.D	Total Harmonic Distortion	$f = 10\text{ kHz}$, $R_L = 10\text{ k}\Omega$	0.002			%
t_s	Settling Time	2V Step to 0.01%	1.1			μs

2.7V DC Electrical Characteristics

Unless otherwise specified, all limits guaranteed for $T_J = 25^\circ\text{C}$, $V^+ = 2.7\text{V}$, $V^- = 0\text{V}$, $V_{\text{CM}} = V_O = V^+/2$ and $R_L > 1\text{M}\Omega$ to $V^+/2$. **Boldface** limits apply at the temperature extremes.

Symbol	Parameter	Conditions	Typ (Note 5)	LM6154AC LM6152AC Limit (Note 6)	LM6154BC LM6152BC Limit (Note 6)	Units
V_{OS}	Input Offset Voltage		0.8	2 5	5 8	mV max
TCV_{OS}	Input Offset Voltage Average Drift		10			$\mu\text{V}/^\circ\text{C}$
I_B	Input Bias Current		500			nA
I_{OS}	Input Offset Current		50			nA
R_{IN}	Input Resistance, CM	$0\text{V} \leq V_{\text{CM}} \leq 1.8\text{V}$	30			$\text{M}\Omega$
CMRR	Common Mode Rejection Ratio	$0\text{V} \leq V_{\text{CM}} \leq 1.8\text{V}$	88			dB
		$0\text{V} \leq V_{\text{CM}} \leq 2.7\text{V}$	78			
PSRR	Power Supply Rejection Ratio	$3\text{V} \leq V^+ \leq 5\text{V}$	69			dB
V_{CM}	Input Common-Mode Voltage Range	Low	-0.25	0	0	V
		High	2.95	2.7	2.7	V
A_V	Large Signal Voltage Gain	$R_L = 10\text{ k}\Omega$	5.5			V/mV
V_O	Output Swing	$R_L = 10\text{ k}\Omega$	0.032	0.07 0.11	0.07 0.11	V max
			2.68	2.64 2.62	2.64 2.62	V min
I_S	Supply Current	Per Amplifier	1.35			mA

2.7V AC Electrical Characteristics

Unless otherwise specified, all limits guaranteed for $T_J = 25^\circ\text{C}$, $V^+ = 2.7\text{V}$, $V^- = 0\text{V}$, $V_{\text{CM}} = V_O = V^+/2$ and $R_L > 1\text{ M}\Omega$ to $V^+/2$. **Boldface** limits apply at the temperature extremes.

Symbol	Parameter	Conditions	Typ (Note 5)	LM6154AC LM6152AC Limit (Note 6)	LM6154BC LM6152BC Limit (Note 6)	Units
GBW	Gain-Bandwidth Product	$f = 100\text{kHz}$	80			MHz

24V DC Electrical Characteristics

Unless otherwise specified, all limits guaranteed for $T_J = 25^\circ\text{C}$, $V^+ = 24\text{V}$, $V^- = 0\text{V}$, $V_{\text{CM}} = V_O = V^+/2$ and $R_L > 1\text{ M}\Omega$ to $V^+/2$. **Boldface** limits apply at the temperature extremes.

Symbol	Parameter	Conditions	Typ (Note 5)	LM6154AC LM6152AC Limit (Note 6)	LM6154BC LM6152BC Limit (Note 6)	Units
V_{OS}	Input Offset Voltage		0.3	2 4	7 9	mV max
TCV_{OS}	Input Offset Voltage Average Drift		10			$\mu\text{V}/^\circ\text{C}$
I_{B}	Input Bias Current		500			nA
I_{OS}	Input Offset Current		32			nA
R_{IN}	Input Resistance, CM	$0\text{V} \leq V_{\text{CM}} \leq 23\text{V}$	60			Meg Ω
CMRR	Common Mode Rejection Ratio	$0\text{V} \leq V_{\text{CM}} \leq 23\text{V}$	94			dB
		$0\text{V} \leq V_{\text{CM}} \leq 24\text{V}$	84			
PSRR	Power Supply Rejection Ratio	$0\text{V} \leq V_{\text{CM}} \leq 24\text{V}$	95			dB
V_{CM}	Input Common-Mode Voltage Range	Low	-0.25	0	0	V
		High	24.25	24	24	V
A_V	Large Signal Voltage Gain	$R_L = 10\text{k}\Omega$	55			V/mV
V_O	Output Swing	$R_L = 10\text{k}\Omega$	0.044	0.075 0.090	0.075 0.090	V max
			23.91	23.8 23.7	23.8 23.7	V min
I_{S}	Supply Current	Per Amplifier	1.6	2.25 2.50	2.25 2.50	mA max

24V AC Electrical Characteristics

Unless otherwise specified, all limits guaranteed for $T_J = 25^\circ\text{C}$, $V^+ = 24\text{V}$, $V^- = 0\text{V}$, $V_{\text{CM}} = V_O = V^+/2$ and $R_L > 1\text{ M}\Omega$ to $V^+/2$. **Boldface** limits apply at the temperature extremes.

Symbol	Parameter	Conditions	Typ (Note 5)	LM6154AC LM6152AC Limit (Note 6)	LM6154BC LM6152BC Limit (Note 6)	Units
GBW	Gain-Bandwidth Product	$f = 100\text{kHz}$	80			MHz

Note 1: Absolute Maximum Ratings indicate limits beyond which damage to the device may occur. Operating Ratings indicate conditions for which the device is intended to be functional, but specific performance is not guaranteed. For guaranteed specifications and the test conditions, see the Electrical Characteristics.

Note 2: Human body model, 1.5k Ω in series with 100pF.

Note 3: Applies to both single-supply and split-supply operation. Continuous short circuit operation at elevated ambient temperature can result in exceeding the maximum allowed junction temperature of 150°C.

Note 4: The maximum power dissipation is a function of $T_{\text{J(max)}}$, θ_{JA} , and T_{A} . The maximum allowable power dissipation at any ambient temperature is $P_{\text{D}} = (T_{\text{J(max)}} - T_{\text{A}})/\theta_{\text{JA}}$. All numbers apply for packages soldered directly into a PC board.

Note 5: Typical Values represent the most likely parametric norm.

Note 6: All limits are guaranteed by testing or statistical analysis.

Typical Performance Characteristics

Supply Current vs. Supply Voltage

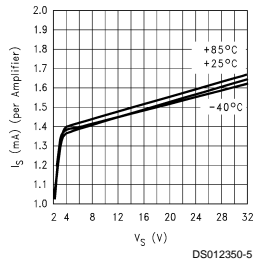

Offset Voltage vs. Supply Voltage

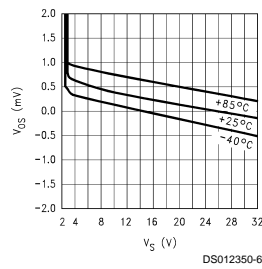

Bias Current vs. Supply Voltage

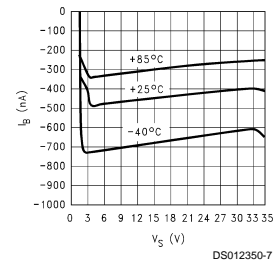

Bias Current vs. VCM

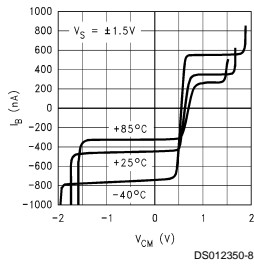

Bias Current vs. VCM

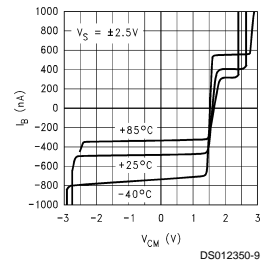

Bias Current vs. VCM

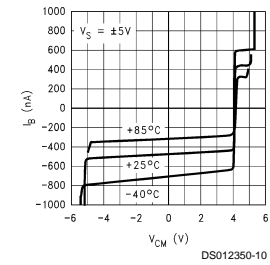

Output Voltage vs. Source Current

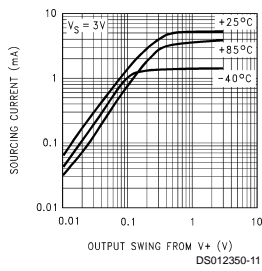

Output Voltage vs. Source Current

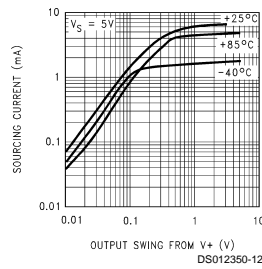

Output Voltage vs. Source Current

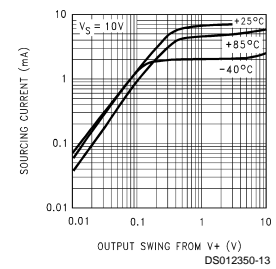

Output Voltage vs. Sink Current

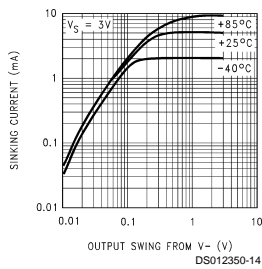

Output Voltage vs. Sink Current

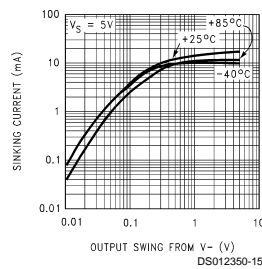

Output Voltage vs. Sink Current

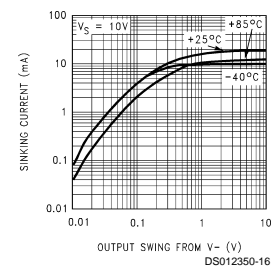

Typical Performance Characteristics (Continued)

Crosstalk (dB vs. Frequency

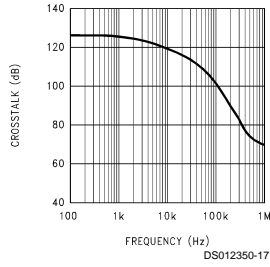

GBWP (@ 100 kHz) vs. Supply Voltage

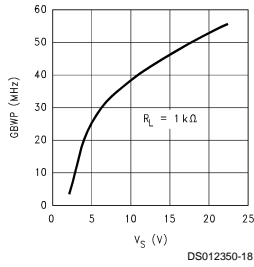

Unity Gain Frequency vs. Supply Voltage for Various Loads

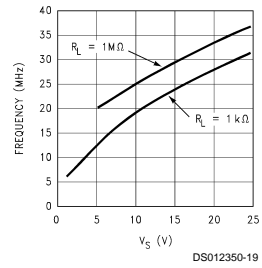

CMRR

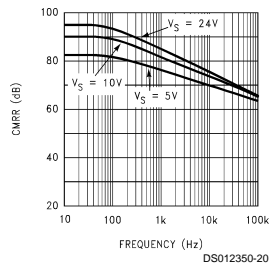

Voltage Swing vs. Frequency (CL = 100 pF)

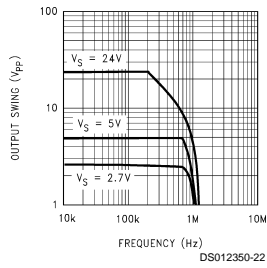

PSRR vs. Frequency

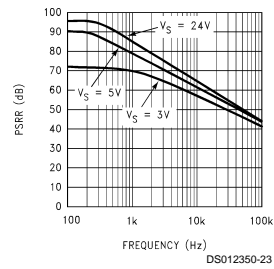

Open Loop Gain/Phase (VS = 5V)

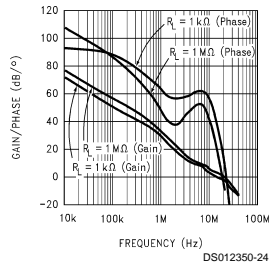

Open Loop Gain/Phase (VS = 10V)

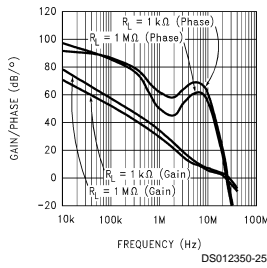

Open Loop Gain/Phase (VS = 24V)

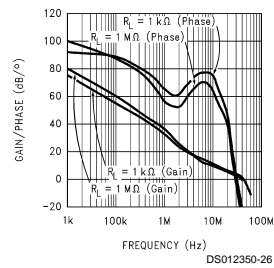

Noise Voltage vs. Frequency

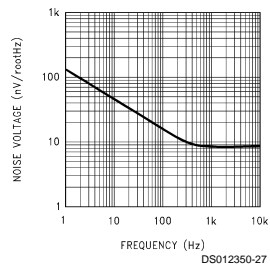

Noise Current vs. Frequency

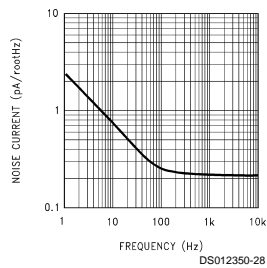

Voltage Error vs. Settle Time

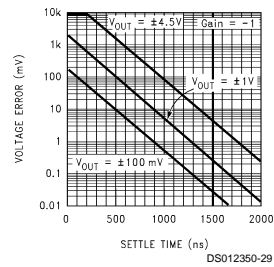

Typical Performance Characteristics (Continued)

Total Harmonic Distortion vs. Frequency

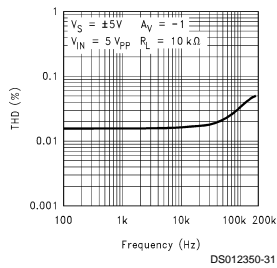

Application Information

The LM6152/6154 is ideally suited for operation with about 10kΩ (Feedback Resistor, R_F) between the output and the negative input terminal.

With R_F set to this value, for most applications requiring a close loop gain of 10 or less, an additional small compensation capacitor (C_F) (see Figure 1) is recommended across R_F in order to achieve a reasonable overshoot (10%) at the output by compensating for stray capacitance across the inputs.

The optimum value for C_F can best be established experimentally with a trimmer cap in place since its value is dependant on the supply voltage, output driving load, and the operating gain. Below, some typical values used in an inverting configuration and driving a 10kΩ load have been tabulated for reference:

TABLE 1. Typical BW (-3 dB) at Various Supply Voltage and Gains

V_S Volts	Gain	C_F pF	BW (-3 dB) MHz
3	-1	5.6	4
	-10	6.8	1.97
	-100	None	0.797
24	-1	2.2	6.6
	-10	4.7	2.2
	-100	None	0.962

In the non-inverting configuration, the LM6152/6154 can be used for closed loop gains of +2 and above. In this case, also, the compensation capacitor (C_F) is recommended across R_F (= 10kΩ) for gains of 10 or less.

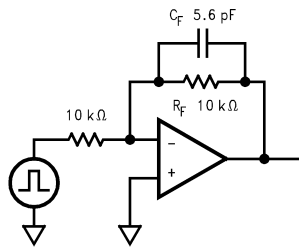

FIGURE 1. Typical Inverting Gain Circuit $A_V = -1$

Because of the unique structure of this amplifier, when used at low closed loop gains, the realizable BW will be much less than the GBW product would suggest.

The LM6152/6154 brings a new level of ease of use to op amp system design.

The greater than rail-to-rail input voltage range eliminates concern over exceeding the common-mode voltage range. The rail-to-rail output swing provides the maximum possible dynamic range at the output. This is particularly important when operating on low supply voltages.

The high gain-bandwidth with low supply current opens new battery powered applications where higher power consumption previously reduced battery life to unacceptable levels.

The ability to drive large capacitive loads without oscillating functional removes this common problem.

To take advantage of these features, some ideas should be kept in mind.

The LM6152/6154, capacitive loads do not lead to oscillations, in all but the most extreme conditions, but they will result in reduced bandwidth. They also cause increased settling time.

Unlike most bipolar op amps, the unique phase reversal prevention/speed-up circuit in the input stage, caused the slew rate to be very much a function of the input pulse amplitude. This results in a 10 to 1 increase in slew rate when the differential input signal increases. Large fast pulses will raise the slew-rate to more than 30V/μs.

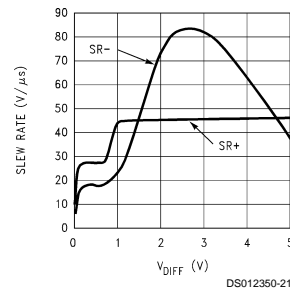

FIGURE 2. Slew Rate vs. V_{DIFF}

The speed-up action adds stability to the system when driving large capacitive loads.

A conventional op amp exhibits a fixed maximum slew-rate even though the differential input voltage rises due to the lagging output voltage. In the LM6152/6154, increasing lag causes the differential input voltage to increase but as it does, the increased slew-rate keeps the output following the input much better. This effectively reduces phase lag. As a result, the LM6152/6154 can drive capacitive loads as large as 470 pF at gain of 2 and above, and not oscillate.

Capacitive loads decrease the phase margin of all op amps. This can lead to overshoot, ringing and oscillation. This is caused by the output resistance of the amplifier and the load capacitance forming an R-C phase shift network. The LM6152/6154 senses this phase shift and partly compensates for this effect.

Physical Dimensions inches (millimeters) unless otherwise noted

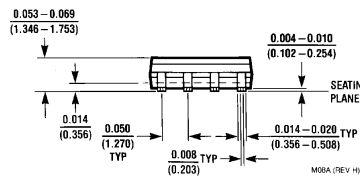
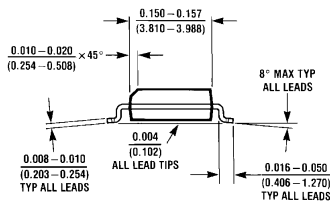
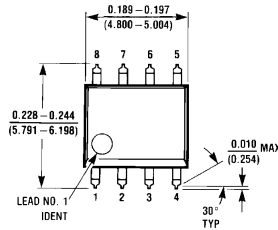

8-Lead (0.150") Molded Small Outline Package, JEDEC
Ordering Number LM6152ACM or LM7162BCM
NSC Package Number M08A

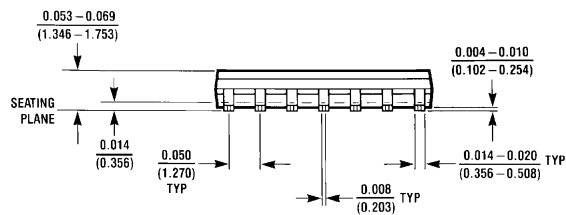
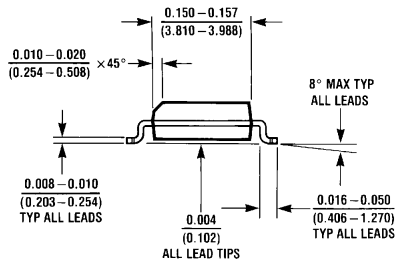
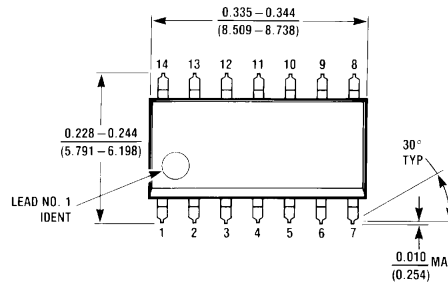

14-Lead (0.150") Molded Small Outline Package, JEDEC
Order Number LM6154ACM or LM6154BCM
NSC Package Number M14A

Physical Dimensions inches (millimeters) unless otherwise noted (Continued)

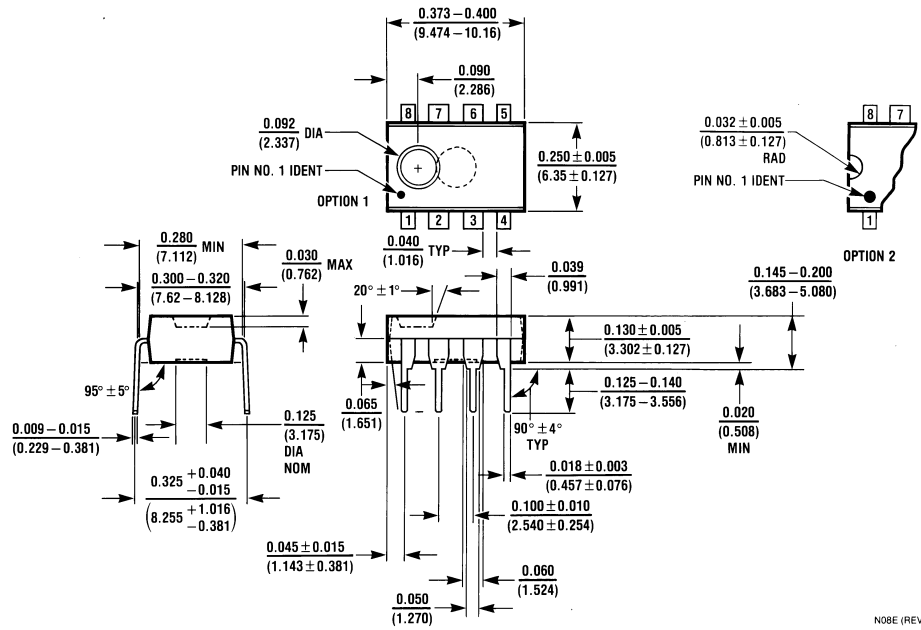

**8-Lead (0.300" Wide) Molded Dual-In-Line Package, JEDEC
Order Number LM615ACN or LM6152BCN
NSC Package Number N08E**

N08E (REV F)

Physical Dimensions inches (millimeters) unless otherwise noted (Continued)

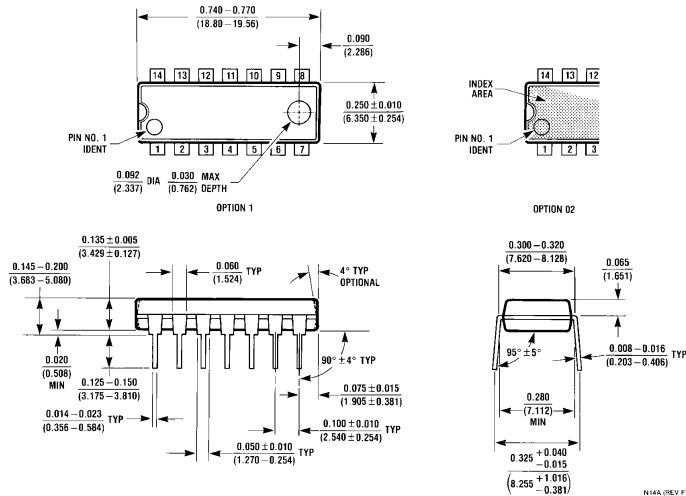

**14-Lead (0.300" Wide) Molded Dual-In-Line Package, JEDEC
Order Number LM6154ACN or LM6154BCN
NSC Package Number N14A**

LIFE SUPPORT POLICY

NATIONAL'S PRODUCTS ARE NOT AUTHORIZED FOR USE AS CRITICAL COMPONENTS IN LIFE SUPPORT DEVICES OR SYSTEMS WITHOUT THE EXPRESS WRITTEN APPROVAL OF THE PRESIDENT AND GENERAL COUNSEL OF NATIONAL SEMICONDUCTOR CORPORATION. As used herein:

1. Life support devices or systems are devices or systems which, (a) are intended for surgical implant into the body, or (b) support or sustain life, and whose failure to perform when properly used in accordance with instructions for use provided in the labeling, can be reasonably expected to result in a significant injury to the user.
2. A critical component is any component of a life support device or system whose failure to perform can be reasonably expected to cause the failure of the life support device or system, or to affect its safety or effectiveness.

National Semiconductor Corporation
Americas
Tel: 1-800-272-9959
Fax: 1-800-737-7018
Email: support@nsc.com

National Semiconductor Europe
Fax: +49 (0) 1 80-530 85 86
Email: europe.support@nsc.com
Deutsch Tel: +49 (0) 1 80-530 85 85
English Tel: +49 (0) 1 80-532 78 32
Français Tel: +49 (0) 1 80-532 93 58
Italiano Tel: +49 (0) 1 80-534 16 80

National Semiconductor Asia Pacific Customer Response Group
Tel: 65-2544466
Fax: 65-2504466
Email: sea.support@nsc.com

National Semiconductor Japan Ltd.
Tel: 81-3-5639-7560
Fax: 81-3-5639-7507

www.national.com