

# Darlington Amplifier Transistors

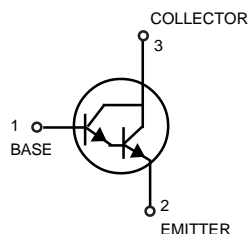

**LMBTA13LT1**  
**LMBTA14LT1**

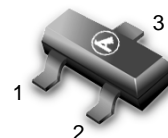

**SOT-23**

## MAXIMUM RATINGS

Rating	Symbol	Value	Unit
Collector–Emitter Voltage	$V_{CES}$	30	Vdc
Collector–Base Voltage	$V_{CBO}$	30	Vdc
Emitter–Base Voltage	$V_{EBO}$	10	Vdc
Collector Current — Continuous	$I_C$	300	mAdc

## THERMAL CHARACTERISTICS

Characteristic	Symbol	Max	Unit
Total Device Dissipation FR–5 Board, (1) $T_A = 25^\circ\text{C}$	$P_D$	225	mW
Derate above $25^\circ\text{C}$		1.8	mW/ $^\circ\text{C}$
Thermal Resistance, Junction to Ambient	$R_{\theta JA}$	556	$^\circ\text{C}/\text{W}$
Total Device Dissipation Alumina Substrate, (2) $T_A = 25^\circ\text{C}$	$P_D$	300	mW
Derate above $25^\circ\text{C}$		2.4	mW/ $^\circ\text{C}$
Thermal Resistance, Junction to Ambient	$R_{\theta JA}$	417	$^\circ\text{C}/\text{W}$
Junction and Storage Temperature	$T_J, T_{stg}$	–55 to +150	$^\circ\text{C}$

## DEVICE MARKING

LMBTA13LT1 = 1M; LMBTA14LT1 = 1N

## ELECTRICAL CHARACTERISTICS ( $T_A = 25^\circ\text{C}$ unless otherwise noted.)

Characteristic	Symbol	Min	Max	Unit
----------------	--------	-----	-----	------

## OFF CHARACTERISTICS

Collector–Emitter Breakdown Voltage ( $I_C = 100 \mu\text{Adc}, V_{BE} = 0$ )	$V_{(BR)CEO}$	30	—	Vdc
Collector Cutoff Current ( $V_{CB} = 30\text{Vdc}, I_E = 0$ )	$I_{CBO}$	—	100	nAdc
Emitter Cutoff Current ( $V_{EB} = 10\text{Vdc}, I_C = 0$ )	$I_{EBO}$	—	100	nAdc

1. FR–5 = 1.0 x 0.75 x 0.062 in.

2. Alumina = 0.4 x 0.3 x 0.024 in. 99.5% alumina.

**LMBTA13LT1 LMBTA14LT1**

**ELECTRICAL CHARACTERISTICS** ( $T_A = 25^\circ\text{C}$  unless otherwise noted) (Continued)

Characteristic	Symbol	Min	Max	Unit
<b>ON CHARACTERISTICS (3)</b>				
DC Current Gain ( $I_C = 10 \text{ mAdc}$ , $V_{CE} = 5.0 \text{ Vdc}$ )	$h_{FE}$	5,000	—	—
	LMBTA13	5,000	—	—
	LMBTA14	10,000	—	—
( $I_C = 100\text{mAdc}$ , $V_{CE} = 5.0\text{Vdc}$ )	LMBTA13	10,000	—	—
	LMBTA14	20,000	—	—
Collector–Emitter Saturation Voltage ( $I_C = 100 \text{ mAdc}$ , $I_B = 0.1 \text{ mAdc}$ )	$V_{CE(sat)}$	—	1.5	Vdc
Base–Emitter On Voltage ( $I_C = 100\text{mAdc}$ , $V_{CE} = 5.0\text{Vdc}$ )	$V_{BE}$	—	2.0	Vdc

**SMALL–SIGNAL CHARACTERISTICS**

Current – Gain–Bandwidth Product(4) ( $V_{CE} = 5.0 \text{ Vdc}$ , $I_C = 10\text{mAdc}$ , $f = 100 \text{ MHz}$ )	$f_T$	125	—	MHz
-----------------------------------------------------------------------------------------------------------------------	-------	-----	---	-----

3. Pulse Test: Pulse Width  $\leq 300 \mu\text{s}$ , Duty Cycle  $\leq 2.0\%$ .

4.  $f_T = |h_{fe}| * f_{test}$ .

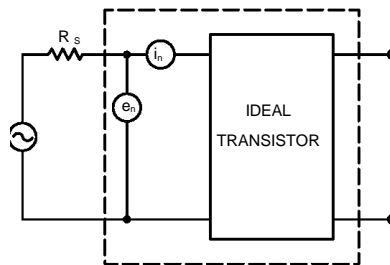
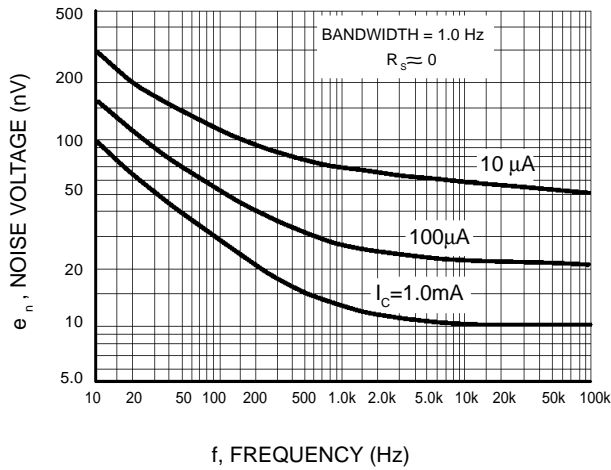

**Figure 1. Transistor Noise Model**

**LMBTA13LT1 LMBTA14LT1**

**NOISE CHARACTERISTICS**

( $V_{CE} = 5.0 \text{ Vdc}$ ,  $T_A = 25^\circ\text{C}$ )



**Figure 2. Noise Voltage**

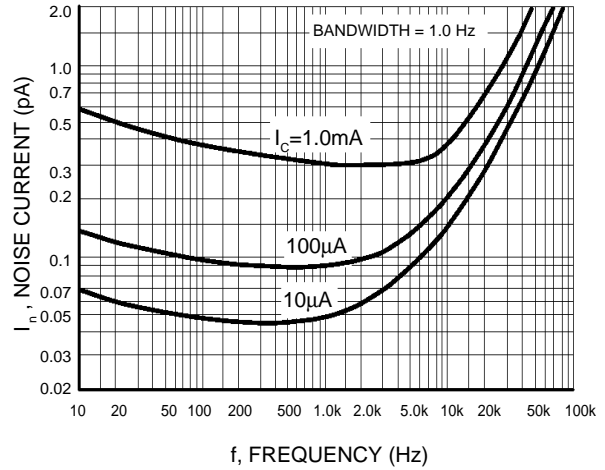

**Figure 3. Noise Current**

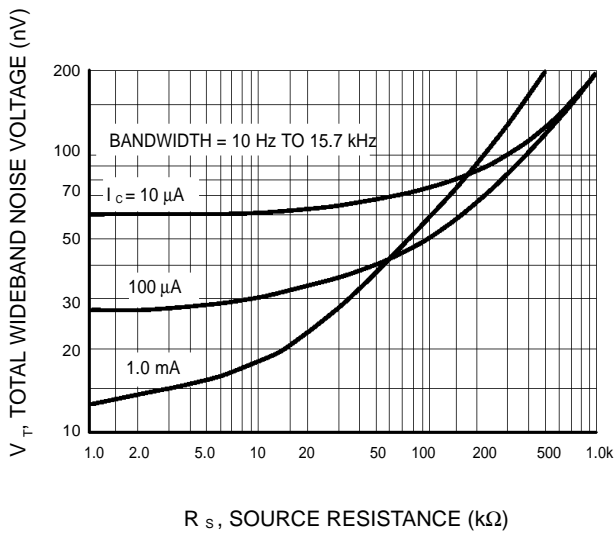

**Figure 4. Total Wideband Noise Voltage**

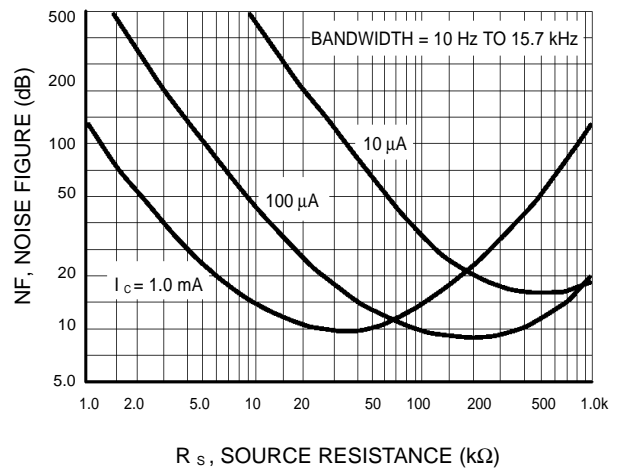

**Figure 5. Wideband Noise Figure**

**LMBTA13LT1 LMBTA14LT1**

**SMALL-SIGNAL CHARACTERISTICS**

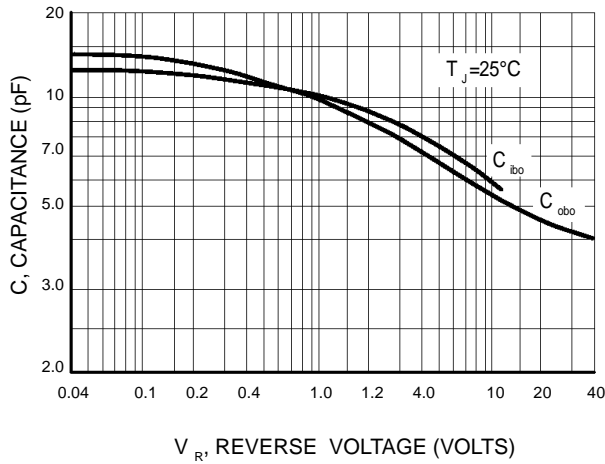

**Figure 6. Capacitance**

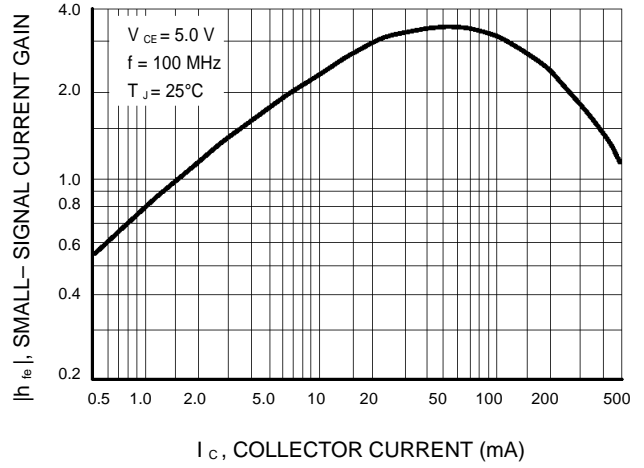

**Figure 7. High Frequency Current Gain**

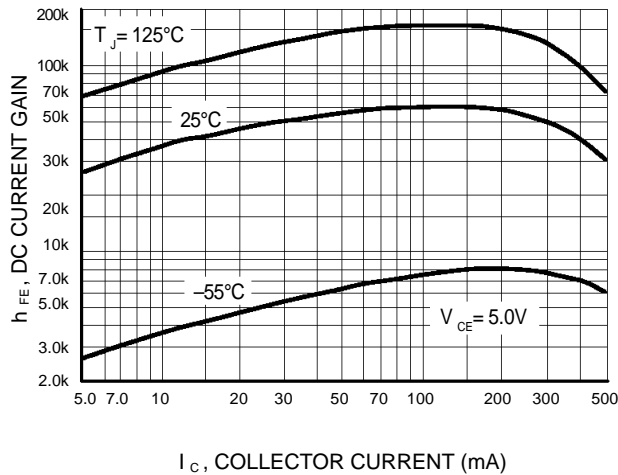

**Figure 8. DC Current Gain**

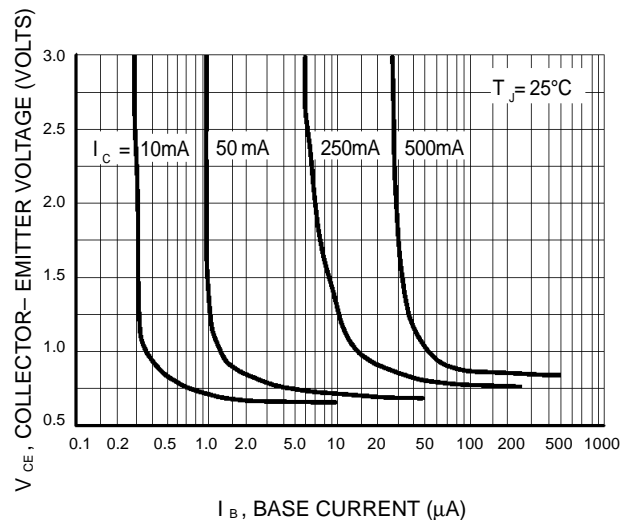

**Figure 9. Collector Saturation Region**

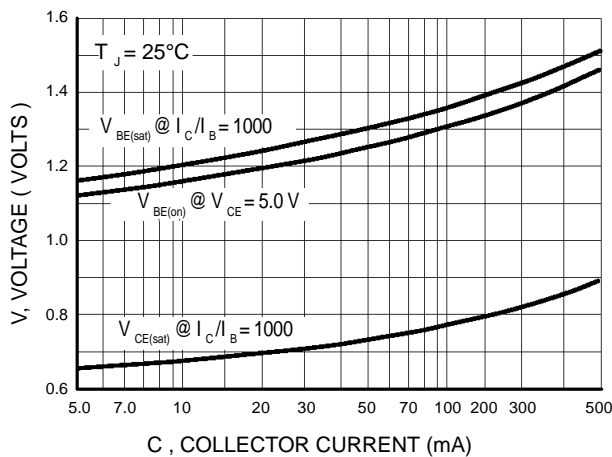

**Figure 17. "ON" Voltages**

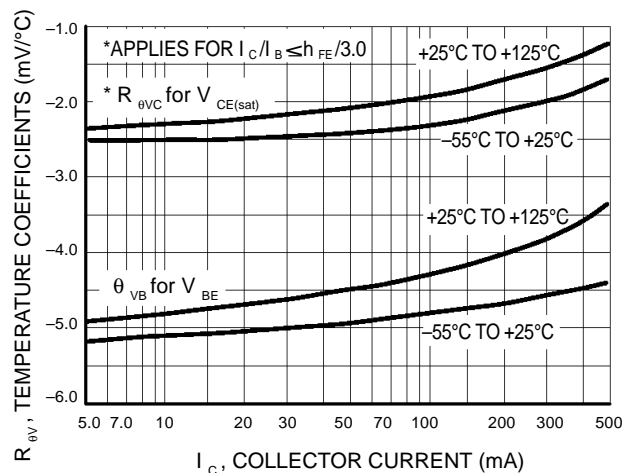

**Figure 18. Temperature Coefficients**

LMBTA13LT1 LMBTA14LT1

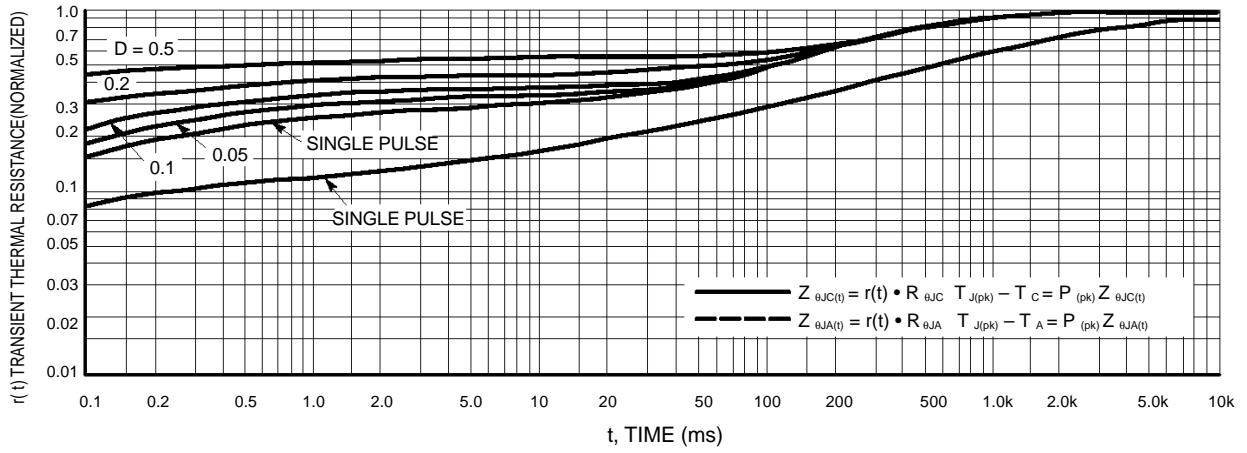

Figure 12. Thermal Response

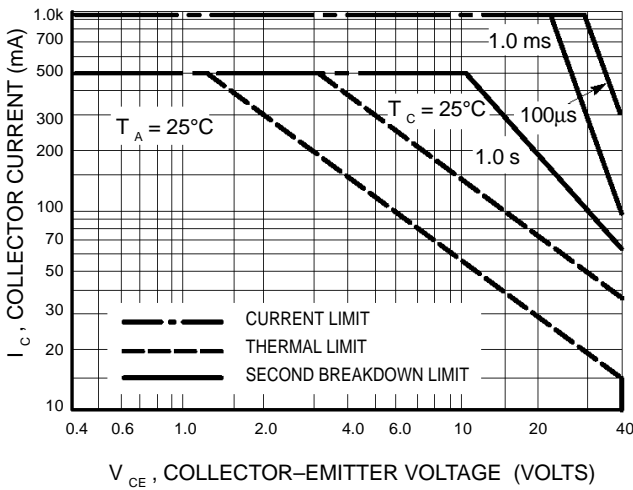
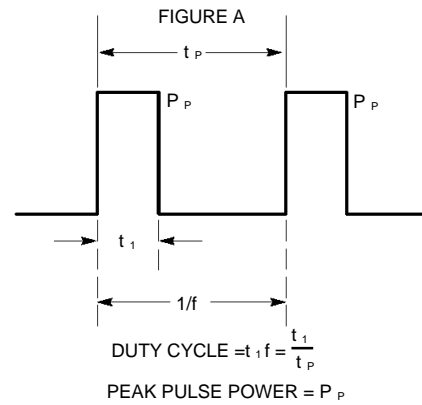

Figure 13. Active Region Safe Operating Area



Design Note: Use of Transient Thermal Resistance Data

LMBTA13LT1 LMBTA14LT1

SOT-23

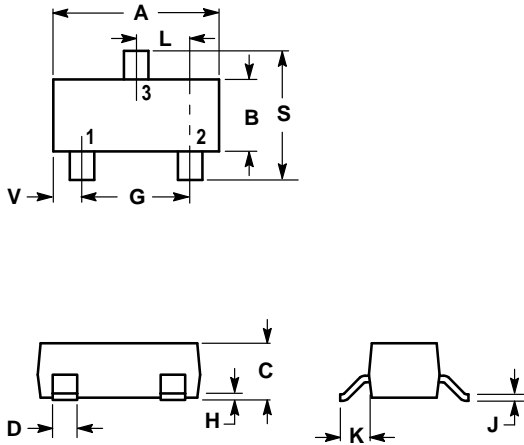

NOTES:

1. DIMENSIONING AND TOLERANCING PER ANSI Y14.5M, 1982.
2. CONTROLLING DIMENSION: INCH.

DIM	INCHES		MILLIMETERS	
	MIN	MAX	MIN	MAX
A	0.1102	0.1197	2.80	3.04
B	0.0472	0.0551	1.20	1.40
C	0.0350	0.0440	0.89	1.11
D	0.0150	0.0200	0.37	0.50
G	0.0701	0.0807	1.78	2.04
H	0.0005	0.0040	0.013	0.100
J	0.0034	0.0070	0.085	0.177
K	0.0140	0.0285	0.35	0.69
L	0.0350	0.0401	0.89	1.02
S	0.0830	0.1039	2.10	2.64
V	0.0177	0.0236	0.45	0.60

- PIN 1. BASE  
 2. EMITTER  
 3. COLLECTOR

