

## LMC6772

### Dual Micropower Rail-To-Rail Input CMOS Comparator with Open Drain Output

#### General Description

The LMC6772 is an ultra low power dual comparator with a maximum 10  $\mu$ A/comparator power supply current. It is designed to operate over a wide range of supply voltages, with a minimum supply voltage of 2.7V.

The common mode voltage range of the LMC6772 exceeds both the positive and negative supply rails, a significant advantage in single supply applications. The open drain output of the LMC6772 allows for wired-OR configurations. The open drain output also offers the advantage of allowing the output to be pulled to any voltage rail up to 15V, regardless of the supply voltage of the LMC6772.

The LMC6772 is targeted for systems where low power consumption is the critical parameter. Guaranteed operation at supply voltages of 2.7V and rail-to-rail performance makes this comparator ideal for battery-powered applications.

Refer to the LMC6762 datasheet for a push-pull output stage version of this device.

#### Features

(Typical unless otherwise noted)

- Low power consumption (max):  $I_S = 10 \mu\text{A}/\text{comp}$
- Wide range of supply voltages: 2.7V to 15V
- Rail-to-Rail Input Common Mode Voltage Range
- Open drain output
- Short circuit protection: 40 mA
- Propagation delay (@ $V_S = 5\text{V}$ , 100 mV overdrive): 5  $\mu\text{s}$

#### Applications

- Laptop computers
- Mobile phones
- Metering systems
- Hand-held electronics
- RC timers
- Alarm and monitoring circuits
- Window comparators, multivibrators

#### Connection Diagram

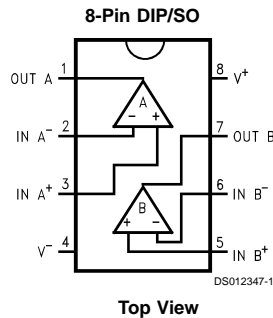

#### Ordering Information

Package	Temperature Range -40°C to +85°C	NSC Drawing	Transport Media
8-Pin Molded DIP	LMC6772AIN, LMC6772BIN	N08E	Rails
8-Pin Small Outline	LMC6772AIM, LMC6772BIM LMC6772AIMX, LMC6772BIMX	M08A M08A	Rails Tape and Reel

## Absolute Maximum Ratings (Note 1)

If Military/Aerospace specified devices are required, please contact the National Semiconductor Sales Office/Distributors for availability and specifications.

ESD Tolerance (Note 2)	1.5 kV
Differential Input Voltage	(V <sup>+</sup> )+0.3V to (V <sup>-</sup> )-0.3V
Voltage at Input/Output Pin	(V <sup>+</sup> )+0.3V to (V <sup>-</sup> )-0.3V
Supply Voltage (V <sup>+</sup> -V <sup>-</sup> )	16V
Current at Input Pin (Note 8)	±5 mA
Current at Output Pin (Notes 3, 7)	±30 mA
Current at Power Supply Pin, LMC6772	40 mA
Lead Temperature (Soldering, 10 seconds)	260°C

Storage Temperature Range	-65°C to +150°C
Junction Temperature (Note 4)	150°C

## Operating Ratings (Note 1)

Supply Voltage	2.7 ≤ V <sub>S</sub> ≤ 15V
Junction Temperature Range	40°C ≤ T <sub>J</sub> ≤ +85°C
LMC6772AI, LMC6772BI	
Thermal Resistance (θ <sub>JA</sub> )	
N Package, 8-Pin Molded DIP	100°C/W
M Package, 8-Pin Surface Mount	172°C/W

## 2.7V Electrical Characteristics

Unless otherwise specified, all limits guaranteed for T<sub>J</sub> = 25°C, V<sup>+</sup> = 2.7V, V<sup>-</sup> = 0V, V<sub>CM</sub> = V<sup>+</sup>/2. **Boldface** limits apply at the temperature extremes.

Symbol	Parameter	Conditions	Typ (Note 5)	LMC6772AI Limit (Note 6)	LMC6772BI Limit (Note 6)	Units
V <sub>OS</sub>	Input Offset Voltage		3	5	15	mV
			<b>8</b>	<b>18</b>	max	
TCV <sub>OS</sub>	Input Offset Voltage Temperature Drift		2.0			μV/°C
			Input Offset Voltage Average Drift	(Note 10)	3.3	
I <sub>B</sub>	Input Current		0.02			pA
I <sub>OS</sub>	Input Offset Current		0.01			pA
CMRR	Common Mode Rejection Ratio		75			dB
PSRR	Power Supply Rejection Ratio	±1.35V < V <sub>S</sub> < ±7.5V	80			dB
A <sub>V</sub>	Voltage Gain	(By Design)	100			dB
V <sub>CM</sub>	Input Common-Mode Voltage Range	CMRR > 55 dB	3.0	2.9	2.9	V
				<b>2.7</b>	<b>2.7</b>	min
			-0.3	-0.2	-0.2	V
				<b>0.0</b>	<b>0.0</b>	max
V <sub>OL</sub>	Output Voltage Low	I <sub>LOAD</sub> = 2.5 mA	0.2	0.3	0.3	V
				<b>0.4</b>	<b>0.4</b>	max
I <sub>S</sub>	Supply Current	For Both Comparators (Output Low)	12	20	20	μA
				<b>25</b>	<b>25</b>	max
I <sub>Leakage</sub>	Output Leakage Current	V <sub>IN(+)</sub> = 0.5V, V <sub>IN(-)</sub> = 0V, V <sub>O</sub> = 15V	0.1	500	500	nA

## 5.0V and 15.0V Electrical Characteristics

Unless otherwise specified, all limits guaranteed for T<sub>J</sub> = 25°C, V<sup>+</sup> = 5.0V and 15.0V, V<sup>-</sup> = 0V, V<sub>CM</sub> = V<sup>+</sup>/2. **Boldface** limits apply at the temperature extremes.

Symbol	Parameter	Conditions	Typ (Note 5)	LMC6772AI Limit (Note 6)	LMC6772BI Limit (Note 6)	Units
V <sub>OS</sub>	Input Offset Voltage		3	5	15	mV
			<b>8</b>	<b>18</b>	max	
TCV <sub>OS</sub>	Input Offset Voltage Temperature Drift	V <sup>+</sup> = 5V	2.0			μV/°C
		V <sup>+</sup> = 15V	4.0			
	Input Offset Voltage Average Drift	V <sup>+</sup> = 5V (Note 10)	3.3			μV/Month
		V <sup>+</sup> = 15V (Note 10)	4.0			

## 5.0V and 15.0V Electrical Characteristics (Continued)

Unless otherwise specified, all limits guaranteed for  $T_J = 25^\circ\text{C}$ ,  $V^+ = 5.0\text{V}$  and  $15.0\text{V}$ ,  $V^- = 0\text{V}$ ,  $V_{\text{CM}} = V^+/2$ . **Boldface** limits apply at the temperature extremes.

Symbol	Parameter	Conditions	Typ (Note 5)	LMC6772AI Limit (Note 6)	LMC6772BI Limit (Note 6)	Units
$I_B$	Input Current	$V = 5\text{V}$	0.04			pA
$I_{\text{OS}}$	Input Offset Current	$V^+ = 5\text{V}$	0.02			pA
CMRR	Common Mode Rejection Ratio	$V^+ = 5\text{V}$	75			dB
		$V^+ = 15\text{V}$	82			dB
PSRR	Power Supply Rejection Ratio	$\pm 2.5\text{V} < V_S < \pm 5\text{V}$	80			dB
$A_V$	Voltage Gain	(By Design)	100			dB
$V_{\text{CM}}$	Input Common-Mode Voltage Range	$V^+ = 5.0\text{V}$ CMRR > 55 dB	5.3	5.2	5.2	V
			-0.3	-0.2	-0.2	V
				<b>0.0</b>	<b>0.0</b>	max
		$V^+ = 15.0\text{V}$ CMRR > 55 dB	15.3	15.2	15.2	V
			-0.3	-0.2	-0.2	V
				<b>0.0</b>	<b>0.0</b>	max
$V_{\text{OL}}$	Output Voltage Low	$V^+ = 5\text{V}$ $I_{\text{LOAD}} = 5\text{ mA}$	0.2	0.4	0.4	V
				<b>0.55</b>	<b>0.55</b>	max
		$V^+ = 15\text{V}$ $I_{\text{LOAD}} = 5\text{ mA}$	0.2	0.4	0.4	V
			<b>0.55</b>	<b>0.55</b>	max	
$I_S$	Supply Current	For Both Comparators (Output Low)	12	20	20	$\mu\text{A}$
				<b>25</b>	<b>25</b>	max
$I_{\text{SC}}$	Short Circuit Current	$V^+ = 15\text{V}$ , Sinking, $V_O = 12\text{V}$ (Note 7)	45			mA

## AC Electrical Characteristics

Unless otherwise specified, all limits guaranteed for  $T_J = 25^\circ\text{C}$ ,  $V^+ = 5\text{V}$ ,  $V^- = 0\text{V}$ ,  $V_{\text{CM}} = V_O = V^+/2$ . **Boldface** limits apply at the temperature extreme.

Symbol	Parameter	Conditions	Typ (Note 5)	LMC6772AI Limit (Note 6)	LMC6772BI Limit (Note 6)	Units
$t_{\text{RISE}}$	Rise Time	$f = 10\text{ kHz}$ , $C_L = 50\text{ pF}$ , Overdrive = 10 mV (Note 9)	0.3			$\mu\text{s}$
$t_{\text{FALL}}$	Fall Time	$f = 10\text{ kHz}$ , $C_L = 50\text{ pF}$ , Overdrive = 10 mV (Note 9)	0.3			$\mu\text{s}$
$t_{\text{PHL}}$	Propagation Delay (High to Low)	$f = 10\text{ kHz}$ , $C_L = 50\text{ pF}$ (Note 9)	10 mV	10		$\mu\text{s}$
			100 mV	4		$\mu\text{s}$
		$V^+ = 2.7\text{V}$ , $f = 10\text{ kHz}$ , $C_L = 50\text{ pF}$ (Note 9)	10 mV	10		$\mu\text{s}$
			100 mV	4		$\mu\text{s}$

## AC Electrical Characteristics (Continued)

Unless otherwise specified, all limits guaranteed for  $T_J = 25^\circ\text{C}$ ,  $V^+ = 5\text{V}$ ,  $V^- = 0\text{V}$ ,  $V_{\text{CM}} = V_O = V^+/2$ . **Boldface** limits apply at the temperature extreme.

Symbol	Parameter	Conditions	Typ (Note 5)	LMC6772AI Limit (Note 6)	LMC6772BI Limit (Note 6)	Units
$t_{\text{PLH}}$	Propagation Delay (Low to High)	$f = 10\text{ kHz}$ , $C_L = 50\text{ pF}$ (Note 9)	10 mV	10		$\mu\text{s}$
			100 mV	4		$\mu\text{s}$
		$V^+ = 2.7\text{V}$ , $f = 10\text{ kHz}$ , $C_L = 50\text{ pF}$ (Note 9)	10 mV	8		$\mu\text{s}$
			100 mV	4		$\mu\text{s}$

**Note 1:** Absolute Maximum Ratings indicate limits beyond which damage to the device may occur. Operating Ratings indicate conditions for which the device is intended to be functional, but specific performance is not guaranteed. For guaranteed specifications and the test conditions, see the electrical characteristics.

**Note 2:** Human body model, 1.5 k $\Omega$  in series with 100 pF. The output pins of the two comparators (pin 1 and pin 7) have an ESD tolerance of 1.5 kV. All other pins have an ESD tolerance of 2 kV.

**Note 3:** Applies to both single-supply and split-supply operation. Continuous short circuit operation at elevated ambient temperature can result in exceeding the maximum allowed junction temperature of 150°C. Output currents in excess of  $\pm 30\text{ mA}$  over long term may adversely affect reliability.

**Note 4:** The maximum power dissipation is a function of  $T_{\text{J(max)}}$ ,  $\theta_{\text{JA}}$ , and  $T_{\text{A}}$ . The maximum allowable power dissipation at any ambient temperature is  $P_D = (T_{\text{J(max)}} - T_{\text{A}})/\theta_{\text{JA}}$ . All numbers apply for packages soldered directly into a PC board.

**Note 5:** Typical Values represent the most likely parametric norm.

**Note 6:** All limits are guaranteed by testing or statistical analysis.

**Note 7:** Do not short circuit output to  $V^+$ , when  $V^+$  is  $> 12\text{V}$  or reliability will be adversely affected.

**Note 8:** Limiting input pin current is only necessary for input voltages that exceed absolute maximum input voltage ratings.

**Note 9:**  $C_L$  includes the probe and jig capacitance. The rise time, fall time and propagation delays are measured with a 2V input step.

**Note 10:** Input offset voltage Average Drift is calculated by dividing the accelerated operating life drift average by the equivalent operational time. The input offset voltage average drift represents the input offset voltage change at worst-case input conditions.

## Typical Performance Characteristics $V^+ = 5\text{V}$ , Single Supply, $T_{\text{A}} = 25^\circ\text{C}$ unless otherwise specified

**Supply Current vs Supply Voltage (Output High)**

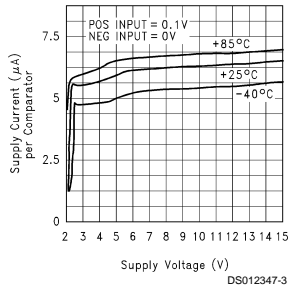

**Supply Current vs Supply Voltage (Output Low)**

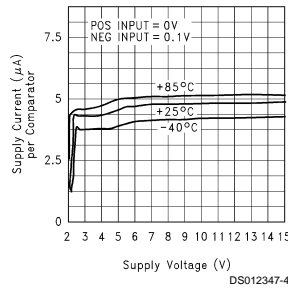

**Input Current vs Common-Mode Voltage**

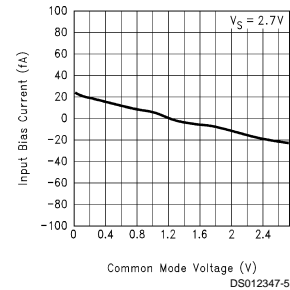

**Input Current vs Common-Mode Voltage**

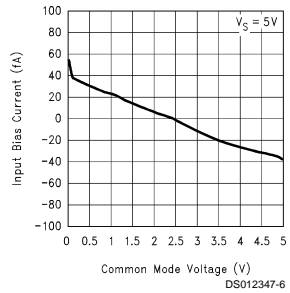

**Input Current vs Common-Mode Voltage**

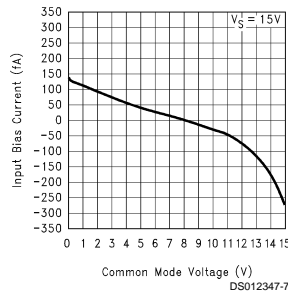

**Input Current vs Temperature**

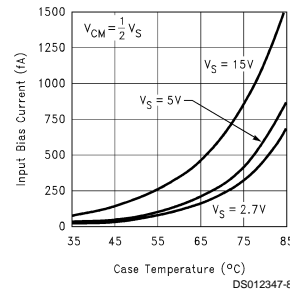

**Typical Performance Characteristics**  $V^+ = 5V$ , Single Supply,  $T_A = 25^\circ C$  unless otherwise specified (Continued)

**$\Delta V_{OS}$  vs  $\Delta V_{CM}$**   
 $V_S = 2.7V$

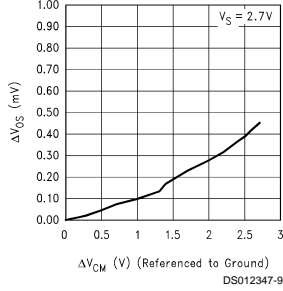

**$\Delta V_{OS}$  vs  $\Delta V_{CM}$**   
 $V_S = 5V$

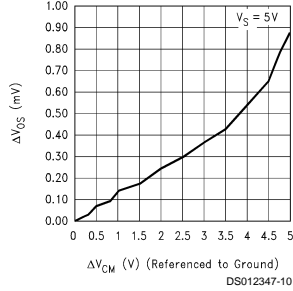

**$\Delta V_{OS}$  vs  $\Delta V_{CM}$**   
 $V_S = 15V$

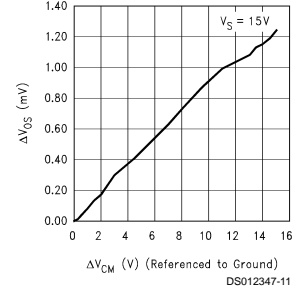

**Output Voltage vs Output Current (Sinking)**

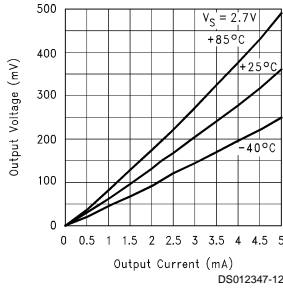

**Output Voltage vs Output Current (Sinking)**

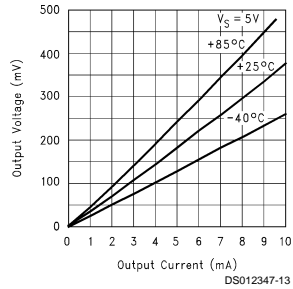

**Output Voltage vs Output Current (Sinking)**

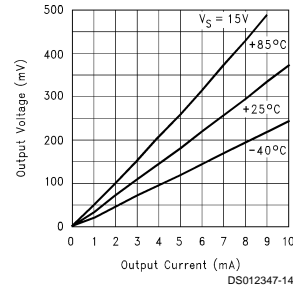

**Output Short Circuit Current (Sinking) vs Supply Voltage**

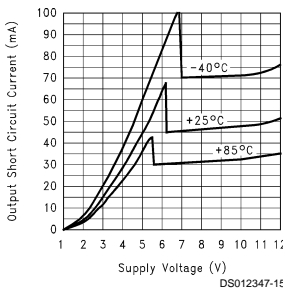

**Leakage Current vs Output Voltage**

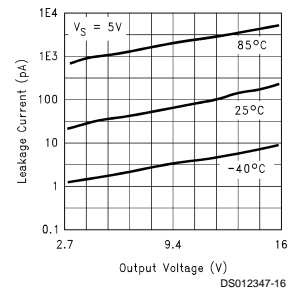

**Response Time for Overdrive ( $t_{PLH}$ )**

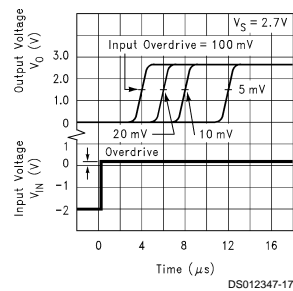

**Typical Performance Characteristics**  $V^+ = 5V$ , Single Supply,  $T_A = 25^\circ C$  unless otherwise specified (Continued)

**Response Time for Overdrive ( $t_{PHL}$ )**

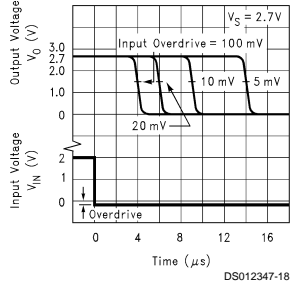

**Response Time for Overdrive ( $t_{PLH}$ )**

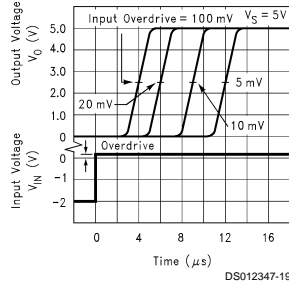

**Response Time for Overdrive ( $t_{PHL}$ )**

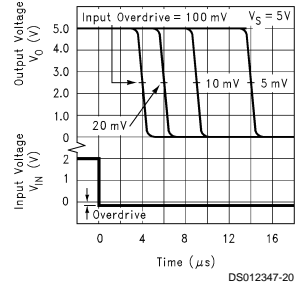

**Response Time for Overdrive ( $t_{PLH}$ )**

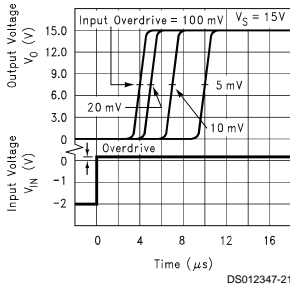

**Response Time for Overdrive ( $t_{PHL}$ )**

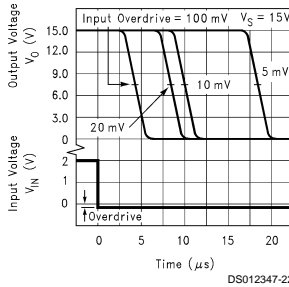

**Response Time vs Capacitive Load**

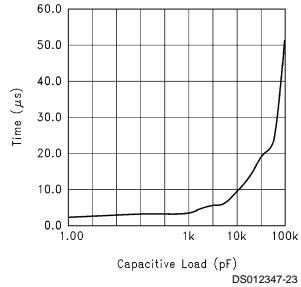

**Application Hints**

**1.0 Input Common-Mode Voltage Range**

At supply voltages of 2.7V, 5V and 15V, the LMC6772 has an input common-mode voltage range which exceeds both supplies. As in the case of operational amplifiers, CMVR is defined by the  $V_{OS}$  shift over the common-mode range of the device. A CMRR ( $\Delta V_{OS}/\Delta V_{CM}$ ) of 75 dB (typical) implies a shift of  $< 1$  mV over the entire common-mode range of the device. The absolute maximum input voltage at  $V^+ = 5V$  is 200 mV beyond either supply rail at room temperature.

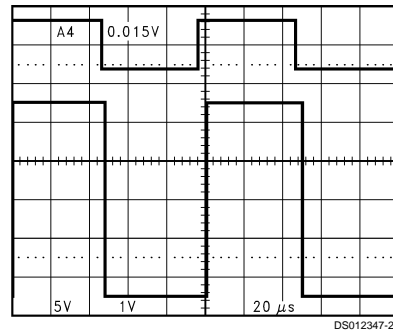

**FIGURE 1. An Input Signal Exceeds the LMC6772 Power Supply Voltages with No Output Phase Inversion**

A wide input voltage range means that the comparator can be used to sense signals close to ground and also to the power supplies. This is an extremely useful feature in power supply monitoring circuits.

An input common-mode voltage range that exceeds the supplies, 20 fA input currents (typical), and a high input impedance makes the LMC6772 ideal for sensor applications. The LMC6772 can directly interface to sensors without the use of amplifiers or bias circuits. In circuits with sensors which produce outputs in the tens to hundreds of millivolts, the

## 1.0 Input Common-Mode Voltage Range (Continued)

LMC6772 can compare the sensor signal with an appropriately small reference voltage. This reference voltage can be close to ground or the positive supply rail.

## 2.0 Low Voltage Operation

Comparators are the common devices by which analog signals interface with digital circuits. The LMC6772 has been designed to operate at supply voltages of 2.7V, without sacrificing performance, to meet the demands of 3V digital systems.

At supply voltages of 2.7V, the common-mode voltage range extends 200 mV (guaranteed) below the negative supply. This feature, in addition to the comparator being able to sense signals near the positive rail, is extremely useful in low voltage applications.

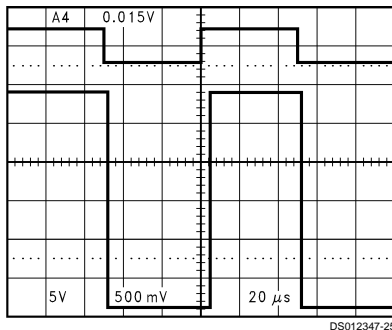

**FIGURE 2. Even at Low-Supply Voltage of 2.7V, an Input Signal which Exceeds the Supply Voltages Produces No Phase Inversion at the Output**

At  $V^+ = 2.7V$ , propagation delays are  $t_{PLH} = 4 \mu s$  and  $t_{PHL} = 4 \mu s$  with overdrives of 100 mV. Please refer to the performance curves for more extensive characterization.

## 3.0 Output Short Circuit Current

The LMC6772 has short circuit protection of 40 mA. However, it is not designed to withstand continuous short circuits, transient voltage or current spikes, or shorts to any voltage beyond the supplies. A resistor is series with the output should reduce the effect of shorts. For outputs which send signals off PC boards additional protection devices, such as diodes to the supply rails, and varistors may be used.

## 4.0 Hysteresis

If the input signal is very noisy, the comparator output might trip several times as the input signal repeatedly passes through the threshold. This problem can be addressed by making use of hysteresis as shown below.

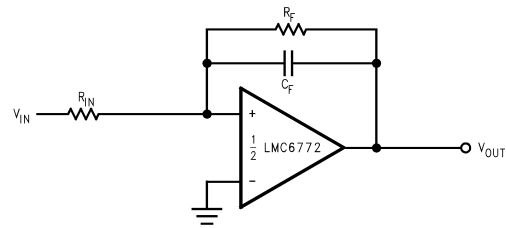

**FIGURE 3. Canceling the Effect of Input Capacitance**

The capacitor added across the feedback resistor increases the switching speed and provides more short term hysteresis. This can result in greater noise immunity for the circuit.

## 5.0 Spice Macromodel

A Spice Macromodel is available for the LMC6772. The model includes a simulation of:

- Input common-mode voltage range
- Quiescent and dynamic supply current
- Input overdrive characteristics

and many more characteristics as listed on the macromodel disk.

Contact the National Semiconductor Customer Response Center at 1-800-272-9959 to obtain an operational amplifier spice model library disk.

## Typical Applications

### Universal Logic Level Shifter

The output of the LMC6772 is the uncommitted drain of the output NMOS transistor. Many drains can be tied together to provide an output OR'ing function. An output pullup resistor can be connected to any available power supply voltage within the permitted power supply range.

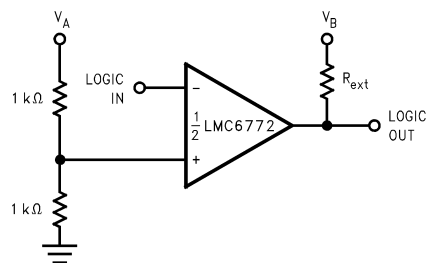

**FIGURE 4. Universal Logic Level Shifter**

The two 1 kΩ resistors bias the input to half of the power supply voltage. The pull-up resistor should go to the output logic supply. Due to its wide operating range, the LMC6772 is ideal for the logic level shifting applications.

## Typical Applications (Continued)

### One-Shot Multivibrator

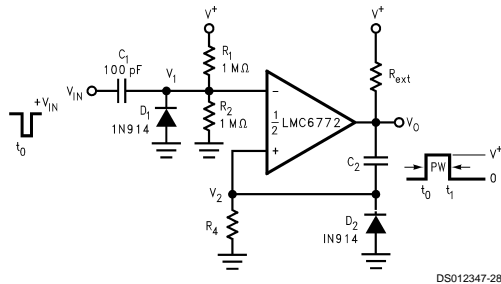

FIGURE 5. One-Shot Multivibrator

A monostable multivibrator has one stable state in which it can remain indefinitely. It can be triggered externally to another quasi-stable state. A monostable multivibrator can thus be used to generate a pulse of desired width.

The desired pulse width is set by adjusting the values of  $C_2$  and  $R_4$ . The resistor divider of  $R_1$  and  $R_2$  can be used to determine the magnitude of the input trigger pulse. The LMC6772 will change state when  $V_1 < V_2$ . Diode  $D_2$  provides a rapid discharge path for capacitor  $C_2$  to reset at the end of the pulse. The diode also prevents the non-inverting input from being driven below ground.

### Bi-Stable Multivibrator

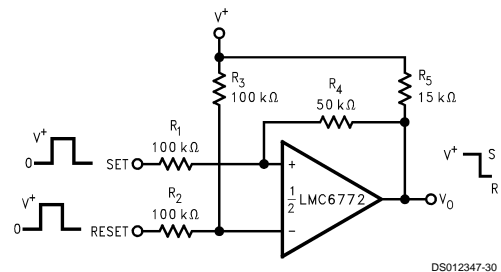

FIGURE 6. Bi-Stable Multivibrator

A bi-stable multivibrator has two stable states. The reference voltage is set up by the voltage divider of  $R_2$  and  $R_3$ . A pulse applied to the SET terminal will switch the output of the comparator high. The resistor divider of  $R_1$ ,  $R_4$ , and  $R_5$  now clamps the non-inverting input to a voltage greater than the reference voltage. A pulse applied to RESET will now toggle the output low.

### Zero Crossing Detector

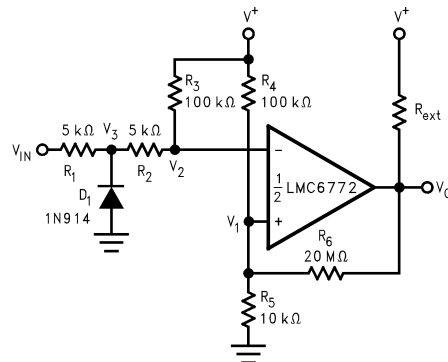

FIGURE 7. Zero Crossing Detector

A voltage divider of  $R_4$  and  $R_5$  establishes a reference voltage  $V_1$  at the non-inverting input. By making the series resistance of  $R_1$  and  $R_2$  equal to  $R_5$ , the comparator will switch when  $V_{IN} = 0$ . Diode  $D_1$  insures that  $V_3$  never drops below  $-0.7V$ . The voltage divider of  $R_2$  and  $R_3$  then prevents  $V_2$  from going below ground. A small amount of hysteresis is setup to ensure rapid output voltage transitions.

### Oscillator

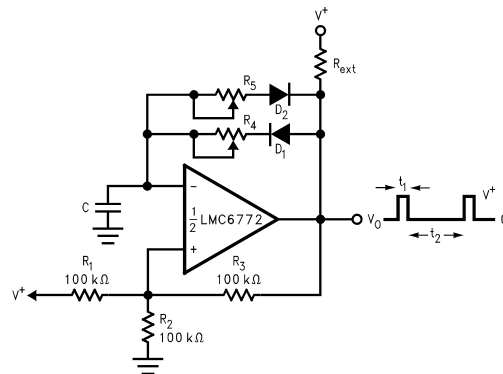
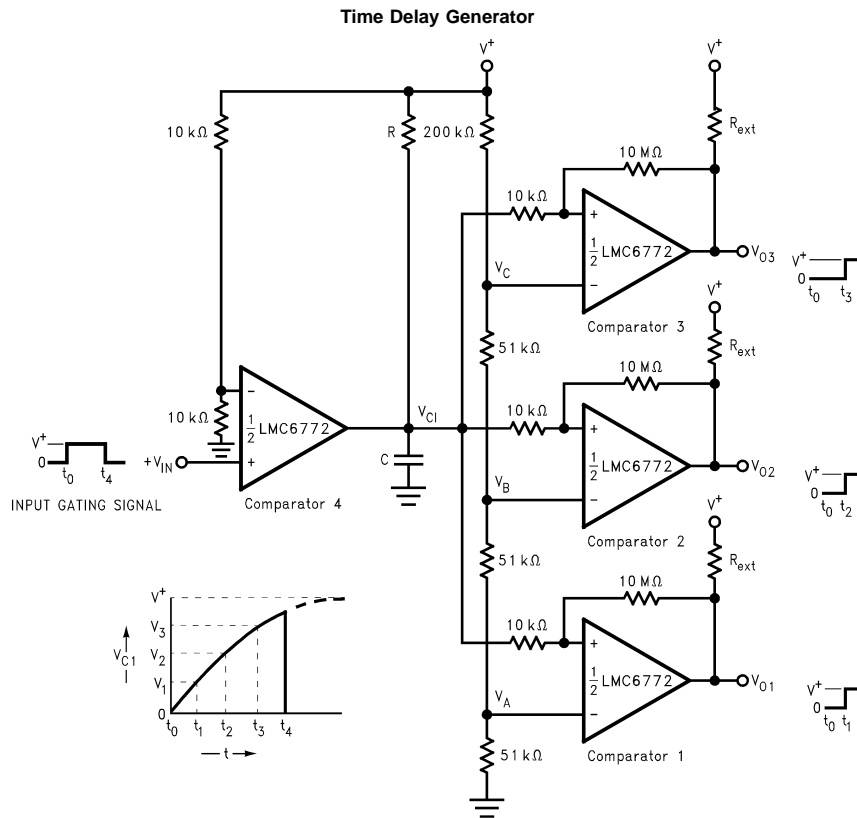

FIGURE 8. Square Wave Generator

Figure 8 shows the application of the LMC6772 in a square wave generator circuit. The total hysteresis of the loop is set by  $R_1$ ,  $R_2$  and  $R_3$ .  $R_4$  and  $R_5$  provide separate charge and discharge paths for the capacitor  $C$ . The charge path is set through  $R_4$  and  $D_1$ . So, the pulse width  $t_1$  is determined by the RC time constant of  $R_4$  and  $C$ . Similarly, the discharge path for the capacitor is set by  $R_5$  and  $D_2$ . Thus, the time  $t_2$  between the pulses can be changed by varying  $R_5$ , and the pulse width can be altered by  $R_4$ . The frequency of the output can be changed by varying both  $R_4$  and  $R_5$ .



## Typical Applications (Continued)



DS012347-32

**FIGURE 9. Time Delay Generator**

The circuit shown above provides output signals at a prescribed time interval from a time reference and automatically resets the output when the input returns to ground. Consider the case of  $V_{IN} = 0$ . The output of comparator 4 is also at ground. This implies that the outputs of comparators 1, 2, and 3 are also at ground. When an input signal is applied, the output of comparator 4 swings high and C charges expo-

entially through R. This is indicated above. The output voltages of comparators 1, 2, and 3 switch to the high state when  $V_{C1}$  rises above the reference voltages  $V_A$ ,  $V_B$  and  $V_C$ . A small amount of hysteresis has been provided to insure fast switching when the RC time constant is chosen to give long delay times.

**Physical Dimensions** inches (millimeters) unless otherwise noted

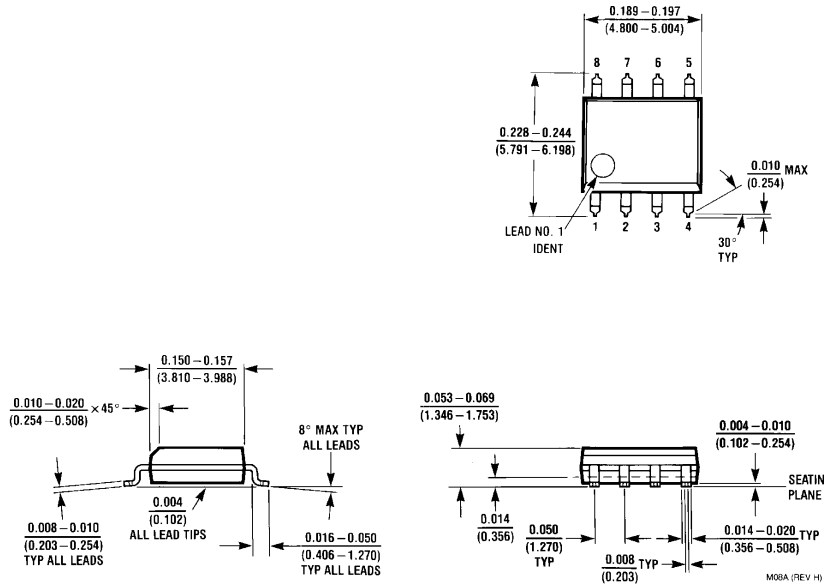

**8-Pin Small Outline Package**  
**Order Number LMC6772AI or LMC6772BI**  
**NS Package Number M08A**

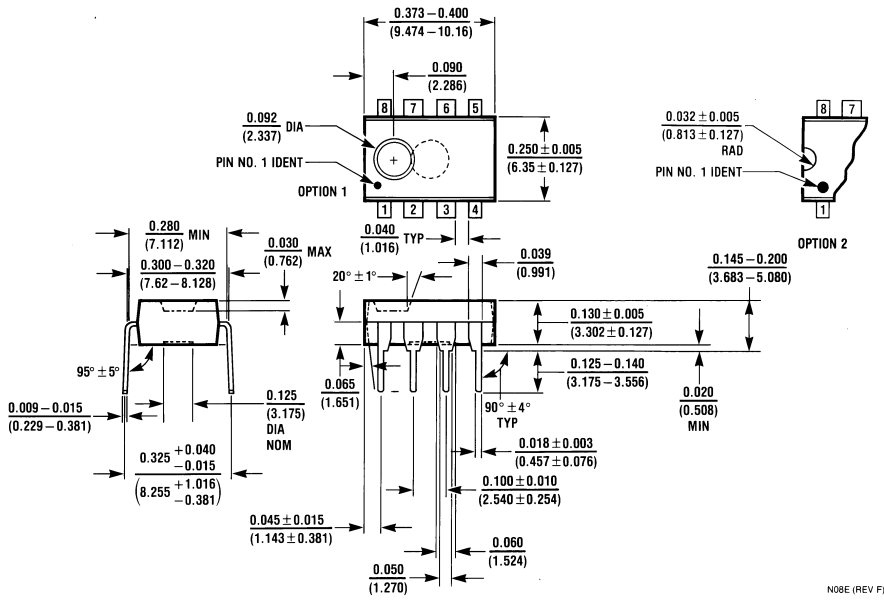

**8-Pin Molded Dual-In-Line Package**  
**Order Number LMC6772AI or LMC6772BI**  
**NS Package Number N08E**

## Notes

### LIFE SUPPORT POLICY

NATIONAL'S PRODUCTS ARE NOT AUTHORIZED FOR USE AS CRITICAL COMPONENTS IN LIFE SUPPORT DEVICES OR SYSTEMS WITHOUT THE EXPRESS WRITTEN APPROVAL OF THE PRESIDENT OF NATIONAL SEMICONDUCTOR CORPORATION. As used herein:

1. Life support devices or systems are devices or systems which, (a) are intended for surgical implant into the body, or (b) support or sustain life, and whose failure to perform when properly used in accordance with instructions for use provided in the labeling, can be reasonably expected to result in a significant injury to the user.
2. A critical component is any component of a life support device or system whose failure to perform can be reasonably expected to cause the failure of the life support device or system, or to affect its safety or effectiveness.



**National Semiconductor Corporation**  
Americas  
Tel: 1-800-272-9959  
Fax: 1-800-737-7018  
Email: support@nsc.com

[www.national.com](http://www.national.com)

**National Semiconductor Europe**  
Fax: +49 (0) 1 80-530 85 86  
Email: europe.support@nsc.com  
Deutsch Tel: +49 (0) 1 80-530 85 85  
English Tel: +49 (0) 1 80-532 78 32  
Français Tel: +49 (0) 1 80-532 93 58  
Italiano Tel: +49 (0) 1 80-534 16 80

**National Semiconductor Asia Pacific Customer Response Group**  
Tel: 65-2544466  
Fax: 65-2504466  
Email: sea.support@nsc.com

**National Semiconductor Japan Ltd.**  
Tel: 81-3-5639-7560  
Fax: 81-3-5639-7507