

# Panasonic

## Surface Mount LEDs

The chip LEDs have thin, compact features available for surface mount technology. It makes super brightness, has a wide viewing angle and is suitable for compact and multi-function equipment.

**Features:** • Compact and thin package • Super bright and high reliability • Surface mount technology available • Wide product range **Cleaning:** • Avoid using organic solvents. The surface of the LED may change when organic solvents such as trichloroethylene and acetone come in contact with the surface of the LED.

Fig. 1 — 0402 (1005) Leadless

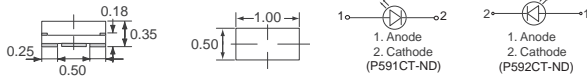

Fig. 2 — 0603 (1608) Leadless-SS Type

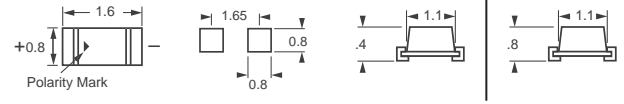

Fig. 3 — 0603 (1608) Leadless-TSS Type

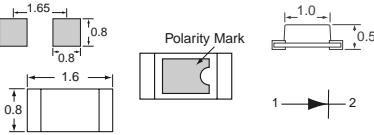

Fig. 4 — J-Lead-S Type

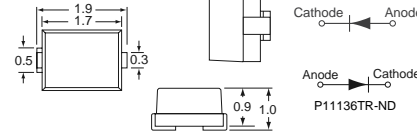

Fig. 5 — Gull Wing-S Type

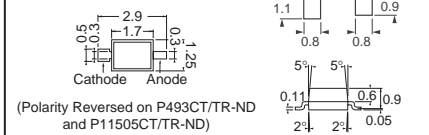
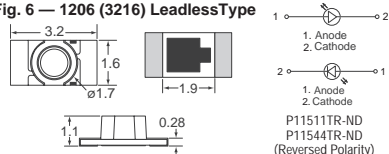
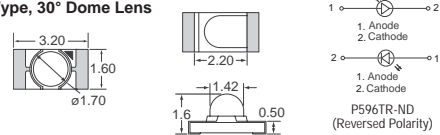

Fig.	Lighting Color	Lens	Process Tech.	Absolute Max. Ratings			I <sub>o</sub>		Rated (mA) IF	VF (V)		XP Typ.	Digi-Key Part No.	Cut Tape Price Each			Digi-Key Part No.	Tape & Reel		Panasonic Part No.	
				(mW) PD	(mA) IF	(°C) VR	(mcd) Typ.	(mcd) Min.		Typ.	Max.			1	10	100		Size	Pricing		
<b>0402 (1005) Leadless</b>																					
1	Yellow Green	Y/G Diffused	GaP	40	15	4	-30-85	3.7	2	10	2.03	2.6	565	P591CT-ND	.41	.38	.35	—	—	—	LNJ1939TARA
	High Bright Red	Red Diffused	GaAlAs	40	15	3	-30-85	4.2	2.2	10	1.72	2.5	655	P592CT-ND	.41	.38	.35	—	—	—	LNJ219R9ARA
<b>0603 (1608) Leadless Height=0.4mm</b>																					
2A	High Bright Red	Red Diffused	GaAlAs	40	15	3	-30-85	6.7	2.2	10	1.72	2.5	655	P11461CT-ND	.21	.19	.17	P11461TR-ND	5,000	62.24/M	LNJ214R8ARA
	Orange	Red Diffused	GaAsP	40	15	3	-30-85	1	0.5	10	1.93	2.6	630	P11462CT-ND	.19	.18	.16	P11462TR-ND	5,000	57.29/M	LNJ814R8DRA
	Soft Orange	Yellow Diffused	GaAsP	40	15	3	-30-85	1.5	0.6	10	1.93	2.6	630	P11463CT-ND	.19	.18	.16	P11463TR-ND	5,000	57.29/M	LNJ814K8SRA
	Amber	Yellow Diffused	GaAsP	40	15	3	-30-85	1.5	0.6	10	1.93	2.6	630	P11464CT-ND	.19	.18	.16	P11464TR-ND	5,000	57.29/M	LNJ141K8YRA
Yellow Green	Green Diffused	GaP	40	15	4	-30-85	5	1.8	10	2.03	2.6	565	P11465CT-ND	.18	.16	.15	P11465TR-ND	5,000	52.33/M	LNJ314G8TRA	
<b>Ultra Bright InGaAlP LED</b>																					
2A	Ultra Bright Red	Red Diffused	InGaAlP	40	15	4	-30-85	15	8	10	1.92	2.5	645	P11466CT-ND	.31	.29	.27	P11466TR-ND	5,000	114.57/M	LNJ214R82RA
	Orange	Red Diffused	InGaAlP	40	15	4	-30-85	30	16	10	1.93	2.5	620	P11467CT-ND	.31	.29	.27	P11467TR-ND	5,000	114.57/M	LNJ814R83RA
	Soft Orange	Yellow Diffused	InGaAlP	40	15	4	-30-85	21	8.7	10	1.95	2.5	615	P11469CT-ND	.31	.29	.27	P11469TR-ND	5,000	114.57/M	LNJ814R88RA
	Amber	Yellow Diffused	InGaAlP	40	15	4	-30-85	26	14	10	2.1	2.5	595	P11470CT-ND	.31	.29	.27	P11470TR-ND	5,000	114.57/M	LNJ814K87RA
Yellow Green	Green Diffused	InGaAlP	40	15	4	-30-85	12	6.4	10	2.03	2.5	575	P11471CT-ND	.31	.29	.27	P11471TR-ND	5,000	114.57/M	LNJ141K84RA	
<b>0603 (1608) Leadless Height=0.55mm</b>																					
3	High Bright Red	Red Diffused	GaAlAs	50	20	3	-30-85	6.7	2.2	10	1.72	2.5	655	P11133CT-ND	.18	.17	.16	P11133TR-ND	5,000	57.29/M	LNJ212R8ARA
	Orange	Orange Diffused	GaAsP	50	20	3	-30-85	1	0.4	10	1.93	2.6	630	P11594CT-ND	.18	.16	.15	P11594TR-ND	5,000	52.33/M	LNJ812R8DRA
	Soft Orange	Yellow Diffused	GaAsP	50	20	3	-30-85	1	0.5	10	1.93	2.6	610	P11472CT-ND	.18	.16	.15	P11472TR-ND	5,000	52.33/M	LNJ812K8SRA
	Amber	Yellow Diffused	GaAsP	50	20	4	-30-85	1.5	0.6	5	2	2.6	590	P11135CT-ND	.18	.17	.16	P11135TR-ND	5,000	52.33/M	LNJ141K8YRA
	Yellow Green	Green Diffused	GaP	50	20	4	-30-85	5	1.8	5	2.03	2.6	565	P11134CT-ND	.18	.17	.16	P11134TR-ND	5,000	47.37/M	LNJ312G8TRA
Yellow Green	Green Diffused	GaP	30	10	4	-30-85	3	1.8	10	1.9	2.4	565	P11473CT-ND	.16	.15	.13	P11473TR-ND	5,000	47.37/M	LNJ121G8LRA	
<b>Ultra Bright InGaAlP / GaN LED</b>																					
3	Red	Red Diffused	InGaAlP	55	20	4	-30-85	15	8	10	1.92	2.5	645	P11475CT-ND	.29	.27	.24	P11475TR-ND	5,000	104.66/M	LNJ212R82RA
	Orange	Red Diffused	InGaAlP	55	20	4	-30-85	32	17	10	2.03	2.5	630	P11476CT-ND	.29	.27	.24	P11476TR-ND	5,000	104.66/M	LNJ812R83RA
	Orange	Red Diffused	InGaAlP	55	20	4	-30-85	30	16	10	1.95	2.5	620	P11477CT-ND	.29	.27	.24	P11477TR-ND	5,000	104.66/M	LNJ812R88RA
	Soft Orange	Yellow Diffused	InGaAlP	55	20	4	-30-85	21	7	10	1.95	2.5	615	P11478CT-ND	.29	.27	.24	P11478TR-ND	5,000	104.66/M	LNJ812K87RA
	Amber	Yellow Diffused	InGaAlP	55	20	4	-30-85	26	14	10	2.1	2.5	595	P11479CT-ND	.29	.27	.24	P11479TR-ND	5,000	104.66/M	LNJ141K84RA
	Yellow Green	Green Diffused	InGaAlP	55	20	4	-30-85	12	6.4	20	2.03	2.5	575	P11480CT-ND	.29	.27	.24	P11480TR-ND	5,000	104.66/M	LNJ312G83RA
	Pure Green	White Diffused	GaN	40	10	5	-25-85	14	10	3	3.7	5.25	3.7	525	P11481CT-ND	2.29	2.15	2.01	P11481TR-ND	5,000	949.58/M
Blue	White Diffused	GaN	40	10	5	-25-85	8.5	3.2	5	3.2	3.7	470	P11482CT-ND	2.29	2.15	2.01	P11482TR-ND	2,000	949.58/M	LNJ912W88RA	
White	White Diffused	GaN	40	10	5	-30-85	7.6	4.7	10	3.2	3.7	—	P12023CT-ND	2.70	2.53	2.29	P12023TR-ND	5,000	996.40/M	LNJ212K8BRA	
<b>0603 (1608) Leadless Height=0.8mm</b>																					
2B	High Bright Red	Red Diffused	GaAlAs	50	20	3	-30-85	6.7	2.2	10	1.72	2.5	660	P524CT-ND	.18	.17	.16	P524TR-ND	4,000	62.79/M	LNJ208R8ARA
	Orange	Orange Diffused	GaAsP	30	10	3	-30-85	1.1	0.4	5	1.8	2.4	630	P523CT-ND*	.18	.17	.16	P523TR-ND*	4,000	57.29/M	LNJ808R8ERA
	Soft Orange	Yellow Diffused	GaAsP	50	20	3	-30-85	1	0.4	10	1.93	2.6	610	P11132CT-ND	.18	.17	.16	P11132TR-ND	4,000	57.29/M	LNJ808K8SRA
	Amber	Yellow Diffused	GaAsP	50	20	4	-30-85	1.5	0.6	10	2	2.6	590	P11129CT-ND	.18	.17	.16	P11129TR-ND	4,000	57.29/M	LNJ408K8YRA
	Amber	Yellow Diffused	GaAsP	30	10	4	-30-85	0.9	0.4	5	1.9	2.4	590	P522CT-ND*	.18	.17	.16	P522TR-ND*	4,000	57.29/M	LNJ408K82RA
	Yellow Green	Green Diffused	GaP	50	20	4	-30-85	5	1.8	10	2.03	2.6	565	P525CT-ND	.18	.17	.16	P525TR-ND	4,000	52.33/M	LNJ308G8TRA
	Yellow Green	Green Diffused	GaP	30	10	4	-30-85	2.1	0.7	5	1.9	2.4	565	P521CT-ND*	.18	.17	.16	P521TR-ND*	4,000	52.33/M	LNJ308G8LRA
	Green	Green Diffused	GaP	60	20	4	-25-85	2.1	1.1	10	2.1	2.6	560	P11484CT-ND	.16	.15	.13	P11484TR-ND	4,000	62.79/M	LNJ308G84RA
	Pure Green	Green Diffused	GaP	50	20	4	-25-85	0.7	0.25	10	2.03	2.6	555	P11485CT-ND	.19	.18	.16	P11485TR-ND	4,000	62.79/M	LNJ308G8PRA
	<b>Ultra Bright InGaAlP LED</b>																				
2B	Ultra Bright Red	Red Diffused	InGaAlP	55	20	4	-25-85	15	8	10	1.92	2.5	645	P11486CT-ND	.29	.27	.24	P11486TR-ND	4,000	115.12/M	LNJ208R82RA
	Orange	Red Diffused	InGaAlP	55	20	4	-25-85	32	17	10	2.03	2.5	630	P11487CT-ND	.29	.27	.24	P11487TR-ND	4,000	115.12/M	LNJ808R83RA
	Orange	Red Diffused	InGaAlP	50	20	4	-25-85	6.5	2.5	10	1.9	2.3	620	P11131CT-ND	.29	.27	.25	P11131TR-ND	4,000	115.12/M	LNJ808R88RA
	Soft Orange	Yellow Diffused	InGaAlP	55	20	4	-25-85	21	7	10	1.95	2.5	615	P11488CT-ND	.29	.27	.24	P11488TR-ND	4,000	115.12/M	LNJ808K87RA
	Amber	Yellow Diffused	InGaAlP	50	20	4	-25-85	10.5	4	10	2	2.3	595	P11130CT-ND	.29	.27	.25	P11130TR-ND	4,000	115.12/M	LNJ408K84RA
Yellow Green	Green Diffused	InGaAlP	55	20	4	-25-85	12	6.4	10	2.03	2.5	575	P11489CT-ND	.29	.27	.24	P11489TR-ND	4,000	115.12/M	LNJ308G83RA	
<b>0805 (2012) J-Lead S-J Type 2mm pitch Taping</b>																					
4	Red	Red Diffused	GaP	60	20	4	-25-85	0.4	0.15	10	2.03	2.6	700	P11490CT-ND	.18	.17	.15	P11490TR-ND	6,000	54.53/M	LNJ206R5RXX
	High Bright Red	Red Diffused	GaAlAs	60	20	3	-25-85	5	1.7	10	1.72	2.5	660	P11136CT-ND	.18	.17	.16	P11136TR-ND	6,000	62.24/M	LNJ206R5ARA
	Soft Orange	Yellow Diffused	GaAsP	60	20	3	-25-85	0.8	0.3	10	1.93	2.6	610	P11491CT-ND	.19	.18	.16	P11491TR-ND	6,000	57.29/M	LNJ806K5SXX
	Amber	Yellow Diffused	GaAsP	60	20	4	-25-85	1	0.4	10	2	2.6	590	P11492CT-ND	.19	.18	.16	P11492TR-ND	6,000	57.29/M	LNJ406K5YXX
	Yellow Green	Green Diffused	GaP	60	20	4	-25-85	2.6	0.9	10	2.03	2.6	565	P11137CT-ND	.18	.17	.16	P11137TR-ND	6,000	54.53/M	LNJ306G5URA
Pure Green	Green Diffused	GaP	60	20	4	-25-85	0.65	0.25	10	2.03	2.6	555	P11493CT-ND	.21	.19	.17	P11493TR-ND	6,000	62.24/M	LNJ306G5PRX	
<b>Ultra Bright InGaAlP LED</b>																					
4	Orange	Red Diffused	InGaAlP	50	20	4	-25-85	8.5	2	10	1.9	2.3	620	P11494CT-ND	.31	.29	.27	P11494TR-ND	6,000	114.57/M	LNJ806R5BRX
	Amber	Yellow Diffused	InGaAlP	50	20	4	-25-85	8.5	3.5	10	2	2.3	595	P11495CT-ND	.31	.29	.27	P11495TR-ND	6,000	114.57/M	LNJ406K54RX
<b>0805 (2012) J-Lead S-J Type 4mm pitch Taping</b>																					
4	Red	Red Diffused	GaP	60	20	4	-25-85	0.4	0.15	10	2.03</										

**Fig. 6 — 1206 (3216) Leadless Type**



**Fig. 7 — 1206 (3216) Leadless Type, 30° Dome Lens**



**Fig. 8 — Leadless-Side View**

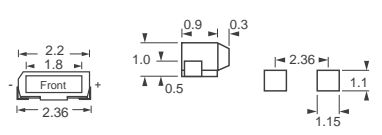

**Fig. 9 — Gull Wing-GW Type**

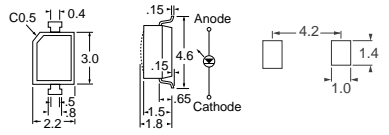

**Fig. 10 — J-Lead-S Type**

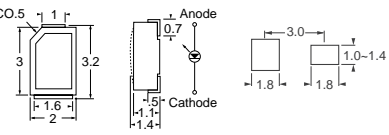

**Fig. 11 — TSS Bi-Color Type**

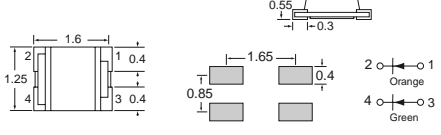

Fig.	Lighting Color	Lens	Process Tech.	Absolute Max. Ratings				I <sub>o</sub>		Rated IF	VF (V)		XP Type	Digi-Key Part No.	Cut Tape Price Each		Digi-Key Part No.	Tape & Reel		Panasonic Part No.	
				(mW) PD	(mA) IF	(V) VR	(°C) Topr	(mcd) Typ	(mcd) Min.		Typ.	Max.			1	100		Size	Pricing		
<b>0805 (2012) Gull Wing S-GW Type 2mm pitch Taping</b>																					
5	Soft Orange	Yellow Diffused	GaAsP	60	20	3	-25-85	0.8	0.3	10	1.93	2.6	610	P492CT-ND	—	.17	.16	P492TR-ND	6,000	57.29/M	LN1871Y5TR
	Amber	Yellow Diffused	GaAsP	60	20	4	-25-85	1	0.4	10	2	2.6	590	P11125CT-ND	.20	.18	.17	P11125TR-ND	6,000	57.29/M	LN1471Y1TR
	Amber	Yellow Diffused	GaAsP	30	10	4	-30-85	1	0.4	5	1.9	2.4	590	P517TR-ND*	.18	.17	.16	P517TR-ND*	6,000	65.55/M	LN1471S1YTR
	Yellow Green	Green Diffused	GaP	60	20	4	-25-85	2.6	0.9	10	2.03	2.6	565	P491CT-ND	—	.17	.16	P491TR-ND	6,000	54.53/M	LN1317G1TR
	Yellow Green	Green Diffused	GaP	30	10	4	-30-85	2	0.7	5	1.9	2.4	565	P516CT-ND*	.18	.17	.16	P516TR-ND*	6,000	62.24/M	LN1317S1GTR
	High Bright Yellow Green	Green Diffused	GaP	60	20	4	-25-85	5	3	10	2.03	2.6	565	P494CT-ND	—	.18	.17	P494TR-ND	6,000	56.74/M	LN13065TR02
<b>0805 (2012) Gull Wing S-GW Type 4mm pitch Taping</b>																					
5	Ultra Bright Red	Red Diffused	GaAlAs	60	20	3	-25-85	5	1.7	10	1.72	2.5	660	P11505CT-ND	.21	.19	.17	P11505TR-ND	3,000	68.30/M	LN1271RALTRP
	Orange	Red Diffused	GaAsP	60	20	3	-30-85	1	0.4	5	1.8	2.4	630	P11506CT-ND	.20	.18	.17	P11506TR-ND	3,000	65.55/M	LN1871S1TRP
	Soft Orange	Yellow Diffused	GaAsP	60	20	3	-30-85	0.8	0.3	10	1.93	2.6	610	P11507CT-ND	.19	.18	.16	P11507TR-ND	3,000	62.79/M	LN1871Y5TRP
	Amber	Yellow Diffused	GaAsP	30	10	4	-30-85	1	0.4	5	1.9	2.4	590	P11508CT-ND	.19	.18	.16	P11508TR-ND	3,000	62.79/M	LN1471S1YTRP
	Yellow Green	Green Diffused	GaP	60	20	4	-25-85	2.6	0.9	10	2.03	2.6	565	P11509CT-ND	.18	.17	.15	P11509TR-ND	3,000	59.49/M	LN1317G1TRP
	High Bright Yellow Green	Green Diffused	GaP	30	10	4	-25-85	2	0.7	5	1.9	2.4	565	P11510CT-ND	.19	.18	.16	P11510TR-ND	3,000	62.24/M	LN1317S1GTRP
	High Bright Yellow Green	Green Diffused	GaP	60	20	4	-25-85	5	3	10	2.03	2.6	565	P11595CT-ND	.19	.18	.16	P11595TR-ND	3,000	62.24/M	LN13065TUW0
<b>1206 (3216) Leadless with Flat Lens Type</b>																					
6	High Bright Red	Red Diffused	GaAlAs	60	20	3	-30-85	7	2.3	10	1.72	2.5	660	P11141CT-ND	.18	.17	.16	P11141TR-ND	3,000	76.01/M	LNJ211R8ARA
	Orange	Red Diffused	GaAsP	60	20	3	-30-85	1.8	0.7	10	1.93	2.6	630	P11526CT-ND	.21	.20	.18	P11526TR-ND	3,000	70.51/M	LNJ811R8DRA
	Soft Orange	Yellow Diffused	GaAsP	60	20	3	-30-85	1	0.5	10	1.93	2.6	610	P11527CT-ND	.21	.20	.18	P11527TR-ND	3,000	70.51/M	LNJ811K8SRA
	Amber	Yellow Diffused	GaAsP	60	20	4	-30-85	2.2	0.75	10	2	2.6	590	P11528CT-ND	.21	.20	.18	P11528TR-ND	3,000	70.51/M	LNJ411K8YRA
	Yellow Green	Green Diffused	GaP	60	20	4	-30-85	5.5	1.8	10	2.03	2.6	565	P11529CT-ND	.20	.18	.17	P11529TR-ND	3,000	65.00/M	LNJ311G8TRA
	Pure Green	Green Diffused	GaP	60	20	4	-30-85	0.7	0.25	10	2.03	2.6	565	P11531CT-ND	.23	2.1	.19	P11531TR-ND	3,000	76.01/M	LNJ311G8PRA
	High Bright Red	Red Diffused	GaAlAs	60	20	3	-30-85	7	2.3	10	1.72	2.5	660	P541CT-ND1	.18	.17	.16	P541TR-ND1	3,000	76.01/M	LNJ211R8ARU
	Orange	Red Diffused	GaAsP	60	20	3	-30-85	1.8	0.7	10	1.93	2.6	630	P11540CT-ND1	.21	.20	.18	P11540TR-ND1	3,000	70.51/M	LNJ181R8DRU
	Amber	Yellow Diffused	GaAsP	60	20	4	-30-85	2.2	0.75	10	2	2.6	590	P11596CT-ND1	.21	.20	.18	P11596TR-ND1	3,000	70.51/M	LNJ411K8YRU
	Yellow Green	Green Diffused	GaP	60	20	4	-30-85	5.5	1.8	10	2.03	2.6	565	P540CT-ND1	.18	.17	.16	P540TR-ND1	3,000	65.00/M	LNJ311G8TRU
<b>Ultra Bright InGaAlP / GaN LED</b>																					
6	Ultra Bright Red	Red Diffused	InGaAlP	55	20	4	-30-85	15	8	10	1.92	2.5	645	P11532CT-ND	.35	.33	.30	P11532TR-ND	3,000	141.01/M	LNJ211R82RA
	Orange	Red Diffused	InGaAlP	55	20	4	-30-85	32	17	10	2.03	2.5	630	P11533CT-ND	.35	.33	.30	P11533TR-ND	3,000	141.01/M	LNJ181R83RA
	Orange	Red Diffused	InGaAlP	50	20	4	-30-85	6.5	3.5	10	1.9	2.5	620	P11534CT-ND	.35	.33	.30	P11534TR-ND	3,000	141.01/M	LNJ811R88RA
	Soft Orange	Red Diffused	InGaAlP	55	20	4	-30-85	21	10	10	1.95	2.5	615	P11535CT-ND	.35	.33	.30	P11535TR-ND	3,000	141.01/M	LNJ811K87RA
	Amber	Yellow Diffused	InGaAlP	55	20	4	-30-85	17	9	10	2	2.5	595	P11536CT-ND	.35	.33	.30	P11536TR-ND	3,000	141.01/M	LNJ411K84RA
	Yellow Green	Green Diffused	InGaAlP	55	20	4	-30-85	12	6.4	10	2.03	2.5	575	P11537CT-ND	.35	.33	.30	P11537TR-ND	3,000	141.01/M	LNJ311G83RA
	Blue	White Diffused	GaN	40	10	5	-25-85	8.5	4.5	5	3.2	3.7	470	P11539CT-ND	2.29	2.15	2.01	P11539TR-ND	3,000	1043.77/M	LNJ611W88RA
	Pure Green	White Diffused	GaN	40	10	5	-25-85	34	14.4	5	3.2	3.7	525	P11538CT-ND	2.29	2.15	2.01	P11538TR-ND	3,000	1043.77/M	LNJ611W8WRA
	Amber	Yellow Diffused	InGaAlP	55	20	4	-30-85	17	9	10	2	2.5	595	P11541CT-ND1	.35	.33	.30	P11541TR-ND1	3,000	141.01/M	LNJ411K84RU
	Blue	White Diffused	InGaAlP	40	10	5	-25-85	8.5	4.5	5	3.2	3.7	470	P11543CT-ND1	2.29	2.15	2.01	P11543TR-ND1	3,000	1043.77/M	LNJ911W88RU
Pure Green	White Diffused	GaN	40	10	5	-25-85	34	14.4	5	3.2	3.7	525	P11542CT-ND1	2.29	2.15	2.01	P11542TR-ND1	3,000	1043.77/M	LNJ611W8WRU	
<b>1206 (3216) Leadless with Micro Lens Type</b>																					
6	High Bright Red	Red Diffused	GaAlAs	60	20	3	-30-85	10.5	4	10	1.72	2.5	660	P11511CT-ND	.23	.21	.19	P11511TR-ND	3,000	76.01/M	LNJ216C8ARA
	Orange	Clear Non Diffused	GaAsP	60	20	3	-30-85	2.1	1.1	10	1.93	2.6	630	P11512CT-ND	.21	.20	.18	P11512TR-ND	3,000	70.51/M	LNJ816C8DRA
	Soft Orange	Clear Non Diffused	GaAsP	60	20	3	-30-85	1.5	0.8	10	1.93	2.6	610	P11513CT-ND	.21	.20	.18	P11513TR-ND	3,000	70.51/M	LNJ816C8SRA
	Amber	Yellow Diffused	GaAsP	60	20	4	-30-85	3.3	1.2	10	2	2.6	590	P11514CT-ND	.21	.20	.18	P11514TR-ND	3,000	70.51/M	LNJ41608YRA
	Green	Green Diffused	GaP	60	20	4	-30-85	8.8	3.3	10	2.03	2.6	565	P11515CT-ND	.20	.18	.17	P11515TR-ND	3,000	65.00/M	LNJ316C8TRA
	Pure Green	Clear Non Diffused	GaP	60	20	4	-30-85	3.2	1.6	10	2.1	2.6	560	P11516CT-ND	.20	.18	.17	—	—	—	LNJ316C8ARA
	Red	Clear Non Diffused	GaAlAs	60	20	3	-30-85	10.5	4	10	1.72	2.5	660	P11544CT-ND1	.23	.21	.19	P11544TR-ND1	3,000	76.01/M	LNJ316C8PRA
	Orange	Clear Non Diffused	GaAsP	60	20	3	-30-85	2.1	1.1	10	1.93	2.6	630	P11545CT-ND1	.21	.20	.18	P11545TR-ND1	3,000	70.51/M	LNJ816C8DRU
	Amber	Yellow Clear Non Diff.	GaAsP	60	20	4	-30-85	3.3	1.2	10	2	2.6	590	P11546CT-ND1	.21	.20	.18	P11546TR-ND1	3,000	70.51/M	LNJ41608YRU
	Green	Clear Non Diffused	GaP	60	20	4	-30-85	8.8	3.3	10	2.03	2.6	565	P11547CT-ND1	.20	.18	.17	P11547TR-ND1	3,000	65.00/M	LNJ316C8TRU
<b>Ultra Bright InGaAlP / GaN LED</b>																					
6	Red	Clear Non Diffused	InGaAlP	55	20	4	-30-85	24	12.8	10	1.92	2.5	645	P11518CT-ND	.35	.33	.30	P11518TR-ND	3,000	141.01/M	LNJ216C82RA
	Orange	Clear Non Diffused	InGaAlP	55	20	4	-30-85	48	25	10	2.03	2.5	630	P11519CT-ND	.35	.33	.30	P11519TR-ND	3,000	141.01/M	LNJ816C83RA
	Orange	Clear Non Diffused	InGaAlP	55	20	4	-30-85	9.8	5.2	10	1.9	2.5	620	P11520CT-ND	.35	.33	.30	P11520TR-ND	3,000	141.01/M	LNJ816C88RA
	Soft Orange	Clear Non Diffused	InGaAlP	55	20	4	-30-85	30	16	10	1.95	2.5	615	P11521CT-ND	.35	.33	.30	P11521TR-ND	3,000	141.01/M	LNJ816C87RA
	Amber	Clear Non Diffused	InGaAlP	55	20	4	-30-85	26	13.8	10	2	2.5	595	P11522CT-ND	.35	.33	.30	P11522TR-ND	3,000	141.01/M	LNJ416C84RA
	Yellow Green	Clear Non Diffused	InGaAlP	55	20	4	-30-85	22	11	10	2.03	2.5	575	P11523CT-ND	.35	.33	.30	P11523TR-ND	3,000	141.01/M	LNJ316C83RA
	Blue	Clear Non Diffused	GaN	40	10	5	-25-85	12.8	6.8	15	3.2	3.7	470	P11525CT-ND							

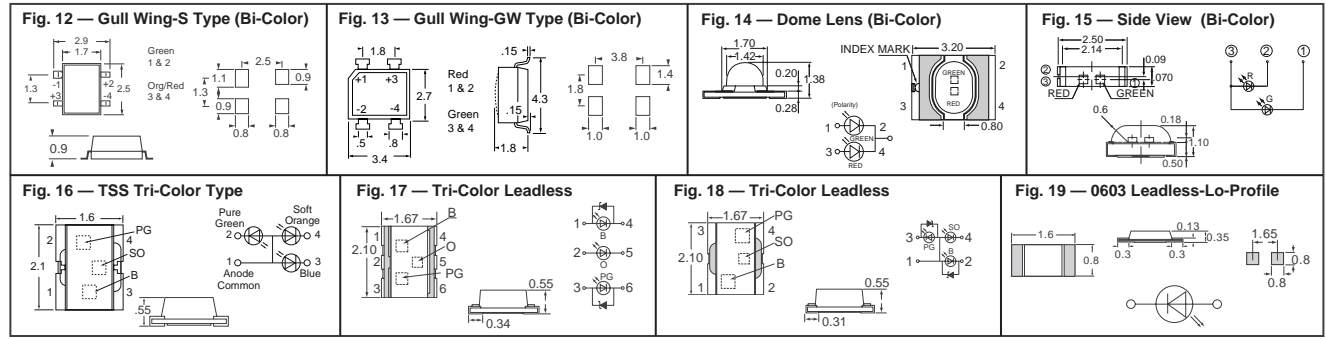

Fig.	Lighting Color	Lens	Process Tech.	Absolute Max. Ratings				I <sub>o</sub>		Rated IF	VF (V)		λP Typ.	Digi-Key Part No.	Cut Tape Price Each			Digi-Key Part No.	Tape & Reel		Panasonic Part No.
				(mW) PD	(mA) IF	(V) VR	(°C) Topr	(mcd) Typ.	(mcd) Min.		Typ.	Max.			1	10	100		Size	Pricing	
<b>Side Firing LED with Refractive Case</b>																					
8	Red	Clear	GaP	60	20	4	-25-80	0.7	0.25	10	2.03	2.6	700	P1138CT-ND	.22	.21	.19	P1138TR-ND	3,000	89.78/M	LNJ210C6RRA
	High Bright Red	Clear	GaAlAs	60	20	3	-25-80	0.8	2.6	10	1.72	2.5	660	P1139CT-ND	.22	.21	.19	P1139TR-ND	3,000	100.25/M	LNJ210C6ARA
	Orange	Red Clear	GaAsP	60	20	3	-25-80	2.5	0.8	10	1.93	2.6	630	P519CT-ND	.21	.20	.18	P519TR-ND	3,000	94.74/M	LNJ810L6DRA
	Soft Orange	Red Clear Non Diff.	GaAsP	60	20	3	-25-85	1.8	0.75	10	1.93	2.6	610	P11580CT-ND	.29	.27	.24	P11580TR-ND	3,000	94.74/M	LNJ810L6SRA
	Amber	Yellow Clear	GaAsP	60	20	4	-25-80	2.5	0.8	10	2	2.6	590	P11140CT-ND	.22	.21	.19	P11140TR-ND	3,000	94.74/M	LNJ41006YRA
	Yellow Green	Clear	GaP	60	20	4	-25-80	8	3	10	2.03	2.6	565	P520CT-ND	.21	.20	.18	P520TR-ND	3,000	89.78/M	LNJ310M6JURA
	Green	Clear Non Diffused	GaP	60	20	4	-25-85	3.2	1.7	10	2.1	2.6	560	P11581CT-ND	.28	.25	.23	P11581TR-ND	3,000	89.78/M	LNJ310C64ARA
	Pure Green	Clear Non Diffused	GaP	60	20	4	-25-85	1.1	0.6	10	2.03	2.6	555	P11582CT-ND	.31	.28	.25	P11582TR-ND	3,000	100.25/M	LNJ310C6PRA
White	White Diffused	GaN	120	30	5	-25-80	260	180	10	3.4	3.9	—	P12024CT-ND	3.18	2.97	2.69	P12024TR-ND	3,000	1288.88/M	LNJ010X6FRA	
<b>Ultra Bright InGaAlP LED</b>																					
8	Ultra Bright Red	Clear Non Diffused	InGaAlP	55	20	4	-25-85	23	12	10	1.92	2.5	645	P11583CT-ND	.40	.38	.34	P11583TR-ND	3,000	161.39/M	LNJ210C62ARA
	Orange	Clear Non Diffused	InGaAlP	55	20	4	-25-85	48	25	10	2.03	2.5	620	P11584CT-ND	.40	.38	.34	P11584TR-ND	3,000	100.25/M	LNJ810C6ARA
	Soft Orange	Clear Non Diffused	InGaAlP	55	20	4	-25-85	45	24	10	1.95	2.5	620	P11585CT-ND	.40	.38	.34	P11585TR-ND	3,000	161.39/M	LNJ810C68ARA
	Amber	Clear Non Diffused	InGaAlP	50	20	4	-25-80	30	12	10	1.95	2.5	615	P11586CT-ND	.40	.38	.34	P11586TR-ND	3,000	161.39/M	LNJ810C67ARA
	Yellow Green	Clear Non Diffused	InGaAlP	50	20	4	-25-80	22.5	8.5	10	2	2.5	595	P11587CT-ND	.40	.38	.34	P11587TR-ND	3,000	161.39/M	LNJ410C64ARA
<b>Gull Wing GW Type with Refractive Case</b>																					
9	Red	Clear	GaP	60	20	4	-25-80	1.4	0.5	15	2.2	2.8	700	P503CT-ND	.18	.17	.16	P503TR-ND	2,000	70.50/M	LNJ261CTR
	High Bright Red	Clear	GaAlAs	60	20	3	-25-80	1.2	5	20	1.8	2.6	660	P513CT-ND	.24	.23	.21	P513TR-ND	2,000	81.52/M	LNJ261CALTR
	Orange	Clear	GaAsP	60	20	3	-25-80	5	1.9	20	2.1	2.8	630	P505CT-ND	.18	.17	.16	P505TR-ND	2,000	76.01/M	LNJ1861CTR
	Amber	Clear	GaAsP	60	20	4	-25-80	4.5	1.6	20	2.2	2.8	590	P512CT-ND	.19	.17	.16	P512TR-ND	2,000	76.01/M	LNJ1461CTR
	Yellow Green	Clear	GaP	60	20	4	-25-80	7.5	2.8	20	2.2	2.8	565	P504CT-ND	.18	.17	.16	P504TR-ND	2,000	70.50/M	LNJ1361CTR
	High Bright Yellow Green	Clear	GaP	60	20	4	-25-80	15	8	20	2.2	2.8	565	P514CT-ND	.21	.20	.18	P514TR-ND	2,000	70.50/M	LNJ361C3UR01
<b>Ultra Bright InGaAlP LED</b>																					
9	Amber	Clear	InGaAlP	50	20	4	-25-80	18	6.5	10	2	2.3	595	P1128CT-ND	.32	.30	.27	P1128TR-ND	2,000	152.02/M	LNJ461C3ARA
<b>1206 (3216) J-Lead J Type with Refractive Case</b>																					
10	Red	Clear	GaAsP	45	15	4	-25-80	1.2	0.45	10	2.1	2.8	700	P500CT-ND	.18	.17	.16	P500TR-ND	3,000	70.51/M	LNJ251CTR
	High Bright Red	Clear	GaAlAs	45	15	3	-25-80	9	3.3	10	1.75	2.6	660	P11126CT-ND	.24	.23	.21	P11126TR-ND	3,000	81.52/M	LNJ261CALTR
	Orange	Clear	GaAsP	45	15	3	-25-80	3.5	1.3	10	0.05	2.8	630	P502CT-ND	.18	.17	.16	P502TR-ND	3,000	76.01/M	LNJ1851CTR
	Amber	Clear	GaAsP	45	15	4	-25-80	2.2	0.8	10	2.1	2.8	590	P511CT-ND	.18	.17	.16	P511TR-ND	3,000	76.01/M	LNJ1451CTR
	Yellow Green	Clear	GaP	45	15	4	-25-80	5	1.9	10	2.1	2.8	565	P501CT-ND	.18	.17	.16	P501TR-ND	3,000	70.51/M	LNJ1351CTR
<b>Ultra Bright GaN LED</b>																					
10	Blue	Clear	GaN	40	10	5	-25-80	9	3	5	3.0	3.7	470	P11127CT-ND	2.11	1.94	1.76	P11127TR-ND	3,000	1043.77/M	LNJ951C4BRA
	Pure Green	Clear	GaN	40	10	5	-25-80	6	3.2	5	3.2	3.7	525	P628CT-ND	2.11	1.94	1.76	P628TR-ND	3,000	1043.77/M	LNJ651C4WRA
<b>Leadless TSS- Type Bi-Color</b>																					
11	Yellow Green	White Diffused	GaP	60	20	4	-30-85	5	1.8	10	2.03	2.6	565	P11142CT-ND	.44	.41	.37	P11142TR-ND	5,000	93.64/M	LNJ115W8ARA
	Orange	White Diffused	GaAsP	60	20	3	-30-85	1	0.4	10	1.93	2.6	630	P11143CT-ND	.44	.41	.37	P11143TR-ND	5,000	103.55/M	LNJ115W8PRA
	High Bright Red	White Diffused	GaAlAs	50	20	3	-30-85	6.7	2.2	10	1.72	2.5	655	—	—	—	—	—	—	—	
<b>Ultra Bright InGaAlP / GaN LED Combination</b>																					
11	Yellow Green	White Diffused	GaP	60	20	4	-30-85	5	1.8	10	2.03	2.6	565	P11144CT-ND	.61	.57	.52	P11144TR-ND	5,000	246.76/M	LNJ115W88RA
	Amber	White Diffused	InGaAlP	55	20	4	-30-85	21	7	10	2.1	2.6	595	—	—	—	—	—	—	—	
	Yellow Green	White Diffused	GaP	60	20	4	-30-85	5	1.8	10	2.03	2.6	565	P11591CT-ND	.67	.63	.57	P11591TR-ND	5,000	246.76/M	LNJ115W89RA
	Soft Orange	White Diffused	InGaAlP	55	20	3	-30-85	21	7	10	1.95	2.5	615	—	—	—	—	—	—	—	
	Pure Green	White Diffused	GaN	40	10	5	-30-85	34	12.9	5	3	3.7	525	P11590CT-ND	3.10	2.90	2.71	P11590TR-ND	5,000	1283.92/M	LNJ115W86RA
	High Bright Red	White Diffused	GaAlAs	55	20	3	-30-85	6.7	2.8	10	1.72	2.5	655	—	—	—	—	—	—	—	
	Blue	White Diffused	GaN	40	10	5	-30-85	8.5	4	5	3.2	3.7	470	P11589CT-ND	3.10	2.90	2.71	P11589TR-ND	5,000	1283.92/M	LNJ115W8HRA
	High Bright Red	White Diffused	GaAlAs	55	20	3	-30-85	6.7	2.8	10	1.72	2.5	655	—	—	—	—	—	—	—	
Pure Green	White Diffused	GaN	40	10	5	-30-85	34	10.3	5	3	3.7	525	P11145CT-ND	3.18	2.92	2.66	P11145TR-ND	5,000	1283.92/M	LNJ115W8VRA	
<b>S-GW Gull Wing Type Bi-Color</b>																					
12	High Bright Yellow Green	White Diffused	GaP	60	20	4	-25-85	5	3	10	2.03	2.6	565	P526CT-ND	.41	.38	.35	P526TR-ND	3,000	130.54/M	LNJ107W5PRW
	High Bright Red	White Diffused	GaAlAs	60	20	3	-25-85	5	1.7	10	1.72	2.5	660	—	—	—	—	—	—	—	
	Yellow Green	White Diffused	GaP	60	20	4	-25-85	2.6	0.9	10	2.03	2.6	565	P515CT-ND	.41	.38	.35	P515TR-ND	3,000	119.53/M	LNJ107W5ARA1
<b>Gull Wing Type Bi-Color with Refractive Case</b>																					
13	Green	Clear	GaP	45	15	4	-25-80	4	1.5	10	2.05	2.8	650	P507CT-ND	.41	.38	.35	P507TR-ND	1,000	141.00	LN2162C13TR
	Red	Clear	GaAsP	45	15	3	-25-80	1.8	0.65	10	2	2.8	650	—	—	—	—	—	—	—	
	Pure Green	Clear	GaAsP	45	15	3	-25-65	2.5	1.2	10	2.05	2.8	555	P11147CT-ND	.44	.41	.37	P11147TR-ND	1,000	141.00	LN2162C68TR
<b>Dome Lens Leadless Bi-Color LED</b>																					
14	Yellow/Green	White Diffused	GaP	60	20	4	-30-85	10	5	10	2.03	2.6	565	P594CT-ND	.47	.44	.40	P594TR-ND	2,500	208.21/M	LNJ121W84RA
	High Bright Red	White Diffused	InGaAlP	55	20	4	-30-85	13.4	7	10	1.92	2.5	645	—	—	—	—	—	—	—	
<b>Side View Smaller Size Leadless Bi-Color LED</b>																					
15	Yellow/Green	White Diffused	GaP	60	20	4	-30-85	5	1.8	10	2.03	2.6	565	P593CT-ND	.47	.44	.40	P593TR-ND	4,000	208.21/M	LNJ123W8PRZ
	High Bright Red	White Diffused	GaAlAs	50	20	3	-30-85	4	1.5	10	1.72	2.5	655	—	—	—	—	—	—	—	
<b>Tri-Color Leadless LED Ultra Bright LED Combination</b>																					
16	Blue	White Diffused	InGaN	40	10	5	-30-85	8.5	3.2	5	3.2	3.7	470	—	—	—	—	—	—	—	
	Pure Green	White Diffused	InGaN	40	10	5	-30-85	34	10.3	5	3	3.7	525	P11146CT-ND	6.12	5.62	5.11	P11146TR-ND	2,000	2496.78/M	LNJ171W80RA
	Soft Orange	White Diffused	InGaAlP	55	20	4	-30-85	23	7	10	1.95	2.5	615	—	—	—	—	—	—	—	
17	Blue	White Diffused	GaN	65	15	4	-30-85	35	10	5	3.1	3.7	470	P11592CT-ND	5.77	5.41	5.05	P11592TR-ND	2,000	2630.62/M	LNJ171W83RAS
	Pure Green	White Diffused	GaN	65	15	4	-30-85	85	50	5	3.1	3.7	525	—	—	—	—	—	—	—	
	Orange	White Diffused	InGaAlP	70	20	4	-30-85	45	15	10	2	2.5	630	—	—	—	—	—	—	—	
18	Blue	White Diffused	GaN	65	15	4	-30-85	30	18	5	3.1	3.7	470	—	—						