2.5 mW 14 Pin DIL Cooled Laser Module

Technical Data

LSC2110-622

Features

- **2.5 Milliwatt Peak Optical Power Output**
- **Center Wavelength between 1294 nm and 1329 nm**
- **Narrow Linewidth: <1.7 nm**
- **Modulation Bandwidth: >1 Ghz**
- **Wide Operating Temperature Range: -40°C to +85°C**
- **Industry Standard Hermetic 14 Pin Dual-In-Line Package**

Applications

- **622 Mbit/s SONET/SDH**
- **Local Area and Metropolitan Area Networks**
- **Point-to-Point Data Communications**
- **Fiber Optic Sensors**
- **Cable Television**
- **Military Communications and Control Systems**
- **Instrumentation**

Description

LSC2110-622 laser modules are highly reliable fiber optic light sources operating in the 1300 nanometer band. The internal semiconductor lasers are based upon InGaAsP buried heterostructure (BH) technology and fabricated by the Metal Organic Vapor Phase Epitaxy (MOVPE) process, resulting in long lifetimes and modest threshold currents.

LSC2110-622 package includes a photodiode for monitoring the laser output, a thermistor for monitoring the laser submodule temperature and a Peltier effect thermoelectric cooler (TEC). A heatsink mounting flange is incorporated into the industry standard 14 pin package.

The LSC2110-622 has been specifically designed to meet the requirements of STM4.1 and SONET OC12 LR1 applications.



Laser Safety Warning

This device is a Class IIIb (3b) Laser Product. It may emit invisible laser radiation if operated with the fiber pigtail disconnected. To avoid possible eye damage do not look into an unconnected fiber pigtail during laser operation. Do not exceed specified operating limits.

Pin Connections

Top View

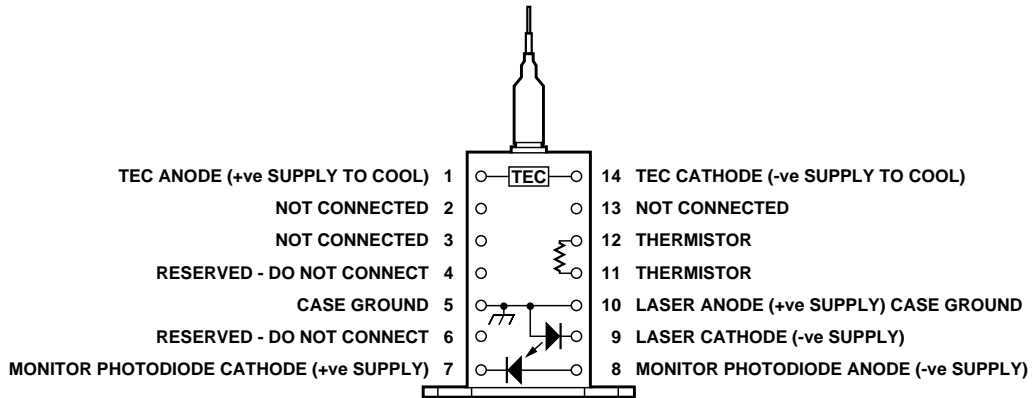

Mechanical Outline

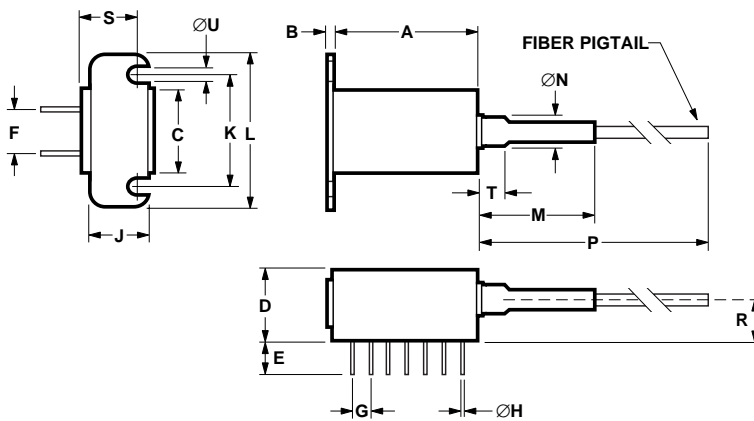

DIM.	MIN.	MAX.	DIM.	MIN.	MAX.
A	20.68	20.98	K	19.05 NOM.	
B	0.90	1.10	L	25.10	25.70
C	12.55	13.00	M	30.00 NOM.	
D	8.51	9.60	ØN	-	4.20
E	6.10	6.60	P	1000	-
F	7.62 NOM.		R	5.80	6.20
G	2.54 NOM.		S	6.00 NOM.	
ØH	0.457 NOM.		T	-	6.00
J	7.01	7.21	ØU	3.17 NOM.	

ALL DIMENSIONS IN MILLIMETERS

LSC2110-622 Typical Operating Characteristics

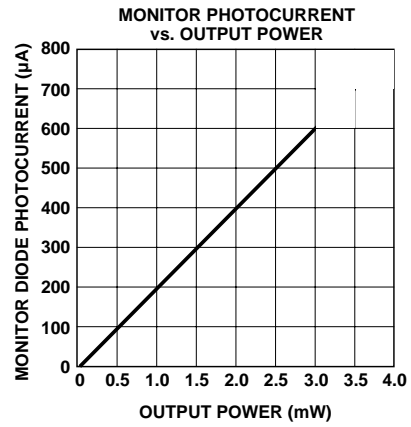
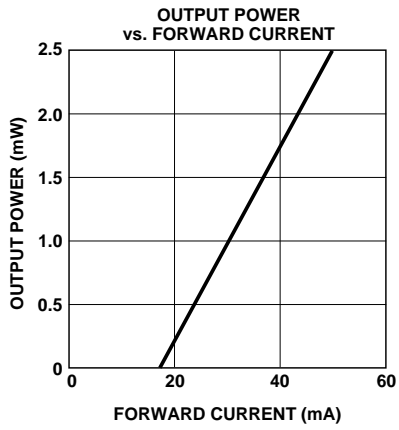
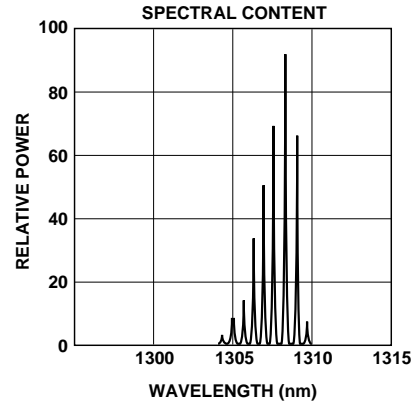
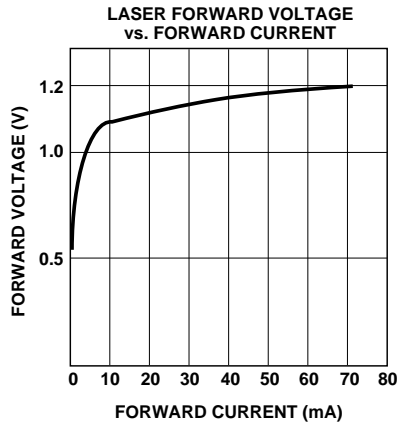

Absolute Maximum Ratings

Absolute maximum limits mean that no catastrophic damage will occur if the product is subjected to these ratings for short periods, provided each limiting parameter is in isolation and all other parameters have values within the performance specification. It should not be assumed that limiting values of more than one parameter can be applied to the product at the same time.

Parameter	Symbol	Conditions	Limits		Units
			Min.	Max.	
Laser Forward Current	If	DC	-	150	mA
Laser Reverse Current	Ir	DC	-	100	μA
Laser Reverse Voltage	Vlr	DC	-	2	V
Photodiode Reverse Voltage	Vr	DC	-	10	V
Photodiode Forward Current	Ipf	DC	-	1	mA
Operating Temperature	Tc	Pf min.	-40	+85	°C
Storage Temperature	Ts		-40	+85	°C
Relative Humidity	RH		0.0	non-condensing	%RH
Fiber Pull Strength			-	10	N
Mechanical Shock		Mil Std 883, Method 2002, Condition A			
Vibration		Mil Std 883, Method 2007, Condition A			

Performance Specification

Parameter	Symbol	Test Conditions	Min.	Max.	Units
LASER		Tc = -40°C to +85°C, ΔT = +65°C (heating) ΔT = -40°C (cooling), CW, Pf = 2.5 mW unless otherwise stated			
Threshold Current	Ith		5	25	mA
Peak Optical Output Power	Pf		2.5	-	mW
	Pf		4	-	dBm
Optical Output Power	Pth	Pth = Pf @ Ith -2 mA	-	50	μW
Slope Efficiency	η	Tc = 25°C, Rt = 10 kΩ	0.05	0.12	mW/mA
Forward Voltage	Vf		-	1.8	V
Differential Resistance	Rd	dV/dI	-	10	Ω
Centre Wavelength	λc	Mod @ 622 Mbit/s, 50% duty cycle, ORL 20 dB	1294	1329	nm
λc Change with Temperature	Δλc/ΔT	From Tc = 65°C to 85°C, ΔT = -40°C	-	0.5	nm/°C
Spectral Width	Δλ	Modulated as for λc, 1 x σ, RMS	-	1.7	nm
Rise Time	τr	10% to 90%: Ith to Pf = 2.5 mW	-	0.4	ns
Fall Time	τf	90% to 10%: Pf = 2.5 mW to Ith	-	0.4	ns
Small Signal Freq. Response	Bw	± 3 dB	1.0	-	GHz

Performance Specifications (cont'd.)

Parameter	Symbol	Test Conditions	Ratings		Units
			Min.	Max.	
MONITOR PHOTODIODE		Tc = -40°C to +85°C, ΔT = +65°C (heating) ΔT = -40°C (cooling), CW, Pf = 2.5 mW Vr = 5 V (Note 1), unless otherwise specified			
Photocurrent	Im		0.1	2.0	mA
Responsivity	R		0.04	0.8	A/W
Dark Current	Id	Pf = 0 mW, Tc = ~25°C, Rt = 10 kΩ	-	20	nA
Tracking Error	ΔR	Im = Im @ (Pf = 2.5 mW, Tc = 25°C)	-	± 0.5	dB

Note:

1. Monitor Photodiode will also operate under zero bias conditions.

Parameter	Symbol	Test Conditions	Ratings		Units
			Min.	Max.	
THERMISTOR		Tc = 25°C, unless otherwise specified			
Resistance	Rt		9.5	10.5	kΩ
Temperature Coefficient of Rt	ΔRt/ΔT		Typ -4.4		%dR/°C
β Constant	β	0°C to 50°C	Typ 3900		°K

Parameter	Symbol	Test Conditions	Ratings		Units
			Min.	Max.	
TEC		Pf = 2.5 mW, unless otherwise specified			
TEC Cooling Current	Ic	ΔT = -40°C, Tc = 85°C	-	1.0	A
TEC Heating Current	Ih	ΔT = 65°C, Tc = -40°C	-	1.0	A
Voltage	Vc	ΔT = -40°C to 65°C	-	2.0	V

Fiber Pigtail: Tight jacketed, self-mode stripping, single mode fiber

Parameter	Minimum	Maximum	Units
Length	1.0	-	m
Spot Size (Mode Radius)	4.5	5.5	μm
Cladding Diameter	122	128	μm
Core/Cladding Concentricity	-	1.0	μm
Secondary Jacket Diameter	0.8	1.0	mm
Effective Cutoff Wavelength	1150	1240	nm

Ordering Information

LSC2110 - 622 - XX

Connector Type:
FP = FC/PC
ST = ST®
SC = SC
DN = DIN
BI = Biconic
SA = SMA
SF = Super Polish FC/PC

Handling Precautions

1. The LSC2110-622 can be damaged by current surges or overvoltage.
2. Power supply transient precautions should be taken.
3. Normal handling precautions for electrostatic sensitive devices should be taken.

CDRH Certification

Hewlett-Packard Ltd
Whitehouse Road
Ipswich, Suffolk IP1 5PB
England

Manufactured: _____ Serial No. _____
Model No. _____

This product conforms to the applicable requirements of 21 CFR 1040 at the date of manufacture.

Laser Warning

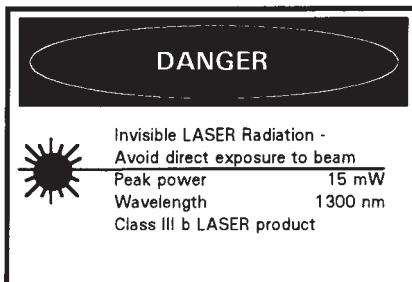

ST® is a Registered Trademark of AT&T.