

## FEATURES

- **Low Noise Voltage: 1.9nV/ $\sqrt{\text{Hz}}$**
- **Low Supply Current: 1.15mA/Amp Max**
- **Low Offset Voltage: 350 $\mu\text{V}$  Max**
- Gain Bandwidth Product:  
 LT6233: 60MHz;  $A_V \geq 1$   
 LT6233-10: 375MHz;  $A_V \geq 10$
- Wide Supply Range: 3V to 12.6V
- Output Swings Rail-to-Rail
- Common Mode Rejection Ratio 115dB Typ
- Output Current: 30mA
- Operating Temperature Range  $-40^\circ\text{C}$  to  $85^\circ\text{C}$
- LT6233 Shutdown to 10 $\mu\text{A}$  Maximum
- LT6233/LT6233-10 in SOT-23 Package
- Dual LT6234 in Tiny DFN Package

## APPLICATIONS

- Ultrasound Amplifiers
- Low Noise, Low Power Signal Processing
- Active Filters
- Driving A/D Converters
- Rail-to-Rail Buffer Amplifiers

LT, LTC and LT are registered trademarks of Linear Technology Corporation.

## DESCRIPTION

The LT<sup>®</sup>6233/LT6234/LT6235 are single/dual/quad low noise, rail-to-rail output unity gain stable op amps that feature 1.9nV/ $\sqrt{\text{Hz}}$  noise voltage and draw only 1.15mA of supply current per amplifier. These amplifiers combine very low noise and supply current with a 60MHz gain bandwidth product, a 17V/ $\mu\text{s}$  slew rate and are optimized for low supply voltage signal conditioning systems. The LT6233-10 is a single amplifier optimized for higher gain applications resulting in higher gain bandwidth and slew rate. The LT6233 and LT6233-10 include an enable pin that can be used to reduce the supply current to less than 10 $\mu\text{A}$ .

The amplifier family has an output that swings within 50mV of either supply rail to maximize the signal dynamic range in low supply applications and is specified on 3.3V, 5V and  $\pm 5\text{V}$  supplies. The  $e_n \cdot \sqrt{I_{\text{SUPPLY}}}$  product of 2.1 per amplifier is among the most noise efficient of any op amp.

The LT6233/LT6233-10 is available in the 6-lead SOT-23 package and the LT6234 dual is available in the 8-pin SO package with standard pinouts. For compact layouts, the dual is also available in a tiny dual fine pitch leadless package (DFN). The LT6235 is available in the 16-pin SSOP package.

## TYPICAL APPLICATION

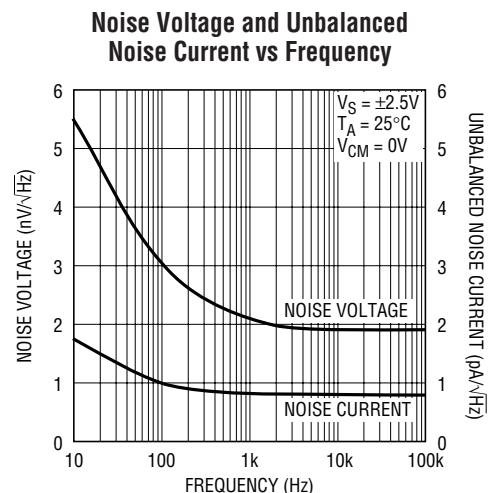
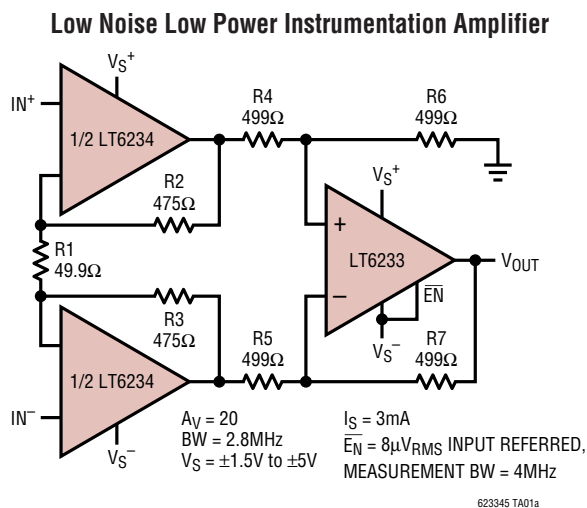

# LT6233/LT6233-10/ LT6234/LT6235

## ABSOLUTE MAXIMUM RATINGS (Note 1)

Total Supply Voltage ( $V^+$ to $V^-$ ) .....	12.6V	Junction Temperature .....	150°C
Input Current (Note 2) .....	$\pm 40\text{mA}$	Junction Temperature (DD Package) .....	125°C
Output Short-Circuit Duration (Note 3) .....	Indefinite	Storage Temperature Range .....	$-65^\circ\text{C}$ to $150^\circ\text{C}$
Operating Temperature Range (Note 4) ...	$-40^\circ\text{C}$ to $85^\circ\text{C}$	Storage Temperature Range (DD Package) .....	$-65^\circ\text{C}$ to $125^\circ\text{C}$
Specified Temperature Range (Note 5) ....	$-40^\circ\text{C}$ to $85^\circ\text{C}$	Lead Temperature (Soldering, 10 sec) .....	$300^\circ\text{C}$

## PACKAGE/ORDER INFORMATION

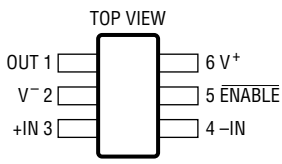
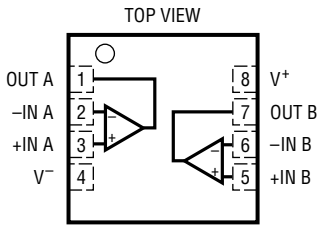
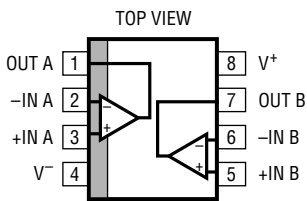
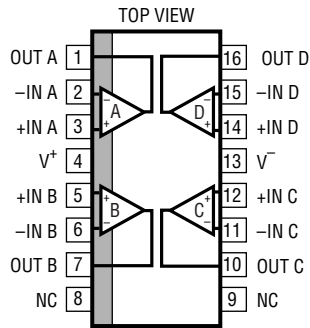
 <p>TOP VIEW</p> <p>OUT 1 6 <math>V^+</math>  <math>V^-</math> 2 5 ENABLE            +IN 3 4 -IN</p> <p>S6 PACKAGE            6-LEAD PLASTIC SOT-23  <math>T_{JMAX} = 150^\circ\text{C}</math>, <math>\theta_{JA} = 250^\circ\text{C/W}</math></p>	ORDER PART NUMBER	 <p>TOP VIEW</p> <p>OUT A 1 <math>V^+</math>            -IN A 2 OUT B 7            +IN A 3 -IN B 6  <math>V^-</math> 4 +IN B 5</p> <p>DD PACKAGE            8-LEAD (3mm x 3mm) PLASTIC DFN  <math>T_{JMAX} = 125^\circ\text{C}</math>, <math>\theta_{JA} = 160^\circ\text{C/W}</math>            UNDERSIDE METAL CONNECTED TO <math>V^-</math>            (PCB CONNECTION OPTIONAL)</p>	ORDER PART NUMBER	
	LT6233CS6 LT6233IS6 LT6233CS6-10 LT6233IS6-10		DD PART MARKING*	LT6234CDD LT6234IDD
	S6 PART MARKING*		LAET	
 <p>TOP VIEW</p> <p>OUT A 1 8 <math>V^+</math>            -IN A 2 OUT B 7            +IN A 3 -IN B 6  <math>V^-</math> 4 +IN B 5</p> <p>S8 PACKAGE            8-LEAD PLASTIC SO  <math>T_{JMAX} = 150^\circ\text{C}</math>, <math>\theta_{JA} = 190^\circ\text{C/W}</math></p>	ORDER PART NUMBER	 <p>TOP VIEW</p> <p>OUT A 1 16 OUT D            -IN A 2 15 -IN D            +IN A 3 14 +IN D  <math>V^+</math> 4 13 <math>V^-</math>            +IN B 5 12 +IN C            -IN B 6 11 -IN C            OUT B 7 10 OUT C            NC 8 9 NC</p> <p>GN PACKAGE            16-LEAD NARROW PLASTIC SSOP  <math>T_{JMAX} = 150^\circ\text{C}</math>, <math>\theta_{JA} = 135^\circ\text{C/W}</math></p>	ORDER PART NUMBER	
	LT6234CS8 LT6234IS8		GN PART MARKING	LT6235CGN LT6235IGN
	S8 PART MARKING		6235 6235I	
	6234 6234I			

\*The temperature grade is identified by a label on the shipping container. Consult LTC Marketing for parts specified with wider operating temperature ranges.

**ELECTRICAL CHARACTERISTICS**  $T_A = 25^\circ\text{C}$ ,  $V_S = 5\text{V}$ ,  $0\text{V}$ ;  $V_S = 3.3\text{V}$ ,  $0\text{V}$ ;  $V_{\text{CM}} = V_{\text{OUT}} = \text{half supply}$ ,  
 $\text{ENABLE} = 0\text{V}$ , unless otherwise noted.

SYMBOL	PARAMETER	CONDITIONS	MIN	TYP	MAX	UNITS
$V_{\text{OS}}$	Input Offset Voltage	LT6233S6, LT6233S6-10		100	500	$\mu\text{V}$
		LT6234S8, LT6235GN		50	350	$\mu\text{V}$
		LT6234DD		75	450	$\mu\text{V}$
	Input Offset Voltage Match (Channel-to-Channel) (Note 6)			80	450	$\mu\text{V}$
$I_B$	Input Bias Current			1.5	3	$\mu\text{A}$
	$I_B$ Match (Channel-to-Channel) (Note 6)			0.04	0.3	$\mu\text{A}$
$I_{\text{OS}}$	Input Offset Current			0.04	0.3	$\mu\text{A}$
	Input Noise Voltage	0.1Hz to 10Hz		220		$\text{nV}_{\text{P-P}}$
$e_n$	Input Noise Voltage Density	$f = 10\text{kHz}$ , $V_S = 5\text{V}$		1.9	3	$\text{nV}/\sqrt{\text{Hz}}$
$i_n$	Input Noise Current Density, Balanced Source Unbalanced Source	$f = 10\text{kHz}$ , $V_S = 5\text{V}$ , $R_S = 10\text{k}$		0.43		$\text{pA}/\sqrt{\text{Hz}}$
		$f = 10\text{kHz}$ , $V_S = 5\text{V}$ , $R_S = 10\text{k}$		0.78		$\text{pA}/\sqrt{\text{Hz}}$
$C_{\text{IN}}$	Input Capacitance	Common Mode		2.5		$\text{pF}$
		Differential Mode		4.2		$\text{pF}$
$A_{\text{VOL}}$	Large-Signal Gain	$V_S = 5\text{V}$ , $V_O = 0.5\text{V}$ to $4.5\text{V}$ , $R_L = 10\text{k}$ to $V_S/2$ $R_L = 1\text{k}$ to $V_S/2$	73	140		$\text{V}/\text{mV}$
		$V_S = 3.3\text{V}$ , $V_O = 0.65\text{V}$ to $2.65\text{V}$ , $R_L = 10\text{k}$ to $V_S/2$ $R_L = 1\text{k}$ to $V_S/2$	18	35		$\text{V}/\text{mV}$
$V_{\text{CM}}$	Input Voltage Range	Guaranteed by CMRR, $V_S = 5\text{V}$ , $0\text{V}$ $V_S = 3.3\text{V}$ , $0\text{V}$	1.5		4	$\text{V}$
			1.15		2.65	$\text{V}$
CMRR	Common Mode Rejection Ratio	$V_S = 5\text{V}$ , $V_{\text{CM}} = 1.5\text{V}$ to $4\text{V}$ $V_S = 3.3\text{V}$ , $V_{\text{CM}} = 1.15\text{V}$ to $2.65\text{V}$	90	115		$\text{dB}$
			85	110		$\text{dB}$
	CMRR Match (Channel-to-Channel) (Note 6)	$V_S = 5\text{V}$ , $V_{\text{CM}} = 1.5\text{V}$ to $4\text{V}$	90	115		$\text{dB}$
PSRR	Power Supply Rejection Ratio	$V_S = 3\text{V}$ to $10\text{V}$	90	115		$\text{dB}$
			95	115		$\text{dB}$
	Minimum Supply Voltage (Note 7)		3			$\text{V}$
$V_{\text{OL}}$	Output Voltage Swing LOW (Note 8)	No Load		4	40	$\text{mV}$
		$I_{\text{SINK}} = 5\text{mA}$		75	180	$\text{mV}$
		$V_S = 5\text{V}$ , $I_{\text{SINK}} = 15\text{mA}$		165	320	$\text{mV}$
		$V_S = 3.3\text{V}$ , $I_{\text{SINK}} = 10\text{mA}$		125	240	$\text{mV}$
$V_{\text{OH}}$	Output Voltage Swing HIGH (Note 8)	No Load		5	50	$\text{mV}$
		$I_{\text{SOURCE}} = 5\text{mA}$		85	195	$\text{mV}$
		$V_S = 5\text{V}$ , $I_{\text{SOURCE}} = 15\text{mA}$		220	410	$\text{mV}$
		$V_S = 3.3\text{V}$ , $I_{\text{SOURCE}} = 10\text{mA}$		165	310	$\text{mV}$
$I_{\text{SC}}$	Short-Circuit Current	$V_S = 5\text{V}$	$\pm 40$	$\pm 55$		$\text{mA}$
		$V_S = 3.3\text{V}$	$\pm 35$	$\pm 50$		$\text{mA}$
$I_S$	Supply Current per Amplifier			1.05	1.15	$\text{mA}$
	Disabled Supply Current per Amplifier	$\text{ENABLE} = V^+ - 0.35\text{V}$		0.2	10	$\mu\text{A}$

# LT6233/LT6233-10/ LT6234/LT6235

## ELECTRICAL CHARACTERISTICS $T_A = 25^\circ\text{C}$ , $V_S = 5\text{V}$ , $0\text{V}$ ; $V_S = 3.3\text{V}$ , $0\text{V}$ ; $V_{CM} = V_{OUT} = \text{half supply}$ , $\text{ENABLE} = 0\text{V}$ , unless otherwise noted.

SYMBOL	PARAMETER	CONDITIONS	MIN	TYP	MAX	UNITS
$I_{\text{ENABLE}}$	ENABLE Pin Current	$\overline{\text{ENABLE}} = 0.3\text{V}$		-25	-75	$\mu\text{A}$
$V_L$	ENABLE Pin Input Voltage LOW				0.3	V
$V_H$	ENABLE Pin Input Voltage HIGH		$V^+ - 0.35$			V
	Output Leakage Current	$\overline{\text{ENABLE}} = V^+ - 0.35\text{V}$ , $V_O = 1.5\text{V to } 3.5\text{V}$		0.2	10	$\mu\text{A}$
$t_{\text{ON}}$	Turn-On Time	$\overline{\text{ENABLE}} = 5\text{V to } 0\text{V}$ , $R_L = 1\text{k}$ , $V_S = 5\text{V}$		500		ns
$t_{\text{OFF}}$	Turn-Off Time	$\overline{\text{ENABLE}} = 0\text{V to } 5\text{V}$ , $R_L = 1\text{k}$ , $V_S = 5\text{V}$		76		$\mu\text{s}$
GBW	Gain Bandwidth Product	Frequency = 1MHz, $V_S = 5\text{V}$ LT6233-10		55 320		MHz MHz
SR	Slew Rate	$V_S = 5\text{V}$ , $A_V = -1$ , $R_L = 1\text{k}$ , $V_O = 0.5\text{V to } 4.5\text{V}$	10	15		$\text{V}/\mu\text{s}$
		LT6233-10, $V_S = 5\text{V}$ , $A_V = -10$ , $R_L = 1\text{k}$ , $V_O = 0.5\text{V to } 4.5\text{V}$		80		$\text{V}/\mu\text{s}$
FPBW	Full Power Bandwidth	$V_S = 5\text{V}$ , $V_{\text{OUT}} = 3V_{\text{P-P}}$ (Note 9)	1.06	1.6		MHz
		LT6233-10, $\text{HD}_2 = \text{HD}_3 \leq 1\%$		2.2		MHz
$t_S$	Settling Time (LT6233, LT6234, LT6235)	0.1%, $V_S = 5\text{V}$ , $V_{\text{STEP}} = 2\text{V}$ , $A_V = -1$ , $R_L = 1\text{k}$		175		ns

The ● denotes the specifications which apply over  $0^\circ\text{C} < T_A < 70^\circ\text{C}$  temperature range.  $V_S = 5\text{V}$ ,  $0\text{V}$ ;  $V_S = 3.3\text{V}$ ,  $0\text{V}$ ;  $V_{CM} = V_{OUT} = \text{half supply}$ ,  $\text{ENABLE} = 0\text{V}$ , unless otherwise noted.

SYMBOL	PARAMETER	CONDITIONS	MIN	TYP	MAX	UNITS
$V_{\text{OS}}$	Input Offset Voltage	LT6233S6, LT6233S6-10	●		600	$\mu\text{V}$
		LT6234S8, LT6235GN	●		450	$\mu\text{V}$
		LT6234DD	●		550	$\mu\text{V}$
	Input Offset Voltage Match (Channel-to-Channel) (Note 6)		●		500	$\mu\text{V}$
$V_{\text{OS TC}}$	Input Offset Voltage Drift (Note 10)	$V_{CM} = \text{Half Supply}$	●	0.5	3.0	$\mu\text{V}/^\circ\text{C}$
$I_B$	Input Bias Current		●		3.5	$\mu\text{A}$
		$I_B$ Match (Channel-to-Channel) (Note 6)	●		0.4	$\mu\text{A}$
$I_{\text{OS}}$	Input Offset Current		●		0.4	$\mu\text{A}$
$A_{\text{VOL}}$	Large-Signal Gain	$V_S = 5\text{V}$ , $V_O = 0.5\text{V to } 4.5\text{V}$ , $R_L = 10\text{k to } V_S/2$	●	47		$\text{V}/\text{mV}$
		$R_L = 1\text{k to } V_S/2$	●	12		$\text{V}/\text{mV}$
		$V_S = 3.3\text{V}$ , $V_O = 0.65\text{V to } 2.65\text{V}$ , $R_L = 10\text{k to } V_S/2$	●	40		$\text{V}/\text{mV}$
		$R_L = 1\text{k to } V_S/2$	●	7.5		$\text{V}/\text{mV}$
$V_{CM}$	Input Voltage Range	Guaranteed by CMRR, $V_S = 5\text{V}$ , $0\text{V}$	●	1.5	4	V
		$V_S = 3.3\text{V}$ , $0\text{V}$	●	1.15	2.65	V
CMRR	Common Mode Rejection Ratio	$V_S = 5\text{V}$ , $V_{CM} = 1.5\text{V to } 4\text{V}$	●	90		dB
		$V_S = 3.3\text{V}$ , $V_{CM} = 1.15\text{V to } 2.65\text{V}$	●	85		dB
	CMRR Match (Channel-to-Channel) (Note 6)	$V_S = 5\text{V}$ , $V_{CM} = 1.5\text{V to } 4\text{V}$	●	90		dB
PSRR	Power Supply Rejection Ratio	$V_S = 3\text{V to } 10\text{V}$	●	90		dB
		PSRR Match (Channel-to-Channel) (Note 6)	●	95		dB
		Minimum Supply Voltage (Note 7)	●	3		V
$V_{\text{OL}}$	Output Voltage Swing LOW (Note 8)	No Load	●		50	mV
		$I_{\text{SINK}} = 5\text{mA}$	●		195	mV
		$V_S = 5\text{V}$ , $I_{\text{SINK}} = 15\text{mA}$	●		360	mV
		$V_S = 3.3\text{V}$ , $I_{\text{SINK}} = 10\text{mA}$	●		265	mV

**ELECTRICAL CHARACTERISTICS** The ● denotes the specifications which apply over 0°C < T<sub>A</sub> < 70°C temperature range. V<sub>S</sub> = 5V, 0V; V<sub>S</sub> = 3.3V, 0V; V<sub>CM</sub> = V<sub>OUT</sub> = half supply,  $\overline{\text{ENABLE}}$  = 0V, unless otherwise noted.

SYMBOL	PARAMETER	CONDITIONS	MIN	TYP	MAX	UNITS
V <sub>OH</sub>	Output Voltage Swing HIGH (Note 8)	No Load	●		60	mV
		I <sub>SOURCE</sub> = 5mA	●		205	mV
		V <sub>S</sub> = 5V, I <sub>SOURCE</sub> = 15mA	●		435	mV
		V <sub>S</sub> = 3.3V, I <sub>SOURCE</sub> = 10mA	●		330	mV
I <sub>SC</sub>	Short-Circuit Current	V <sub>S</sub> = 5V	●	±35		mA
		V <sub>S</sub> = 3.3V	●	±30		mA
I <sub>S</sub>	Supply Current per Amplifier Disabled Supply Current per Amplifier	$\overline{\text{ENABLE}} = V^+ - 0.25V$	●		1.39	mA
			●	1		μA
$\overline{I}_{\text{ENABLE}}$	$\overline{\text{ENABLE}}$ Pin Current	$\overline{\text{ENABLE}} = 0.3V$	●		-85	μA
V <sub>L</sub>	$\overline{\text{ENABLE}}$ Pin Input Voltage LOW		●		0.3	V
V <sub>H</sub>	$\overline{\text{ENABLE}}$ Pin Input Voltage HIGH		●	V <sup>+</sup> - 0.25		V
	Output Leakage Current	$\overline{\text{ENABLE}} = V^+ - 0.25V$ , V <sub>O</sub> = 1.5V to 3.5V	●	1		μA
t <sub>ON</sub>	Turn-On Time	$\overline{\text{ENABLE}} = 5V$ to 0V, R <sub>L</sub> = 1k, V <sub>S</sub> = 5V	●	500		ns
t <sub>OFF</sub>	Turn-Off Time	$\overline{\text{ENABLE}} = 0V$ to 5V, R <sub>L</sub> = 1k, V <sub>S</sub> = 5V	●	120		μs
SR	Slew Rate	V <sub>S</sub> = 5V, A <sub>V</sub> = -1, R <sub>L</sub> = 1k, V <sub>O</sub> = 0.5V to 4.5V	●	9		V/μs
		LT6233-10, A <sub>V</sub> = -10, R <sub>L</sub> = 1k, V <sub>O</sub> = 0.5V to 4.5V	●	75		V/μs
FPBW	Full Power Bandwidth (Note 9)	LT6233, V <sub>S</sub> = 5V, V <sub>OUT</sub> = 3V <sub>P-P</sub>	●	955		kHz

The ● denotes the specifications which apply over -40°C < T<sub>A</sub> < 85°C temperature range. V<sub>S</sub> = 5V, 0V; V<sub>S</sub> = 3.3V, 0V; V<sub>CM</sub> = V<sub>OUT</sub> = half supply,  $\overline{\text{ENABLE}} = 0V$ , unless otherwise noted. (Note 5)

SYMBOL	PARAMETER	CONDITIONS	MIN	TYP	MAX	UNITS
V <sub>OS</sub>	Input Offset Voltage	LT6233S6, LT6233S6-10	●		700	μV
		LT6234S8, LT6235GN	●		550	μV
		LT6234DD	●		650	μV
	Input Offset Voltage Match (Channel-to-Channel) (Note 6)		●		550	μV
V <sub>OS TC</sub>	Input Offset Voltage Drift (Note 10)	V <sub>CM</sub> = Half Supply	●	0.5	3	μV/°C
I <sub>B</sub>	Input Bias Current		●		4	μA
	I <sub>B</sub> Match (Channel-to-Channel) (Note 6)		●		0.4	μA
I <sub>OS</sub>	Input Offset Current		●		0.5	μA
A <sub>VOL</sub>	Large-Signal Gain	V <sub>S</sub> = 5V, V <sub>O</sub> = 0.5V to 4.5V, R <sub>L</sub> = 10k to V <sub>S</sub> /2 R <sub>L</sub> = 1k to V <sub>S</sub> /2	●	45		V/mV
			●	11		V/mV
		V <sub>S</sub> = 3.3V, V <sub>O</sub> = 0.65V to 2.65V, R <sub>L</sub> = 10k to V <sub>S</sub> /2 R <sub>L</sub> = 1k to V <sub>S</sub> /2	●	38		V/mV
			●	7		V/mV
V <sub>CM</sub>	Input Voltage Range	Guaranteed by CMRR, V <sub>S</sub> = 5V, 0V	●	1.5	4	V
		V <sub>S</sub> = 3.3V, 0V	●	1.15	2.65	V
CMRR	Common Mode Rejection Ratio	V <sub>S</sub> = 5V, V <sub>CM</sub> = 1.5V to 4V	●	90		dB
		V <sub>S</sub> = 3.3V, V <sub>CM</sub> = 1.15V to 2.65V	●	85		dB
	CMRR Match (Channel-to-Channel) (Note 6)	V <sub>S</sub> = 5V, V <sub>CM</sub> = 1.5V to 4V	●	90		dB
PSRR	Power Supply Rejection Ratio	V <sub>S</sub> = 3V to 10V	●	90		dB

# LT6233/LT6233-10/ LT6234/LT6235

## ELECTRICAL CHARACTERISTICS

The ● denotes the specifications which apply over  $-40^{\circ}\text{C} < T_A < 85^{\circ}\text{C}$  temperature range.  $V_S = 5\text{V}$ ,  $0\text{V}$ ;  $V_S = 3.3\text{V}$ ,  $0\text{V}$ ;  $V_{\text{CM}} = V_{\text{OUT}} = \text{half supply}$ ,  $\text{ENABLE} = 0\text{V}$ , unless otherwise noted. (Note 5)

SYMBOL	PARAMETER	CONDITIONS	MIN	TYP	MAX	UNITS
	PSRR Match (Channel-to-Channel) (Note 6)	$V_S = 3\text{V}$ to $10\text{V}$	●	95		dB
	Minimum Supply Voltage (Note 7)		●	3		V
$V_{\text{OL}}$	Output Voltage Swing LOW (Note 8)	No Load $I_{\text{SINK}} = 5\text{mA}$ $V_S = 5\text{V}$ , $I_{\text{SINK}} = 15\text{mA}$ $V_S = 3.3\text{V}$ , $I_{\text{SINK}} = 10\text{mA}$	● ● ● ●		50 195 370 275	mV mV mV mV
$V_{\text{OH}}$	Output Voltage Swing HIGH (Note 6)	No Load $I_{\text{SOURCE}} = 5\text{mA}$ $V_S = 5\text{V}$ , $I_{\text{SOURCE}} = 15\text{mA}$ $V_S = 3.3\text{V}$ , $I_{\text{SOURCE}} = 10\text{mA}$	● ● ● ●		60 210 445 335	mV mV mV mV
$I_{\text{SC}}$	Short-Circuit Current	$V_S = 5\text{V}$ $V_S = 3.3\text{V}$	● ●	$\pm 30$ $\pm 20$		mA mA
$I_S$	Supply Current per Amplifier Disabled Supply Current per Amplifier	$\text{ENABLE} = V^+ - 0.2\text{V}$	● ●		1.46	mA $\mu\text{A}$
$I_{\text{ENABLE}}$	ENABLE Pin Current	$\text{ENABLE} = 0.3\text{V}$	●		-100	$\mu\text{A}$
$V_L$	ENABLE Pin Input Voltage LOW		●		0.3	V
$V_H$	ENABLE Pin Input Voltage HIGH		●	$V^+ - 0.2\text{V}$		V
	Output Leakage Current	$\text{ENABLE} = V^+ - 0.2\text{V}$ , $V_O = 1.5\text{V}$ to $3.5\text{V}$	●	1		$\mu\text{A}$
$t_{\text{ON}}$	Turn-On Time	$\text{ENABLE} = 5\text{V}$ to $0\text{V}$ , $R_L = 1\text{k}$ , $V_S = 5\text{V}$	●	500		ns
$t_{\text{OFF}}$	Turn-Off Time	$\text{ENABLE} = 0\text{V}$ to $5\text{V}$ , $R_L = 1\text{k}$ , $V_S = 5\text{V}$	●	135		$\mu\text{s}$
SR	Slew Rate	$V_S = 5\text{V}$ , $A_V = -1$ , $R_L = 1\text{k}$ , $V_O = 0.5\text{V}$ to $4.5\text{V}$ LT6233-10, $A_V = -10$ , $R_L = 1\text{k}$ , $V_O = 0.5\text{V}$ to $4.5\text{V}$	● ●	8 70		V/ $\mu\text{s}$ V/ $\mu\text{s}$
FPBW	Full Power Bandwidth (Note 9)	LT6233, $V_S = 5\text{V}$ , $V_{\text{OUT}} = 3V_{\text{P-P}}$	●	848		kHz

$T_A = 25^{\circ}\text{C}$ ,  $V_S = \pm 5\text{V}$ ,  $V_{\text{CM}} = V_{\text{OUT}} = 0\text{V}$ ,  $\text{ENABLE} = 0\text{V}$ , unless otherwise noted.

SYMBOL	PARAMETER	CONDITIONS	MIN	TYP	MAX	UNITS
$V_{\text{OS}}$	Input Offset Voltage	LT6233S6, LT6233S6-10 LT6234S8, LT6235GN LT6234DD		100 50 75	500 350 450	$\mu\text{V}$ $\mu\text{V}$ $\mu\text{V}$
	Input Offset Voltage Match (Channel-to-Channel) (Note 6)			100	450	$\mu\text{V}$
$I_B$	Input Bias Current			1.5	3	$\mu\text{A}$
	$I_B$ Match (Channel-to-Channel) (Note 6)			0.04	0.3	$\mu\text{A}$
$I_{\text{OS}}$	Input Offset Current			0.04	0.3	$\mu\text{A}$
	Input Noise Voltage	0.1Hz to 10Hz		220		nV <sub>P-P</sub>
$e_n$	Input Noise Voltage Density	$f = 10\text{kHz}$		1.9	3.0	nV/ $\sqrt{\text{Hz}}$
$i_n$	Input Noise Current Density, Balanced Source Unbalanced Source	$f = 10\text{kHz}$ , $R_S = 10\text{k}$ $f = 10\text{kHz}$ , $R_S = 10\text{k}$		0.43 0.78		pA/ $\sqrt{\text{Hz}}$ pA/ $\sqrt{\text{Hz}}$

## ELECTRICAL CHARACTERISTICS

$T_A = 25^\circ\text{C}$ ,  $V_S = \pm 5\text{V}$ ,  $V_{CM} = V_{OUT} = 0\text{V}$ ,  $\overline{\text{ENABLE}} = 0\text{V}$ , unless otherwise noted.

SYMBOL	PARAMETER	CONDITIONS	MIN	TYP	MAX	UNITS
	Input Resistance	Common Mode Differential Mode		22 25		M $\Omega$ k $\Omega$
$C_{IN}$	Input Capacitance	Common Mode Differential Mode		2.1 3.7		pF pF
$A_{VOL}$	Large-Signal Gain	$V_O = \pm 4.5\text{V}$ , $R_L = 10\text{k}$ $R_L = 1\text{k}$	97 28	180 55		V/mV V/mV
$V_{CM}$	Input Voltage Range	Guaranteed by CMRR	-3		4	V
CMRR	Common Mode Rejection Ratio	$V_{CM} = -3\text{V}$ to $4\text{V}$	90	110		dB
	CMRR Match (Channel-to-Channel) (Note 6)	$V_{CM} = -3\text{V}$ to $4\text{V}$	95	120		dB
PSRR	Power Supply Rejection Ratio	$V_S = \pm 1.5\text{V}$ to $\pm 5\text{V}$	90	115		dB
	PSRR Match (Channel-to-Channel) (Note 6)	$V_S = \pm 1.5\text{V}$ to $\pm 5\text{V}$	95	115		dB
$V_{OL}$	Output Voltage Swing LOW (Note 8)	No Load $I_{SINK} = 5\text{mA}$ $I_{SINK} = 15\text{mA}$		4 75 165	40 180 320	mV mV mV
$V_{OH}$	Output Voltage Swing HIGH (Note 8)	No Load $I_{SOURCE} = 5\text{mA}$ $I_{SOURCE} = 15\text{mA}$		5 85 220	50 195 410	mV mV mV
$I_{SC}$	Short-Circuit Current		$\pm 40$	$\pm 55$		mA
$I_S$	Supply Current per Amplifier Disabled Supply Current per Amplifier	$\overline{\text{ENABLE}} = 4.65\text{V}$		1.15 0.2	1.25 10	mA $\mu\text{A}$
$I_{\overline{\text{ENABLE}}}$	$\overline{\text{ENABLE}}$ Pin Current	$\overline{\text{ENABLE}} = 0.3\text{V}$		-35	-85	$\mu\text{A}$
$V_L$	$\overline{\text{ENABLE}}$ Pin Input Voltage LOW				0.3	V
$V_H$	$\overline{\text{ENABLE}}$ Pin Input Voltage HIGH		4.65			V
	Output Leakage Current	$\overline{\text{ENABLE}} = 4.65\text{V}$ , $V_O = \pm 1\text{V}$		0.2	10	$\mu\text{A}$
$t_{ON}$	Turn-On Time	$\overline{\text{ENABLE}} = 5\text{V}$ to $0\text{V}$ , $R_L = 1\text{k}$		900		ns
$t_{OFF}$	Turn-Off Time	$\overline{\text{ENABLE}} = 0\text{V}$ to $5\text{V}$ , $R_L = 1\text{k}$		100		$\mu\text{s}$
GBW	Gain Bandwidth Product	Frequency = 1MHz LT6233-10	42 260	60 375		MHz MHz
SR	Slew Rate	$A_V = -1$ , $R_L = 1\text{k}$ , $V_O = -2\text{V}$ to $2\text{V}$ LT6233-10, $A_V = -10$ , $R_L = 1\text{k}$ , $V_O = -2\text{V}$ to $2\text{V}$	12	17 115		V/ $\mu\text{s}$ V/ $\mu\text{s}$
FPBW	Full Power Bandwidth	$V_{OUT} = 3V_{P-P}$ (Note 9) LT6233-10, $HD_2 = HD_3 \leq 1\%$	1.27	1.8 2.2		MHz MHz
$t_S$	Settling Time (LT6233, LT6234, LT6235)	0.1%, $V_{STEP} = 2\text{V}$ , $A_V = -1$ , $R_L = 1\text{k}$		170		ns

# LT6233/LT6233-10/ LT6234/LT6235

**ELECTRICAL CHARACTERISTICS** The ● denotes the specifications which apply over  $0^{\circ}\text{C} < T_A < 70^{\circ}\text{C}$  temperature range.  $V_S = \pm 5\text{V}$ ,  $V_{\text{CM}} = V_{\text{OUT}} = 0\text{V}$ ,  $\overline{\text{ENABLE}} = 0\text{V}$ , unless otherwise noted.

SYMBOL	PARAMETER	CONDITIONS	MIN	TYP	MAX	UNITS
$V_{\text{OS}}$	Input Offset Voltage	LT6233S6, LT6233S6-10	●		600	$\mu\text{V}$
		LT6234S8, LT6235GN	●		450	$\mu\text{V}$
		LT6234DD	●		550	$\mu\text{V}$
	Input Offset Voltage Match (Channel-to-Channel) (Note 6)		●		500	$\mu\text{V}$
$V_{\text{OS TC}}$	Input Offset Voltage Drift (Note 10)		●	0.5	3	$\mu\text{V}/^{\circ}\text{C}$
$I_{\text{B}}$	Input Bias Current		●		3.5	$\mu\text{A}$
	$I_{\text{B}}$ Match (Channel-to-Channel) (Note 6)		●		0.4	$\mu\text{A}$
$I_{\text{OS}}$	Input Offset Current		●		0.4	$\mu\text{A}$
$A_{\text{VOL}}$	Large-Signal Gain	$V_{\text{O}} = \pm 4.5\text{V}$ , $R_{\text{L}} = 10\text{k}$	●	75		$\text{V}/\text{mV}$
		$R_{\text{L}} = 1\text{k}$	●	22		$\text{V}/\text{mV}$
$V_{\text{CM}}$	Input Voltage Range	Guaranteed by CMRR	●	-3	4	V
CMRR	Common Mode Rejection Ratio	$V_{\text{CM}} = -3\text{V}$ to $4\text{V}$	●	90		dB
	CMRR Match (Channel-to-Channel) (Note 6)	$V_{\text{CM}} = -3\text{V}$ to $4\text{V}$	●	95		dB
PSRR	Power Supply Rejection Ratio	$V_{\text{S}} = \pm 1.5\text{V}$ to $\pm 5\text{V}$	●	90		dB
	PSRR Match (Channel-to-Channel) (Note 6)	$V_{\text{S}} = \pm 1.5\text{V}$ to $\pm 5\text{V}$	●	95		dB
$V_{\text{OL}}$	Output Voltage Swing LOW (Note 8)	No Load	●		50	mV
		$I_{\text{SINK}} = 5\text{mA}$	●		195	mV
		$I_{\text{SINK}} = 15\text{mA}$	●		360	mV
$V_{\text{OH}}$	Output Voltage Swing HIGH (Note 8)	No Load	●		60	mV
		$I_{\text{SOURCE}} = 5\text{mA}$	●		205	mV
		$I_{\text{SOURCE}} = 15\text{mA}$	●		435	mV
$I_{\text{SC}}$	Short-Circuit Current		●	$\pm 35$		mA
$I_{\text{S}}$	Supply Current per Amplifier		●		1.53	mA
	Disabled Supply Current per Amplifier	$\overline{\text{ENABLE}} = 4.75\text{V}$	●	1		$\mu\text{A}$
$I_{\overline{\text{ENABLE}}}$	$\overline{\text{ENABLE}}$ Pin Current	$\overline{\text{ENABLE}} = 0.3\text{V}$	●		-95	$\mu\text{A}$
$V_{\text{L}}$	$\overline{\text{ENABLE}}$ Pin Input Voltage LOW		●		0.3	V
$V_{\text{H}}$	$\overline{\text{ENABLE}}$ Pin Input Voltage HIGH		●	4.75		V
	Output Leakage Current	$\overline{\text{ENABLE}} = 4.75\text{V}$ , $V_{\text{O}} = \pm 1\text{V}$	●	1		$\mu\text{A}$
$t_{\text{ON}}$	Turn-On Time	$\overline{\text{ENABLE}} = 5\text{V}$ to $0\text{V}$ , $R_{\text{L}} = 1\text{k}$	●	900		ns
$t_{\text{OFF}}$	Turn-Off Time	$\overline{\text{ENABLE}} = 0\text{V}$ to $5\text{V}$ , $R_{\text{L}} = 1\text{k}$	●	150		$\mu\text{s}$
SR	Slew Rate	$A_{\text{V}} = -1$ , $R_{\text{L}} = 1\text{k}$ , $V_{\text{O}} = -2\text{V}$ to $2\text{V}$	●	11		$\text{V}/\mu\text{s}$
		LT6233-10, $A_{\text{V}} = -10$ , $R_{\text{L}} = 1\text{k}$ , $V_{\text{O}} = -2\text{V}$ to $2\text{V}$	●	105		$\text{V}/\mu\text{s}$
FPBW	Full Power Bandwidth (Note 9)	LT6233, $V_{\text{OUT}} = 3\text{V}_{\text{P-P}}$	●	1.16		MHz



**ELECTRICAL CHARACTERISTICS** The ● denotes the specifications which apply over  $-40^{\circ}\text{C} < T_A < 85^{\circ}\text{C}$  temperature range.  $V_S = \pm 5\text{V}$ ,  $V_{\text{CM}} = V_{\text{OUT}} = 0\text{V}$ ,  $\overline{\text{ENABLE}} = 0\text{V}$ , unless otherwise noted. (Note 5)

SYMBOL	PARAMETER	CONDITIONS	MIN	TYP	MAX	UNITS
$V_{\text{OS}}$	Input Offset Voltage	LT6233S6, LT6233S6-10	●		700	$\mu\text{V}$
		LT6234S8, LT6235GN	●		550	$\mu\text{V}$
		LT6234DD	●		650	$\mu\text{V}$
	Input Offset Voltage Match (Channel-to-Channel) (Note 6)		●		550	$\mu\text{V}$
$V_{\text{OS TC}}$	Input Offset Voltage Drift (Note 10)		●	0.5	3	$\mu\text{V}/^{\circ}\text{C}$
$I_{\text{B}}$	Input Bias Current		●		4	$\mu\text{A}$
	$I_{\text{B}}$ Match (Channel-to-Channel) (Note 6)		●		0.4	$\mu\text{A}$
$I_{\text{OS}}$	Input Offset Current		●		0.5	$\mu\text{A}$
$A_{\text{VOL}}$	Large-Signal Gain	$V_0 = \pm 4.5\text{V}$ , $R_{\text{L}} = 10\text{k}$	●	68		V/mV
		$R_{\text{L}} = 1\text{k}$	●	20		V/mV
$V_{\text{CM}}$	Input Voltage Range	Guaranteed by CMRR	●	-3	4	V
CMRR	Common Mode Rejection Ratio	$V_{\text{CM}} = -3\text{V}$ to $4\text{V}$	●	90		dB
	CMRR Match (Channel-to-Channel) (Note 6)	$V_{\text{CM}} = -3\text{V}$ to $4\text{V}$	●	90		dB
PSRR	Power Supply Rejection Ratio	$V_S = \pm 1.5\text{V}$ to $\pm 5\text{V}$	●	90		dB
	PSRR Match (Channel-to-Channel) (Note 6)	$V_S = \pm 1.5\text{V}$ to $\pm 5\text{V}$	●	95		dB
$V_{\text{OL}}$	Output Voltage Swing LOW (Note 8)	No Load	●		50	mV
		$I_{\text{SINK}} = 5\text{mA}$	●		195	mV
		$I_{\text{SINK}} = 15\text{mA}$	●		370	mV
$V_{\text{OH}}$	Output Voltage Swing HIGH (Note 8)	No Load	●		70	mV
		$I_{\text{SOURCE}} = 5\text{mA}$	●		210	mV
		$I_{\text{SOURCE}} = 15\text{mA}$	●		445	mV
$I_{\text{SC}}$	Short-Circuit Current		●	$\pm 30$		mA
$I_{\text{S}}$	Supply Current per Amplifier		●		1.61	mA
	Disabled Supply Current per Amplifier	$\overline{\text{ENABLE}} = 4.8\text{V}$	●	1		$\mu\text{A}$
$I_{\overline{\text{ENABLE}}}$	$\overline{\text{ENABLE}}$ Pin Current	$\overline{\text{ENABLE}} = 0.3\text{V}$	●		-110	$\mu\text{A}$
$V_{\text{L}}$	$\overline{\text{ENABLE}}$ Pin Input Voltage LOW		●		0.3	V
$V_{\text{H}}$	$\overline{\text{ENABLE}}$ Pin Input Voltage HIGH		●	4.8		V
	Output Leakage Current	$\overline{\text{ENABLE}} = 4.8\text{V}$ , $V_0 = \pm 1\text{V}$	●	1		$\mu\text{A}$
$t_{\text{ON}}$	Turn-On Time	$\overline{\text{ENABLE}} = 5\text{V}$ to $0\text{V}$ , $R_{\text{L}} = 1\text{k}$	●	900		ns
$t_{\text{OFF}}$	Turn-Off Time	$\overline{\text{ENABLE}} = 0\text{V}$ to $5\text{V}$ , $R_{\text{L}} = 1\text{k}$	●	160		$\mu\text{s}$
SR	Slew Rate	$A_{\text{V}} = -1$ , $R_{\text{L}} = 1\text{k}$ , $V_0 = -2\text{V}$ to $2\text{V}$	●	10		V/ $\mu\text{s}$
		LT6233-10, $A_{\text{V}} = -10$ , $R_{\text{L}} = 1\text{k}$ , $V_0 = -2\text{V}$ to $2\text{V}$	●	95		V/ $\mu\text{s}$
FPBW	Full Power Bandwidth (Note 9)	LT6233, $V_{\text{OUT}} = 3\text{V}_{\text{P-P}}$	●	1.06		MHz

## ELECTRICAL CHARACTERISTICS

**Note 1:** Absolute maximum ratings are those values beyond which the life of the device may be impaired.

**Note 2:** Inputs are protected by back-to-back diodes. If the differential input voltage exceeds 0.7V, the input current must be limited to less than 40mA.

**Note 3:** A heat sink may be required to keep the junction temperature below the absolute maximum rating when the output is shorted indefinitely.

**Note 4:** The LT6233C/LT6233I, the LT6234C/LT6234I, and LT6235C/LT6235I are guaranteed functional over the temperature range of  $-40^{\circ}\text{C}$  and  $85^{\circ}\text{C}$ .

**Note 5:** The LT6233C/LT6234C/LT6235C are guaranteed to meet specified performance from  $0^{\circ}\text{C}$  to  $70^{\circ}\text{C}$ . The LT6233C/LT6234C/LT6235C are designed, characterized and expected to meet specified performance from  $-40^{\circ}\text{C}$  to  $85^{\circ}\text{C}$ , but are not tested or QA sampled at these temperatures.

The LT6233I/LT6234I/LT6235I are guaranteed to meet specified performance from  $-40^{\circ}\text{C}$  to  $85^{\circ}\text{C}$ .

**Note 6:** Matching parameters are the difference between the two amplifiers A and D and between B and C of the LT6235; between the two amplifiers of the LT6234. CMRR and PSRR match are defined as follows: CMRR and PSRR are measured in  $\mu\text{V}/\text{V}$  on the matched amplifiers. The difference is calculated between the matching sides in  $\mu\text{V}/\text{V}$ . The result is converted to dB.

**Note 7:** Minimum supply voltage is guaranteed by power supply rejection ratio test.

**Note 8:** Output voltage swings are measured between the output and power supply rails.

**Note 9:** Full-power bandwidth is calculated from the slew rate:  

$$\text{FPBW} = \text{SR}/2\pi V_p$$

**Note 10:** This parameter is not 100% tested.

## TYPICAL PERFORMANCE CHARACTERISTICS

(LT6233/LT6234/LT6235)

**$V_{OS}$  Distribution**

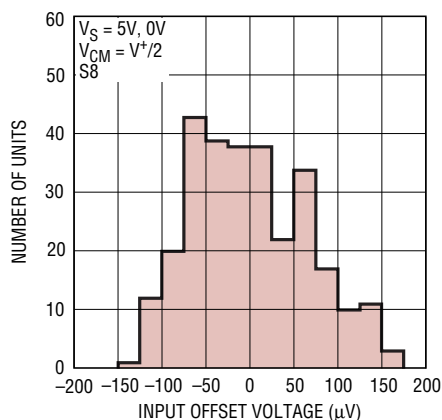

623345 G01

**Supply Current vs Supply Voltage (Per Amplifier)**

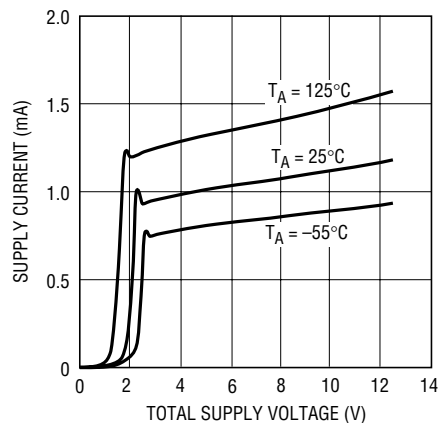

623345 G02

**Offset Voltage vs Input Common Mode Voltage**

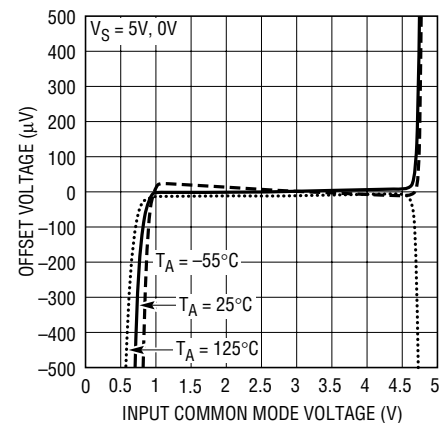

623345 G03

**Input Bias Current vs Common Mode Voltage**

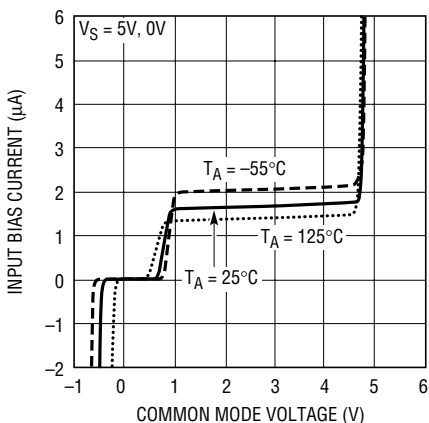

623345 G04

**Input Bias Current vs Temperature**

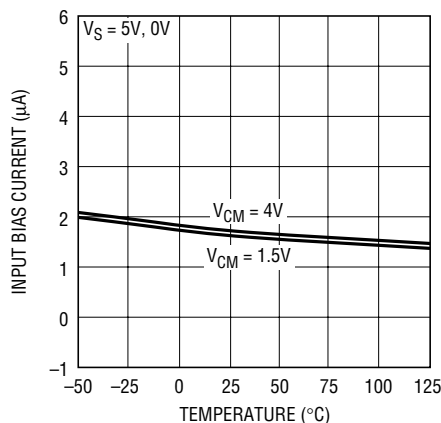

623345 G05

**Output Saturation Voltage vs Load Current (Output Low)**

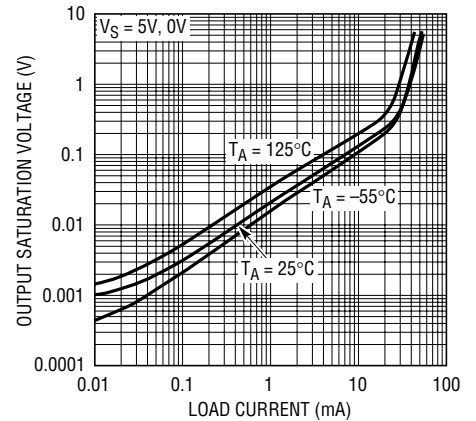

623345 G06

623345f

# TYPICAL PERFORMANCE CHARACTERISTICS

(LT6233/LT6234/LT6235)

**Output Saturation Voltage vs Load Current (Output High)**

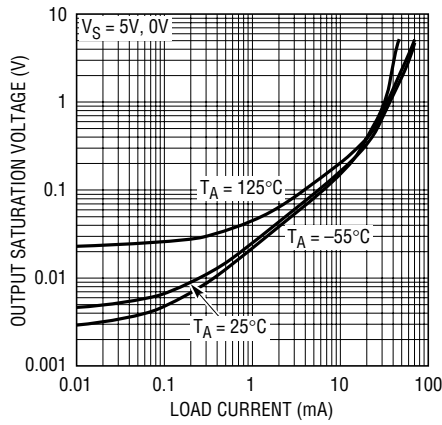

623345 G07

**Minimum Supply Voltage**

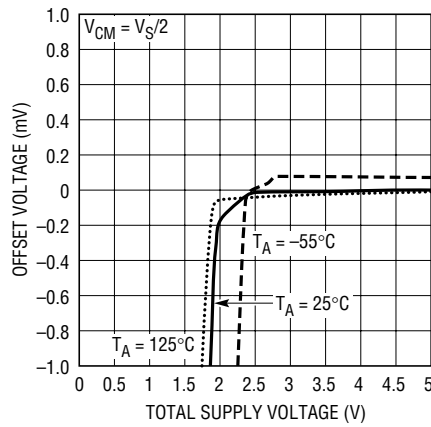

623345 G08

**Output Short Circuit Current vs Power Supply Voltage**

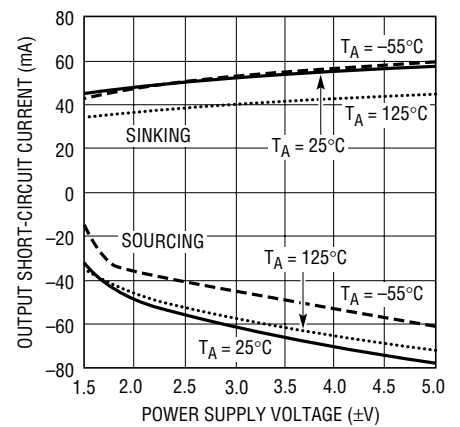

623345 G09

**Open Loop Gain**

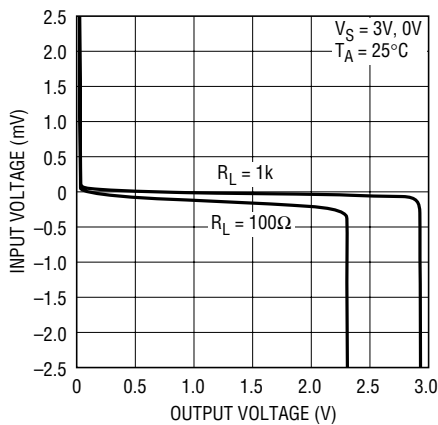

623345 G10

**Open Loop Gain**

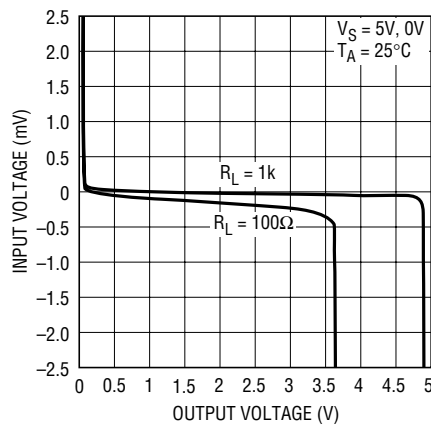

623345 G11

**Open Loop Gain**

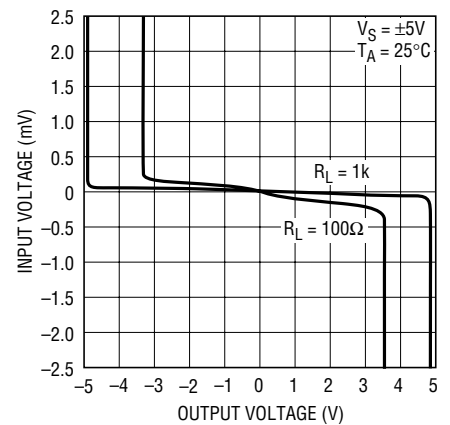

623345 G12

**Offset Voltage vs Output Current**

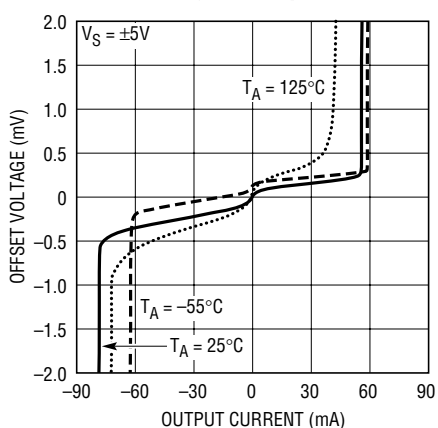

623345 G13

**Warm-Up Drift vs Time**

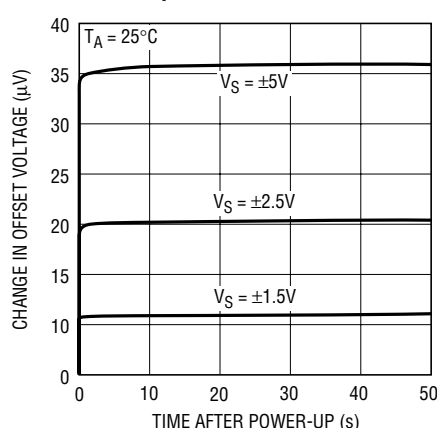

623345 G14

**Total Noise vs Total Source Resistance**

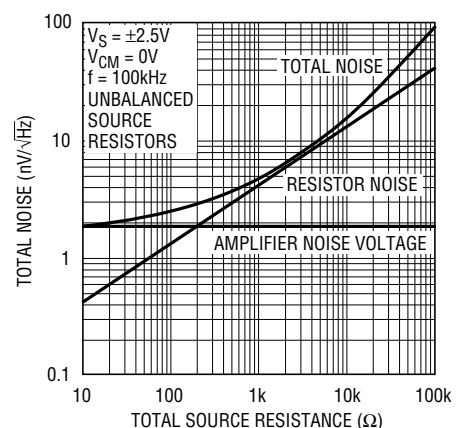

623345 G15

# TYPICAL PERFORMANCE CHARACTERISTICS

(LT6233/LT6234/LT6235)

**Noise Voltage and Unbalanced Noise Current vs Frequency**

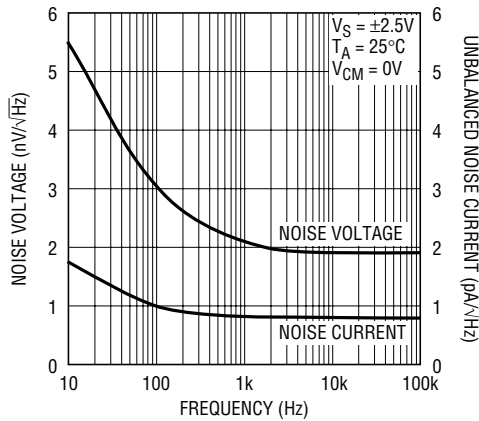

623345 G16

**0.1Hz to 10Hz Output Voltage Noise**

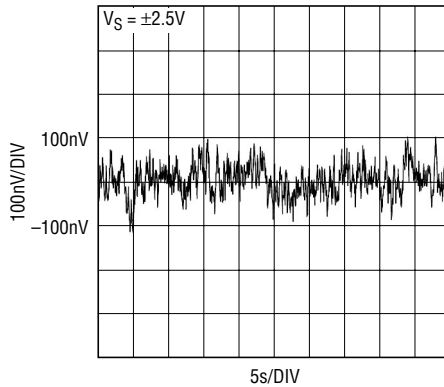

623345 G17

**Gain Bandwidth and Phase Margin vs Temperature**

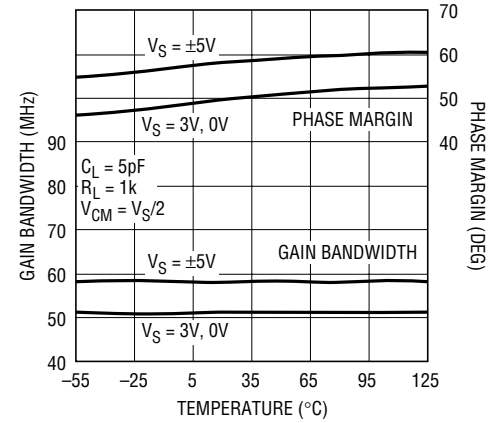

623345 G18

**Open Loop Gain vs Frequency**

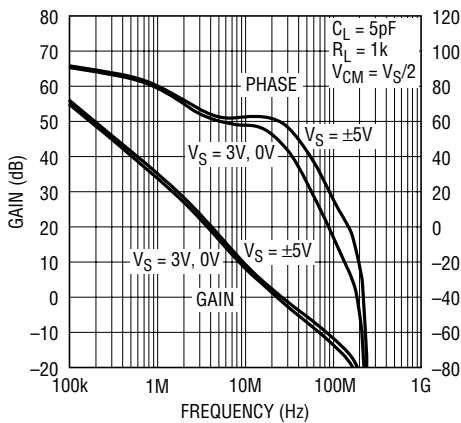

623345 G19

**Gain Bandwidth and Phase Margin vs Supply Voltage**

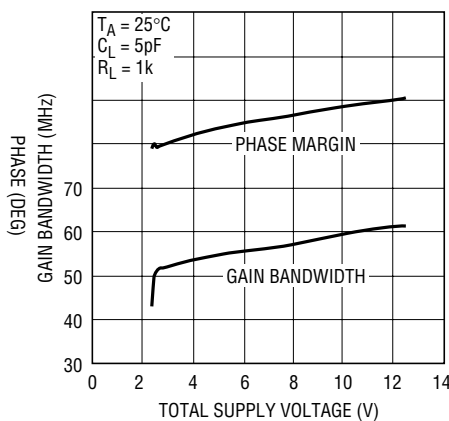

623345 G20

**Slew Rate vs Temperature**

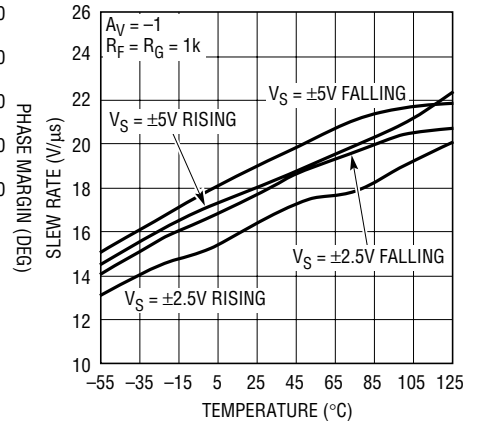

623345 G21

**Output Impedance vs Frequency**

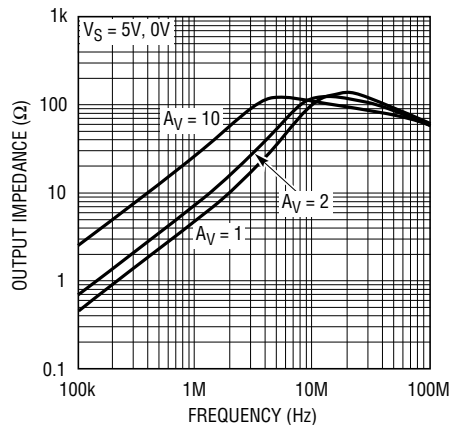

623345 G22

**Common Mode Rejection Ratio vs Frequency**

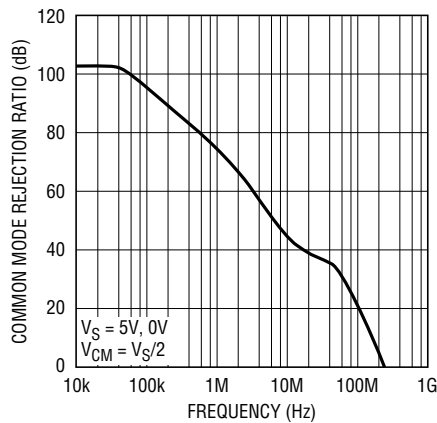

623345 G23

**Channel Separation vs Frequency**

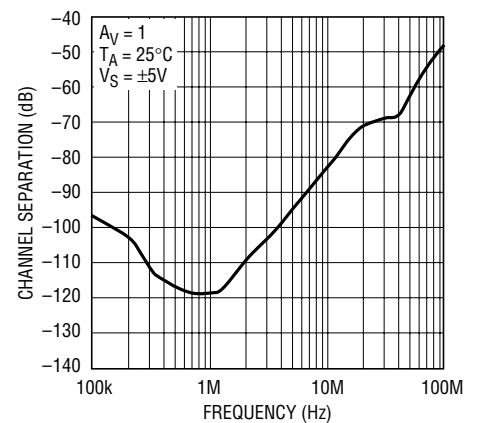

623345 G24

623345f

# TYPICAL PERFORMANCE CHARACTERISTICS

(LT6233/LT6234/LT6235)

**Power Supply Rejection Ratio vs Frequency**

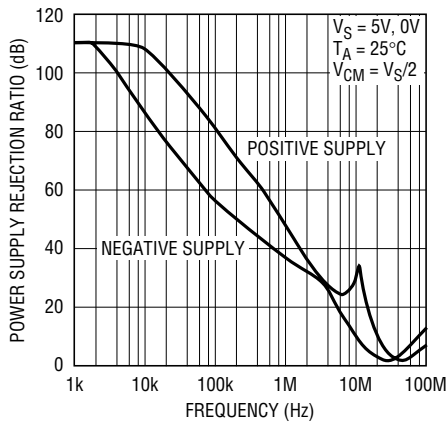

623345 G25

**Series Output Resistance and Overshoot vs Capacitive Load**

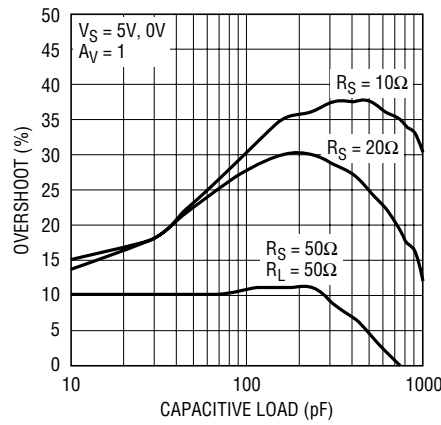

623345 G26

**Series Output Resistance and Overshoot vs Capacitive Load**

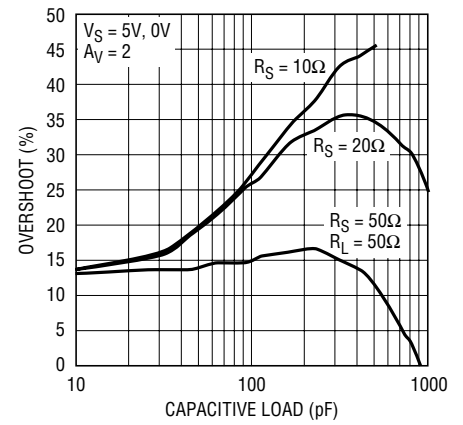

623345 G27

**Settling Time vs Output Step (Non-Inverting)**

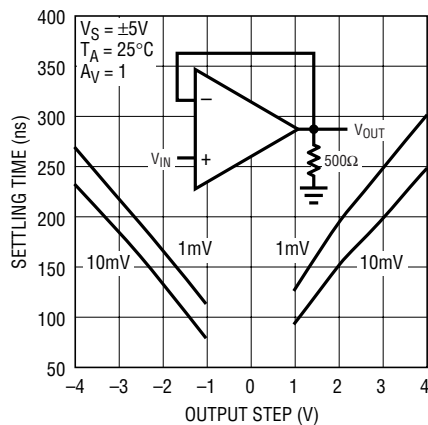

623345 G28

**Settling Time vs Output Step (Inverting)**

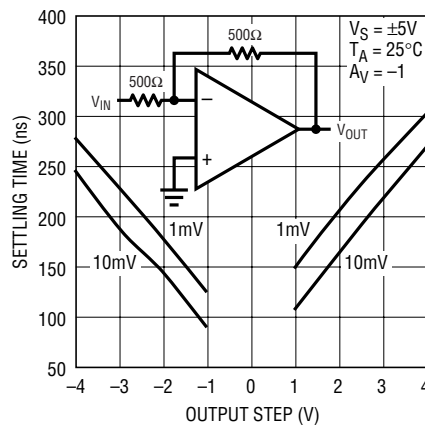

623345 G29

**Maximum Undistorted Output Signal vs Frequency**

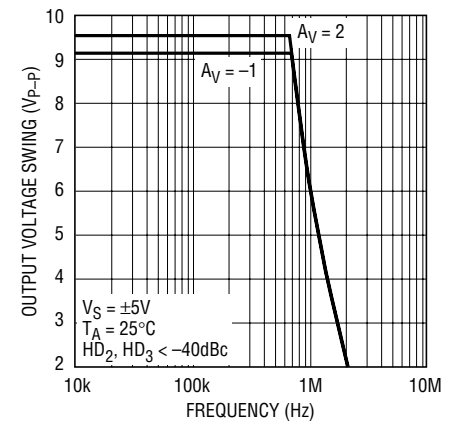

623345 G30

**Distortion vs Frequency**

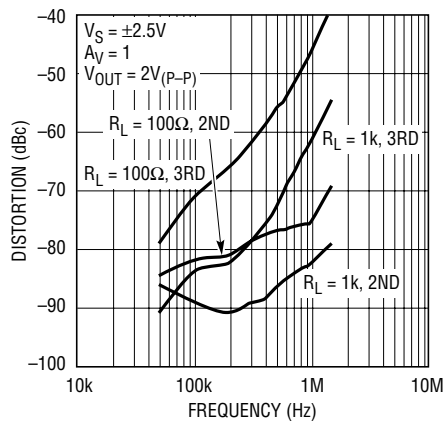

623345 G31

**Distortion vs Frequency**

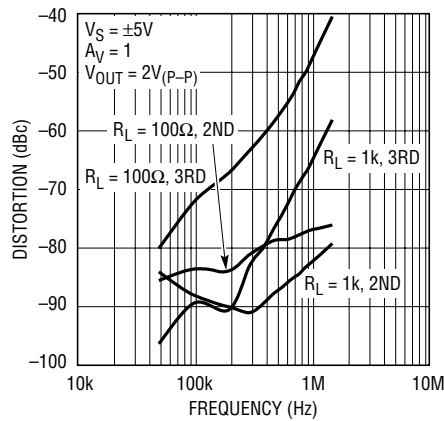

623345 G32

**Distortion vs Frequency**

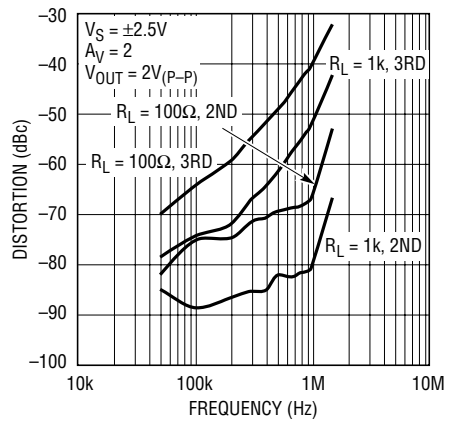

623345 G33

# TYPICAL PERFORMANCE CHARACTERISTICS

(LT6233/LT6234/LT6235)

**Distortion vs Frequency**

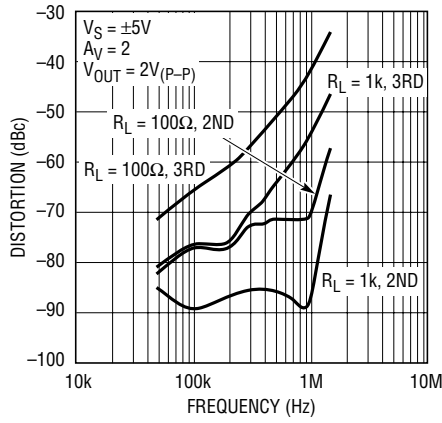

623345 G34

**Large Signal Response**

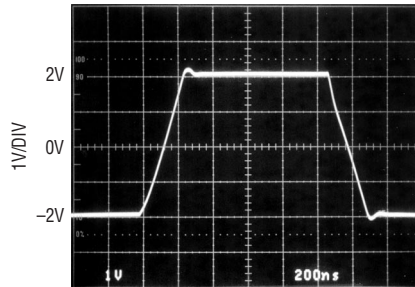

623345 G35

**Small Signal Response**

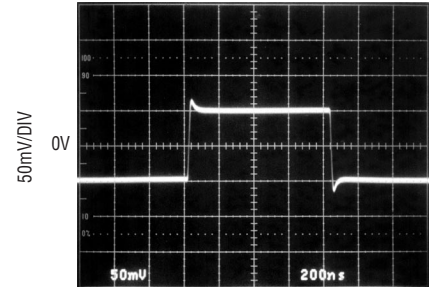

623345 G36

**Large Signal Response**

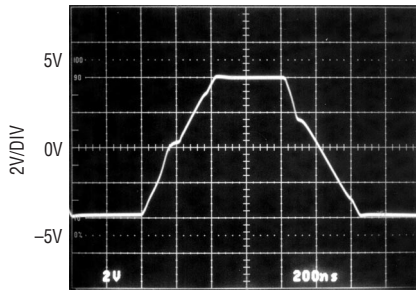

623345 G37

**Output Overdrive Recovery**

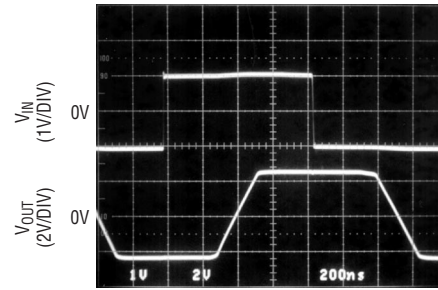

623345 G38

## (LT6233) $\overline{ENABLE}$ Characteristics

**Supply Current vs  $\overline{ENABLE}$  Pin Voltage**

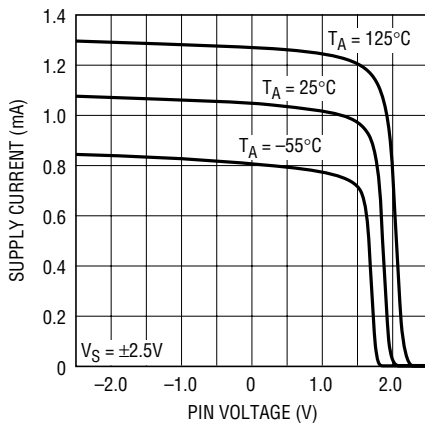

623345 G39

**$\overline{ENABLE}$  Pin Current vs  $\overline{ENABLE}$  Pin Voltage**

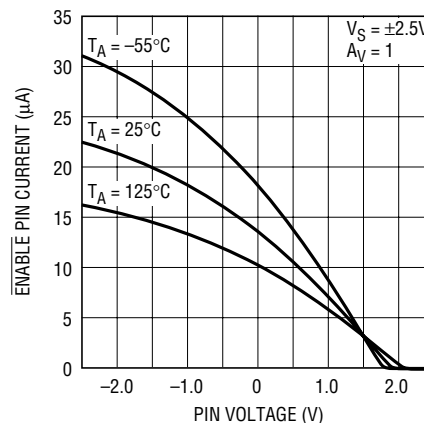

623345 G40

**$\overline{ENABLE}$  Pin Response Time**

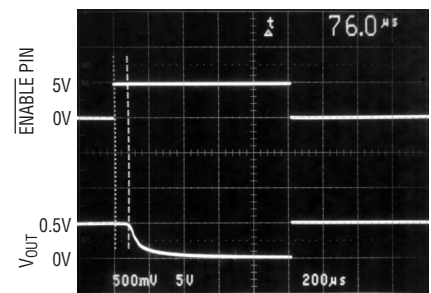

623345 G41

623345f

# TYPICAL PERFORMANCE CHARACTERISTICS

(LT6233-10)

**Gain Bandwidth and Phase Margin vs Temperature**

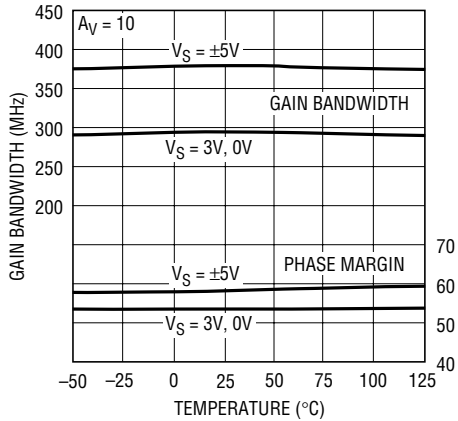

623345 G42

**Slew Rate vs Temperature**

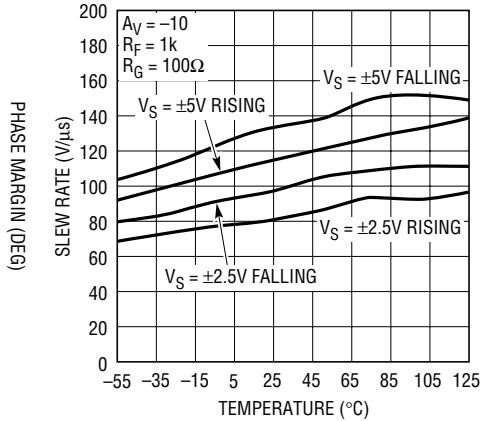

623345 G43

**Series Output Resistance and Overshoot vs Capacitive Load**

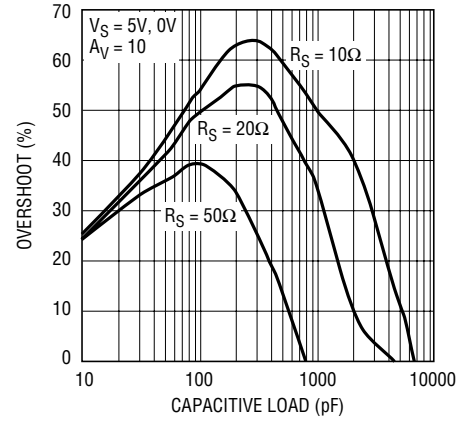

623345 G44

**Open Loop Gain vs Frequency**

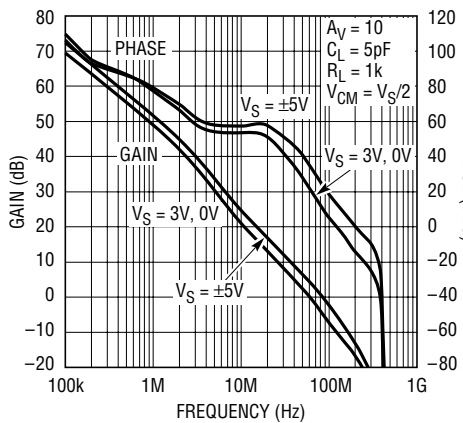

623345 G45

**Gain Bandwidth and Phase Margin vs Supply Voltage**

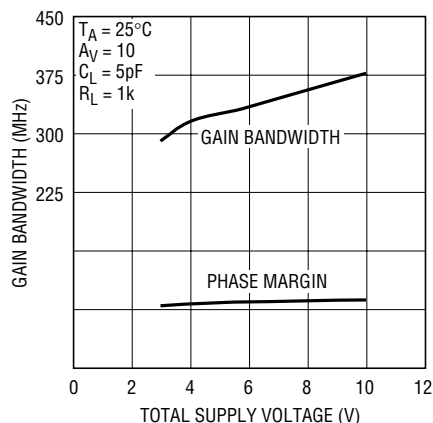

623345 G46

**Gain Bandwidth vs Resistor Load**

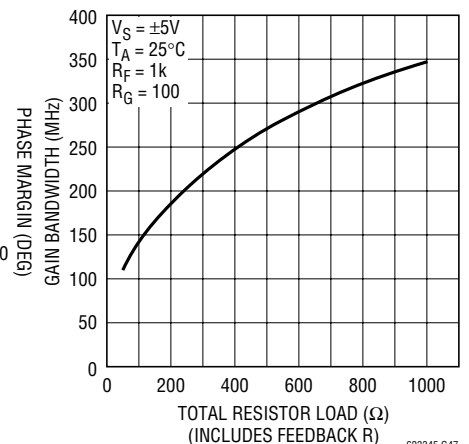

623345 G47

**Common Mode Rejection Ratio vs Frequency**

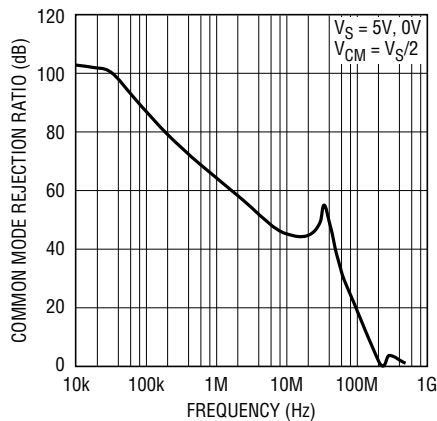

623345 G48

**Maximum Undistorted Output vs Frequency**

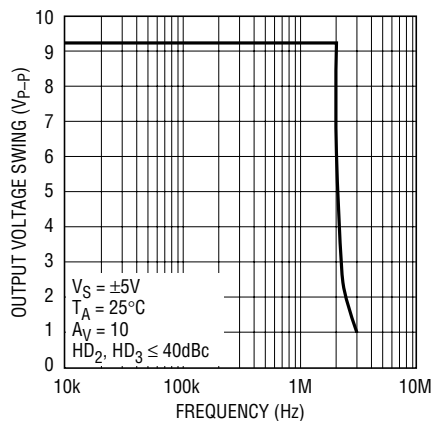

623345 G49

**2<sup>nd</sup> and 3<sup>rd</sup> Harmonic Distortion vs Frequency**

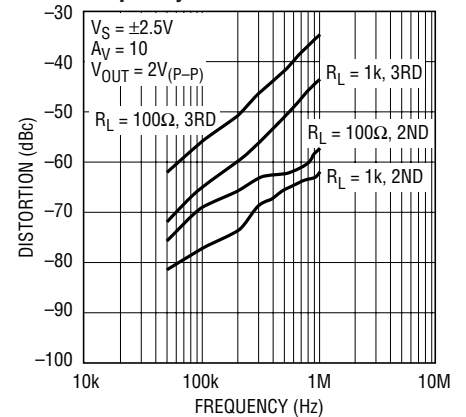

623345 G50



## TYPICAL PERFORMANCE CHARACTERISTICS

(LT6233-10)

2<sup>nd</sup> and 3<sup>rd</sup> Harmonic Distortion vs Frequency

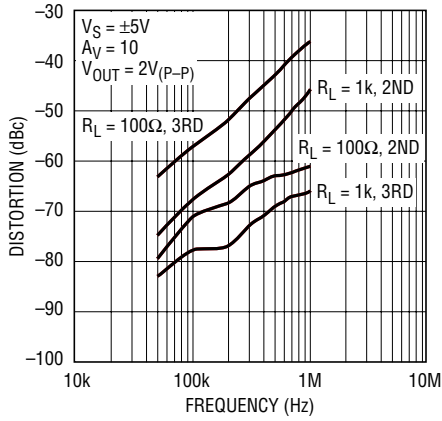

Large Signal Response

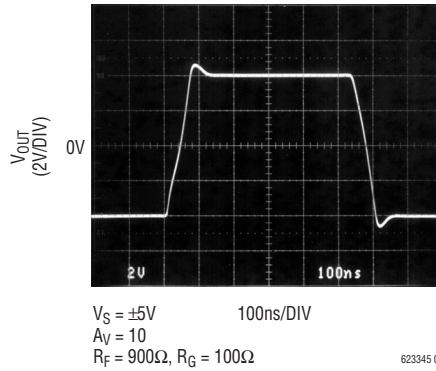

Output-Overload Recovery

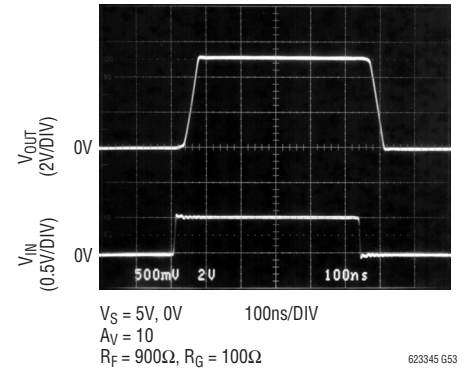

Small Signal Response

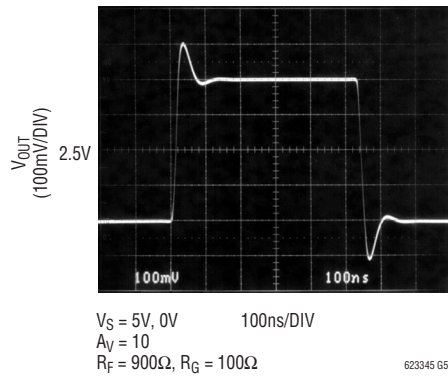

Input Referred High Frequency Noise Spectrum

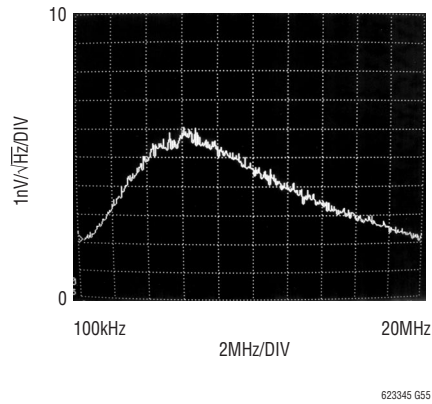



## APPLICATIONS INFORMATION

### Amplifier Characteristics

Figure 1 is a simplified schematic of the LT6233/LT6234/LT6235, which has a pair of low noise input transistors Q1 and Q2. A simple current mirror Q3/Q4 converts the differential signal to a single-ended output, and these transistors are degenerated to reduce their contribution to the overall noise.

Capacitor C1 reduces the unity cross frequency and improves the frequency stability without degrading the gain bandwidth of the amplifier. Capacitor  $C_M$  sets the overall amplifier gain bandwidth. The differential drive generator supplies current to transistors Q5 and Q6 that swing the output from rail-to-rail.

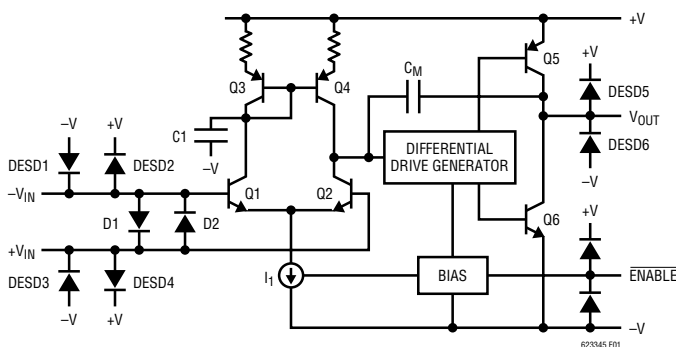

Figure 1. Simplified Schematic

### Input Protection

There are back-to-back diodes, D1 and D2 across the + and – inputs of these amplifiers to limit the differential input voltage to  $\pm 0.7V$ . The inputs of the LT6233/LT6234/LT6235 do not have internal resistors in series with the input transistors. This technique is often used to protect the input devices from over voltage that causes excessive current to flow. The addition of these resistors would significantly degrade the low noise voltage of these amplifiers. For instance, a  $100\Omega$  resistor in series with each input would generate  $1.8nV/\sqrt{Hz}$  of noise, and the total amplifier noise voltage would rise from  $1.9nV/\sqrt{Hz}$  to  $2.6nV/\sqrt{Hz}$ . Once the input differential voltage exceeds  $\pm 0.7V$ , steady state current conducted through the protection diodes should be limited to  $\pm 40mA$ . This implies  $25\Omega$  of protection resistance is necessary per volt of overdrive beyond  $\pm 0.7V$ . These input diodes are rugged enough to

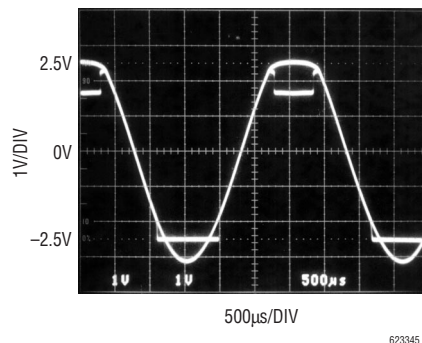

Figure 2.  $V_S = \pm 2.5V$ ,  $A_V = 1$  with Large Overdrive

handle transient currents due to amplifier slew rate overdrive and clipping without protection resistors.

The photo of Figure 2 shows the output response to an input overdrive with the amplifier connected as a voltage follower. With the input signal low, current source  $I_1$  saturates and the differential drive generator drives Q6 into saturation so the output voltage swings all the way to  $V^-$ . The input can swing positive until transistor Q2 saturates into current mirror Q3/Q4. When saturation occurs, the output tries to phase invert, but diode D2 conducts current from the signal source to the output through the feedback connection. The output is clamped a diode drop below the input. In this photo, the input signal generator is limiting at about 20mA.

With the amplifier connected in a gain of  $A_V \geq 2$ , the output can invert with very heavy overdrive. To avoid this inversion, limit the input overdrive to 0.5V beyond the power supply rails.

### ESD

The LT6233/LT6234/LT6235 have reverse-biased ESD protection diodes on all inputs and outputs as shown in Figure 1. If these pins are forced beyond either supply, unlimited current will flow through these diodes. If the current is transient and limited to one hundred milliamps or less, no damage to the device will occur.

### Noise

The noise voltage of the LT6233/LT6234/LT6235 is equivalent to that of a  $225\Omega$  resistor, and for the lowest possible noise it is desirable to keep the source and feedback resistance at or below this value, i.e.  $R_S + R_G || R_{FB} \leq 225\Omega$ .

623345f

## APPLICATIONS INFORMATION

With  $R_S + R_G || R_{FB} = 225\Omega$  the total noise of the amplifier is:

$$e_N = \sqrt{(1.9\text{nV})^2 + (1.9\text{nV})^2} = 2.69\text{nV}/\sqrt{\text{Hz}}$$

Below this resistance value, the amplifier dominates the noise, but in the region between  $225\Omega$  and about  $30\text{k}$ , the noise is dominated by the resistor thermal noise. As the total resistance is further increased beyond  $30\text{k}$ , the amplifier noise current multiplied by the total resistance eventually dominates the noise.

The product of  $e_N \cdot \sqrt{I_{\text{SUPPLY}}}$  is an interesting way to gauge low noise amplifiers. Most low noise amplifiers with low  $e_N$  have high  $I_{\text{SUPPLY}}$  current. In applications that require low noise voltage with the lowest possible supply current, this product can prove to be enlightening. The LT6233/LT6234/LT6235 have an  $e_N \cdot \sqrt{I_{\text{SUPPLY}}}$  product of only 2.1 per amplifier, yet it is common to see amplifiers with similar noise specifications to have  $e_N \cdot \sqrt{I_{\text{SUPPLY}}}$  as high as 13.5.

For a complete discussion of amplifier noise, see the LT1028 data sheet.

### Enable Pin

The LT6233 and LT6233-10 include an  $\overline{\text{ENABLE}}$  pin that shuts down the amplifier to  $10\mu\text{A}$  maximum supply current. The  $\overline{\text{ENABLE}}$  pin must be driven high to within  $0.35\text{V}$  of  $V^+$  to shut down the supply current. This can be accomplished with simple gate logic; however care must be taken if the logic and the LT6233 operate from different supplies. If this is the case, then open drain logic can be used with a pull-up resistor to ensure that the amplifier remains off. See Typical Characteristic Curves.

The output leakage current when disabled is very low; however, current can flow into the input protection diodes D1 and D2 if the output voltage exceeds the input voltage by a diode drop.

## APPLICATIONS INFORMATION

### Single Supply, Low Noise, Low Power, Bandpass Filter with Gain = 10

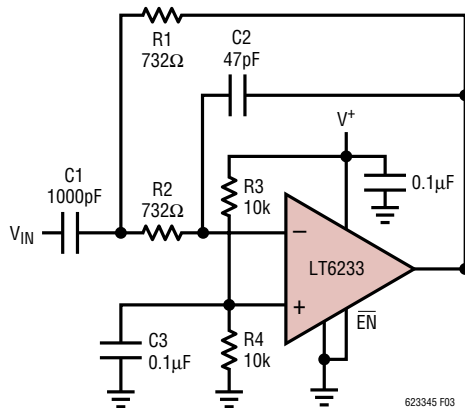

$$f_0 = \frac{1}{2\pi RC} = 1\text{MHz}$$

$$C = \sqrt{C_1 C_2}, R = R_1 = R_2$$

$$f_0 = \left(\frac{732\Omega}{R}\right)\text{MHz, MAXIMUM } f_0 = 1\text{MHz}$$

$$f_{-3\text{dB}} = \frac{f_0}{2.5}$$

$$A_V = 20\text{dB at } f_0$$

$$\bar{E}_N = 6\mu\text{VRMS INPUT REFERRED}$$

$$I_S = 1.5\text{mA FOR } V^+ = 5\text{V}$$

623345 F03

Frequency Response Plot of  
Bandpass Filter

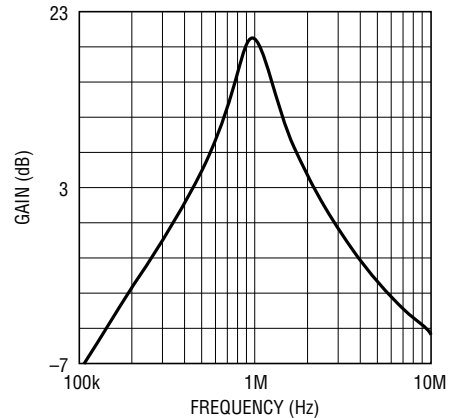

623345 F04

### Low Power, Low Noise, Single Supply, Instrumentation Amplifier with Gain = 100

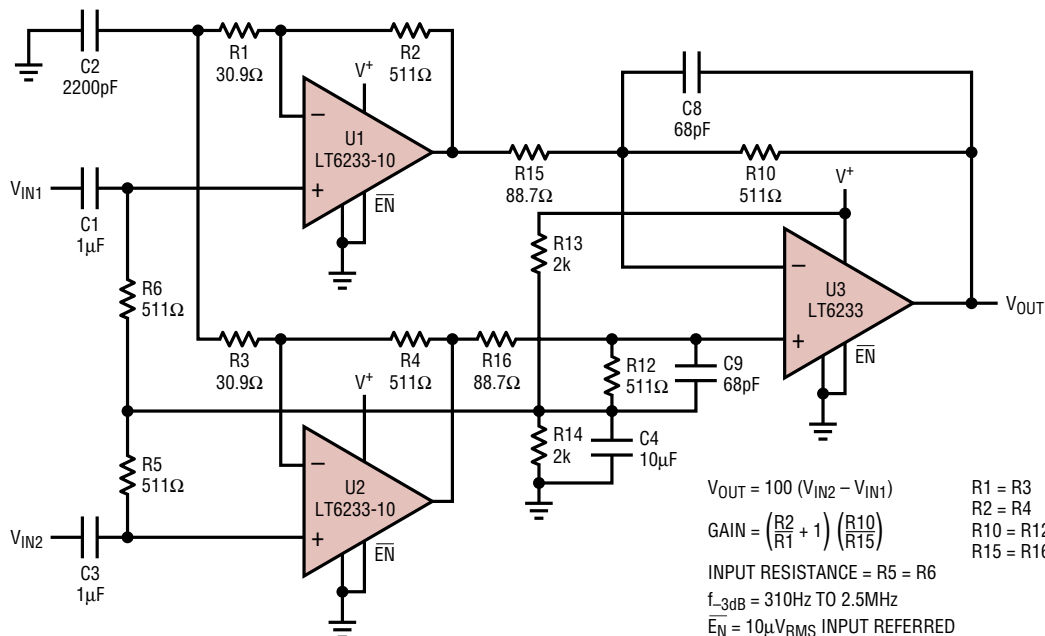

$$V_{OUT} = 100 (V_{IN2} - V_{IN1})$$

$$\text{GAIN} = \left(\frac{R_2}{R_1} + 1\right) \left(\frac{R_{10}}{R_{15}}\right)$$

$$\text{INPUT RESISTANCE} = R_5 = R_6$$

$$f_{-3\text{dB}} = 310\text{Hz TO } 2.5\text{MHz}$$

$$\bar{E}_N = 10\mu\text{VRMS INPUT REFERRED}$$

$$I_S = 4.7\text{mA FOR } V_S = 5\text{V, } 0\text{V}$$

$$R_1 = R_3$$

$$R_2 = R_4$$

$$R_{10} = R_{12}$$

$$R_{15} = R_{16}$$

623345 F05

## PACKAGE DESCRIPTION

**S6 Package**  
**6-Lead Plastic TSOT-23**  
 (Reference LTC DWG # 05-08-1636)

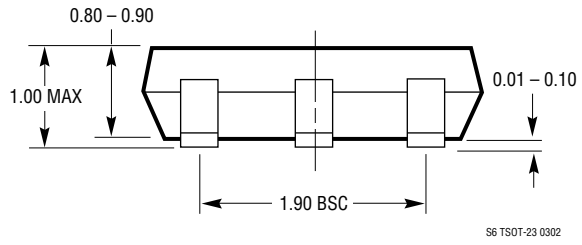
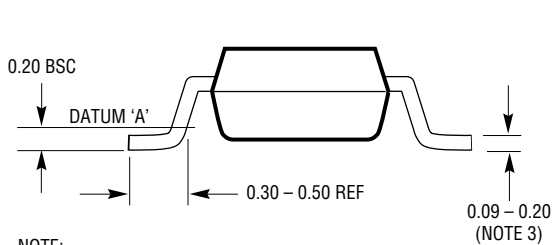
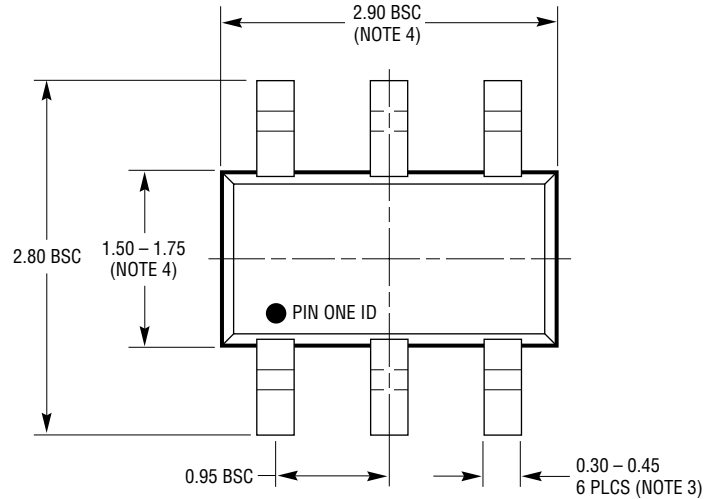
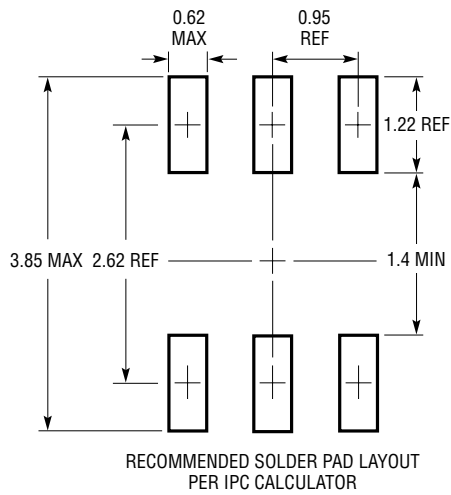

- NOTE:
1. DIMENSIONS ARE IN MILLIMETERS
  2. DRAWING NOT TO SCALE
  3. DIMENSIONS ARE INCLUSIVE OF PLATING
  4. DIMENSIONS ARE EXCLUSIVE OF MOLD FLASH AND METAL BURR
  5. MOLD FLASH SHALL NOT EXCEED 0.254mm
  6. JEDEC PACKAGE REFERENCE IS MO-193

## PACKAGE DESCRIPTION

**DD Package**  
**8-Lead Plastic DFN (3mm × 3mm)**  
(Reference LTC DWG # 05-08-1698)

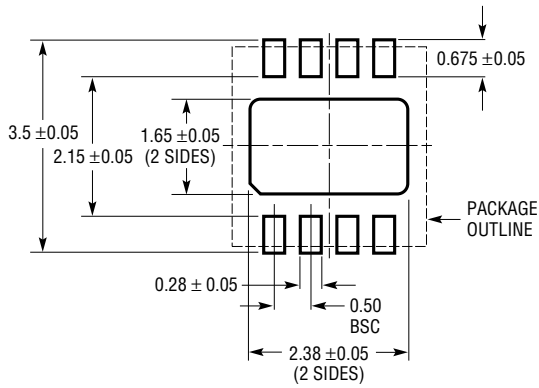

RECOMMENDED SOLDER PAD PITCH AND DIMENSIONS

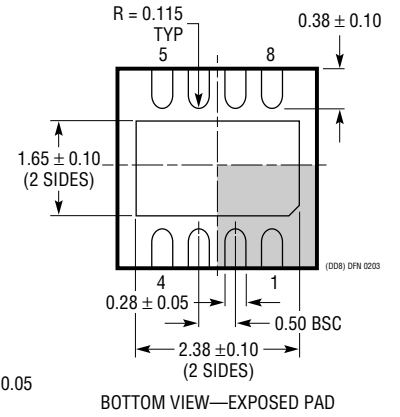
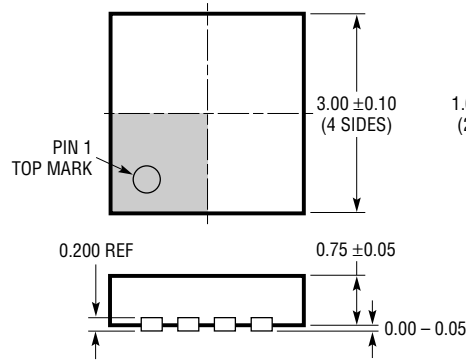

NOTE:

1. DRAWING TO BE MADE A JEDEC PACKAGE OUTLINE M0-229 VARIATION OF (WEED-1)
2. ALL DIMENSIONS ARE IN MILLIMETERS
3. DIMENSIONS OF EXPOSED PAD ON BOTTOM OF PACKAGE DO NOT INCLUDE MOLD FLASH. MOLD FLASH, IF PRESENT, SHALL NOT EXCEED 0.15mm ON ANY SIDE
4. EXPOSED PAD SHALL BE SOLDER PLATED

## PACKAGE DESCRIPTION

### S8 Package 8-Lead Plastic Small Outline (Narrow .150 Inch)

(Reference LTC DWG # 05-08-1610)

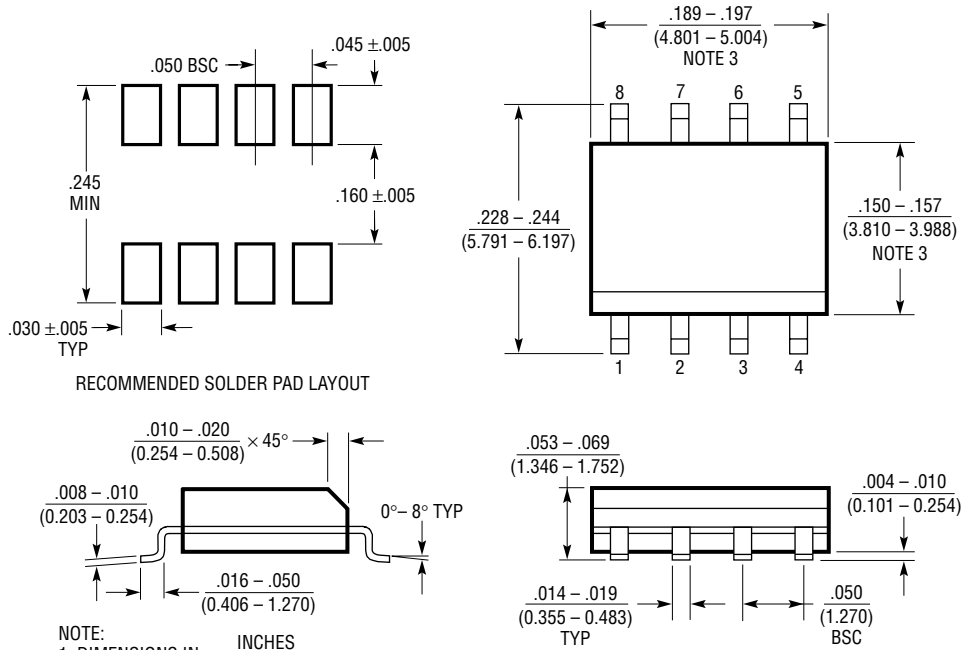

- NOTE:
1. DIMENSIONS IN  $\frac{\text{INCHES}}{\text{MILLIMETERS}}$
  2. DRAWING NOT TO SCALE
  3. THESE DIMENSIONS DO NOT INCLUDE MOLD FLASH OR PROTRUSIONS.  
 MOLD FLASH OR PROTRUSIONS SHALL NOT EXCEED .006" (0.15mm)

S08 0303

## PACKAGE DESCRIPTION

**GN Package**  
**16-Lead Plastic SSOP (Narrow .150 Inch)**  
(Reference LTC DWG # 05-08-1641)

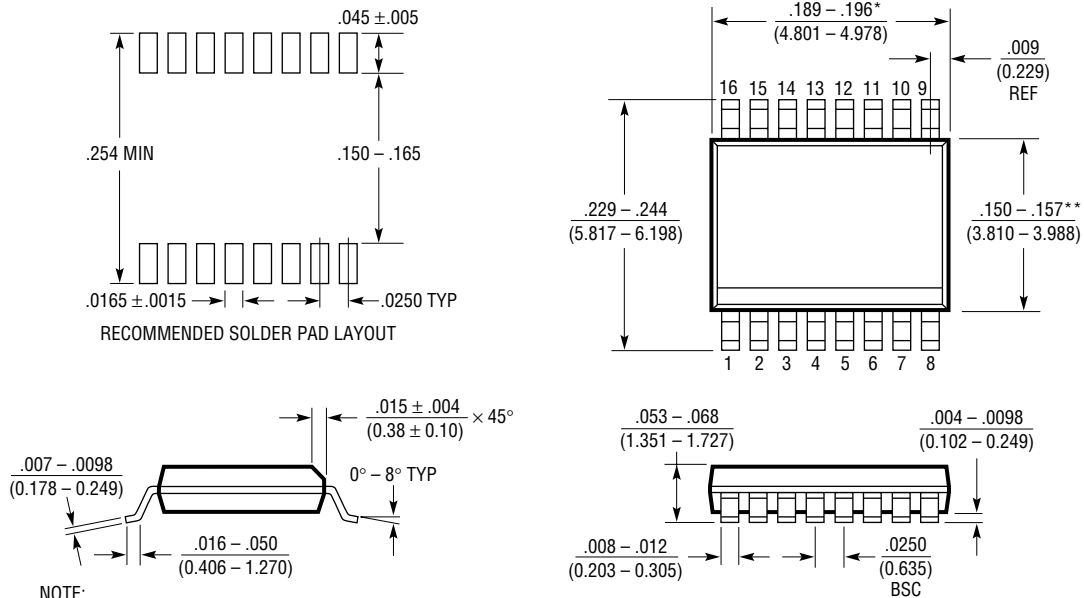

**NOTE:**

1. CONTROLLING DIMENSION: INCHES
  2. DIMENSIONS ARE IN  $\frac{\text{INCHES}}{\text{MILLIMETERS}}$
  3. DRAWING NOT TO SCALE
- \* DIMENSION DOES NOT INCLUDE MOLD FLASH. MOLD FLASH SHALL NOT EXCEED 0.006" (0.152mm) PER SIDE
- \*\* DIMENSION DOES NOT INCLUDE INTERLEAD FLASH. INTERLEAD FLASH SHALL NOT EXCEED 0.010" (0.254mm) PER SIDE

GN16 (SSOP) 0502

## TYPICAL APPLICATIONS

The LT6233 is applied as a transimpedance amplifier with an I-to-V conversion gain of 10kΩ set by R1. The LT6233 is ideally suited to this application because of its low input offset voltage and current, and its low noise. This is because the 10k resistor has an inherent thermal noise of 13nV/√Hz or 1.3pA/√Hz at room temperature, while the LT6233 contributes only 2nV and 0.8pA/√Hz. So, with respect to both voltage and current noises, the LT6233 is actually quieter than the gain resistor.

The circuit uses an avalanche photodiode with the cathode biased to approximately 200V. When light is incident on

the photodiode, it induces a current  $I_{PD}$  which flows into the amplifier circuit. The amplifier output falls negative to maintain balance at its inputs. The transfer function is therefore  $V_{OUT} = -I_{PD} \cdot 10k$ . C1 ensures stability and good settling characteristics. Output offset was measured at better than 500μV, so low in part because R2 serves to cancel the DC effects of bias current. Output noise was measured at below 1mV<sub>P-P</sub> on a 20MHz measurement bandwidth, with C2 shunting R2's thermal noise. As shown in the scope photo, the rise time is 45ns, indicating a signal bandwidth of 7.8MHz.

**Low Power Avalanche Photodiode Transimpedance Amplifier**  
 $I_S = 1.2mA$

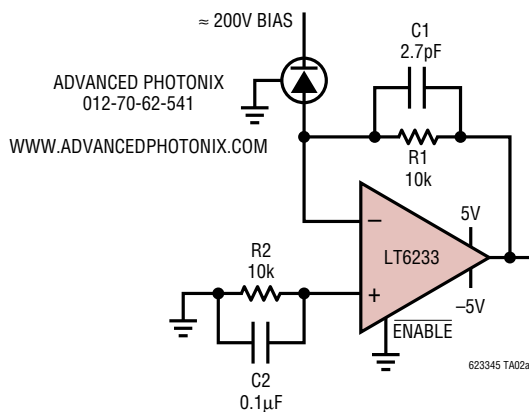

OUTPUT OFFSET = 500μV TYPICAL  
BANDWIDTH = 7.8MHz  
OUTPUT NOISE = 1mV<sub>P-P</sub> (20MHz MEASUREMENT BW)

**Photodiode Amplifier Time Domain Response**

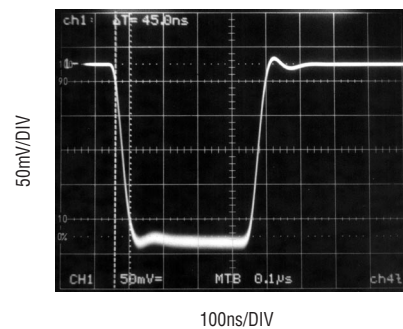

623345 TA02b

## RELATED PARTS

PART NUMBER	DESCRIPTION	COMMENTS
LT1028	Single, Ultra Low Noise 50MHz Op Amp	0.85nV/√Hz
LT1677	Single, Low Noise Rail-to-Rail Amplifier	3V Operation, 2.5mA, 4.5nV/√Hz, 60μV Max $V_{OS}$
LT1806/LT1807	Single/Dual, Low Noise 325MHz Rail-to-Rail Amplifier	2.5V Operation, 550μV Max $V_{OS}$ , 3.5nV/√Hz
LT6200/LT6201	Single/Dual, Low Noise 165MHz	0.95nV/√Hz, Rail-to-Rail Input and Output
LT6202/LT6203/LT6204	Single/Dual/Quad, Low Noise, Rail-to-Rail Amplifier	1.9nV/√Hz, 3mA Max, 100MHz Gain Bandwidth