

The specifications for the **LTC<sup>®</sup>1090CS** are identical to those of the **LTC1090CN**. For complete specifications, typical performance curves and applications information, please see the **LTC1090** data sheet.

LT, LTC and LT are registered trademarks of Linear Technology Corporation.

## PACKAGE/ORDER INFORMATION

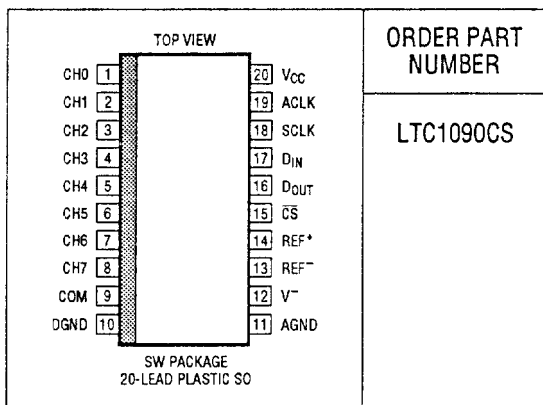

For further information regarding this specification notice contact:

Linear Technology Corporation  
 1630 McCarthy Blvd.  
 Milpitas, California 95035-7417  
 Attn: Product Marketing Manager  
 Phone: (408) 432-1900

## FEATURES

- Software Programmable Features:
  - Unipolar/Bipolar Conversions
  - 4 Differential/8 Single Ended Inputs
  - MSB or LSB First Data Sequence
  - Variable Data Word Length
- Built-In Sample and Hold
- Single Supply 5V, 10V or  $\pm 5V$  Operation
- Direct 4 Wire Interface to Most MPU Serial Ports and All MPU Parallel Ports
- 30kHz Maximum Throughput Rate

## KEY SPECIFICATIONS

- |                                     |                         |
|-------------------------------------|-------------------------|
| ■ Resolution                        | 10 Bits                 |
| ■ Total Unadjusted Error (LTC1090A) | $\pm 1/2\text{LSB}$ Max |
| ■ Conversion Time                   | 22 $\mu\text{s}$        |
| ■ Supply Current                    | 2.5mA Max, 1.0mA Typ    |

## DESCRIPTION

The LTC1090 is a data acquisition component which contains a serial I/O successive approximation A/D converter. It uses LTCMOSTM switched capacitor technology to perform either 10-bit unipolar, or 9-bit plus sign bipolar A/D conversions. The 8-channel input multiplexer can be configured for either single ended or differential inputs (or combinations thereof). An on-chip sample and hold is included for all single ended input channels.

The serial I/O is designed to be compatible with industry standard full duplex serial interfaces. It allows either MSB or LSB first data and automatically provides 2's complement output coding in the bipolar mode. The output data word can be programmed for a length of 8, 10, 12 or 16 bits. This allows easy interface to shift registers and a variety of processors.

The LTC1090A is specified with total unadjusted error (including the effects of offset, linearity and gain errors) less than  $\pm 0.5\text{LSB}$ .

The LTC1090 is specified with offset and linearity less than  $\pm 0.5\text{LSB}$  but with a gain error limit of  $\pm 2\text{LSB}$  for applications where gain is adjustable or less critical.

LTCMOS is a trademark of Linear Technology Corp.

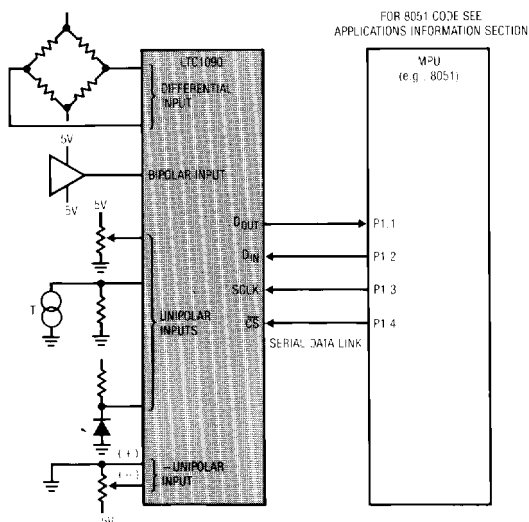

Linearity Plot

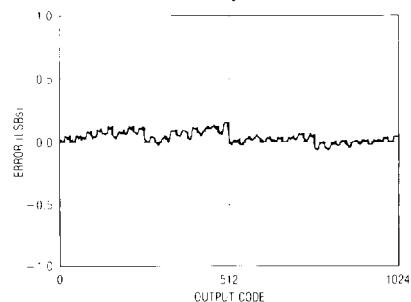

**ABSOLUTE MAXIMUM RATINGS**

**PACKAGE/ORDER INFORMATION**

(Notes 1 and 2)

Supply Voltage ( $V_{CC}$ ) to GND or  $V^-$  ..... 12V  
 Negative Supply Voltage ( $V^-$ ) ..... -6V to GND  
 Voltage

Analog and Reference  
 Inputs ..... ( $V^-$ ) - 0.3V to  $V_{CC} + 0.3V$   
 Digital Inputs ..... - 0.3V to 12V  
 Digital Outputs ..... - 0.3V to  $V_{CC} + 0.3V$   
 Power Dissipation ..... 500mW  
 Operating Temperature Range  
 LTC1090AC, LTC1090C ..... -40°C to 85°C  
 LTC1090AM, LTC1090M ..... -55°C to 125°C  
 Storage Temperature Range ..... -65°C to 150°C  
 Lead Temperature (Soldering, 10 sec.) ..... 300°C

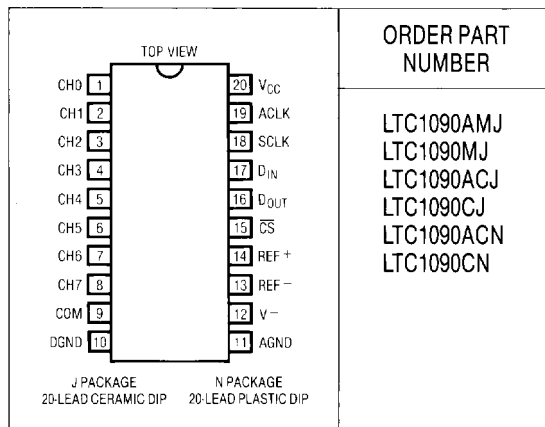

ORDER PART  
NUMBER

- LTC1090AMJ
- LTC1090MJ
- LTC1090ACJ
- LTC1090CJ
- LTC1090ACN
- LTC1090CN

**RECOMMENDED OPERATING CONDITIONS**

SYMBOL	PARAMETER	CONDITIONS	LTC1090/LTC1090A		UNITS
			MIN	MAX	
$V_{CC}$	Positive Supply Voltage	$V^- = 0V$	4.5	10	V
$V^-$	Negative Supply Voltage	$V_{CC} = 5V$	-5.5	0	V
$f_{SCLK}$	Shift Clock Frequency	$V_{CC} = 5V$	0	1.0	MHz
$f_{ACLK}$	A/D Clock Frequency	$V_{CC} = 5V$	0.01 0.05 0.25	2.0 2.0 2.0	MHz
$t_{CYC}$	Total Cycle Time	See Operating Sequence	10 SCLK + 48 ACLK		Cycles
$t_{HCS}$	Hold Time, $\overline{CS}$ Low After Last SCLKI	$V_{CC} = 5V$	0		ns
$t_{HDI}$	Hold Time, $D_{IN}$ After SCLKI	$V_{CC} = 5V$	150		ns
$t_{SU\overline{CS}}$	Setup Time $\overline{CS}_i$ Before Clocking in First Address Bit (Note 9)	$V_{CC} = 5V$	2 ACLK Cycles + 1 $\mu$ s		
$t_{SU\overline{DI}}$	Setup Time, $D_{IN}$ Stable Before SCLKI	$V_{CC} = 5V$	400		ns
$t_{WHACLK}$	ACLK High Time	$V_{CC} = 5V$	127		ns
$t_{WLACLK}$	ACLK Low Time	$V_{CC} = 5V$	200		ns
$t_{WH\overline{CS}}$	$\overline{CS}$ High Time During Conversion	$V_{CC} = 5V$	44		ACLK Cycles

**CONVERTER AND MULTIPLEXER CHARACTERISTICS** (Note 3)

PARAMETER	CONDITIONS		LTC1090A			LTC1090			UNITS
			MIN	TYP	MAX	MIN	TYP	MAX	
Offset Error	(Note 4)	●			± 0.5			± 0.5	LSB
Linearity Error	(Notes 4 and 5)	●			± 0.5			± 0.5	LSB
Gain Error	(Note 4)	●			± 0.5			± 2.0	LSB
Total Unadjusted Error	$V_{REF} = 5.000V$ (Notes 4 and 6)	●			± 0.5				LSB

## CONVERTER AND MULTIPLEXER CHARACTERISTICS (Note 3)

PARAMETER	CONDITIONS	LTC1090A			LTC1090			UNITS
		MIN	TYP	MAX	MIN	TYP	MAX	
Reference Input Resistance			10			10		k $\Omega$
Analog and REF Input Range	(Note 7)			(V <sup>-</sup> ) - 0.05V to V <sub>CC</sub> + 0.05V				V
On Channel Leakage Current (Note 8)	On Channel = 5V Off Channel = 0V	●		1		1		$\mu$ A
	On Channel = 0V Off Channel = 5V	●		-1		-1		$\mu$ A
Off Channel Leakage Current (Note 8)	On Channel = 5V Off Channel = 0V	●		-1		-1		$\mu$ A
	On Channel = 0V Off Channel = 5V	●		1		1		$\mu$ A

## AC CHARACTERISTICS (Note 3)

SYMBOL	PARAMETER	CONDITIONS	LTC1090/LTC1090A			UNITS
			MIN	TYP	MAX	
t <sub>ACC</sub>	Delay Time From CS1 to D <sub>OUT</sub> Data Valid	(Note 9)		2		ACLK Cycles
t <sub>SMPLE</sub>	Analog Input Sample Time	See Operating Sequence		5		SCLK Cycles
t <sub>CONV</sub>	Conversion Time	See Operating Sequence		44		ACLK Cycles
t <sub>dDO</sub>	Delay Time, SCLK1 to D <sub>OUT</sub> Data Valid	See Test Circuits	●	250	450	ns
t <sub>dis</sub>	Delay Time, CS1 to D <sub>OUT</sub> Hi-Z	See Test Circuits	●	140	300	ns
t <sub>en</sub>	Delay Time, 2nd CLK1 to D <sub>OUT</sub> Enabled	See Test Circuits	●	150	400	ns
t <sub>hDO</sub>	Time Output Data Remains Valid After SCLK1			50		ns
t <sub>f</sub>	D <sub>OUT</sub> Fall Time	See Test Circuits	●	90	300	ns
t <sub>r</sub>	D <sub>OUT</sub> Rise Time	See Test Circuits	●	60	300	ns
C <sub>IN</sub>	Input Capacitance	Analog Inputs On Channel		65		pF
		Off Channel		5		pF
		Digital Inputs		5		pF

## DIGITAL AND DC ELECTRICAL CHARACTERISTICS (Note 3)

SYMBOL	PARAMETER	CONDITIONS	LTC1090/LTC1090A			UNITS
			MIN	TYP	MAX	
V <sub>IH</sub>	High Level Input Voltage	V <sub>CC</sub> = 5.25V	●	2.0		V
V <sub>IL</sub>	Low Level Input Voltage	V <sub>CC</sub> = 4.75V	●		0.8	V
I <sub>IH</sub>	High Level Input Current	V <sub>IN</sub> = V <sub>CC</sub>	●		2.5	$\mu$ A
I <sub>IL</sub>	Low Level Input Current	V <sub>IN</sub> = 0V	●		-2.5	$\mu$ A
V <sub>OH</sub>	High Level Output Voltage	V <sub>CC</sub> = 4.75V, I <sub>O</sub> = 10 $\mu$ A	●	4.7		V
		I <sub>O</sub> = 360 $\mu$ A	●	2.4	4.0	V
V <sub>OL</sub>	Low Level Output Voltage	V <sub>CC</sub> = 4.75V, I <sub>O</sub> = 1.6mA	●		0.4	V
I <sub>OZ</sub>	Hi-Z Output Leakage	V <sub>OUT</sub> = V <sub>CC</sub> , CS High	●		3	$\mu$ A
		V <sub>OUT</sub> = 0V, CS High	●		-3	$\mu$ A
I <sub>SOURCE</sub>	Output Source Current	V <sub>OUT</sub> = 0V			-10	mA
I <sub>SINK</sub>	Output Sink Current	V <sub>OUT</sub> = V <sub>CC</sub>			10	mA
I <sub>CC</sub>	Positive Supply Current	CS High, REF <sup>+</sup> Open	●	1.0	2.5	mA
I <sub>REF</sub>	Reference Current	V <sub>REF</sub> = 5V	●	0.5	1.0	mA
I <sup>-</sup>	Negative Supply Current	CS High, V <sup>-</sup> = -5V	●	1	50	$\mu$ A

**Note 1:** Absolute maximum ratings are those values beyond which the life of a device may be impaired.

**Note 2:** All voltage values are with respect to ground with DGND, AGND and REF<sup>-</sup> wired together (unless otherwise noted).

**Note 3:**  $V_{CC} = 5V$ ,  $V_{REF+} = 5V$ ,  $V_{REF-} = 0V$ ,  $V^- = 0V$  for unipolar mode and  $-5V$  for bipolar mode,  $ACLK = 2.0\text{ MHz}$ ,  $SCLK = 0.5\text{ MHz}$  unless otherwise specified. The ● indicates specs which apply over the full operating temperature range; all other limits and typicals  $T_A = 25^\circ\text{C}$ .

**Note 4:** These specs apply for both unipolar and bipolar modes. In bipolar mode, one LSB is equal to the bipolar input span ( $2V_{REF}$ ) divided by 1024. For example, when  $V_{REF} = 5V$ ,  $1\text{ LSB (bipolar)} = 2(5V)/1024 = 9.77\text{ mV}$ .

**Note 5:** Linearity error is specified between the actual end points of the A/D transfer curve.

**Note 6:** Total unadjusted error includes offset, gain, linearity, multiplexer and hold step errors.

**Note 7:** Two on-chip diodes are tied to each reference and analog input which will conduct for reference or analog input voltages one diode drop below  $V^-$  or one diode drop above  $V_{CC}$ . Be careful during testing at low  $V_{CC}$  levels (4.5V), as high level reference or analog inputs (5V) can cause this input diode to conduct, especially at elevated temperatures, and cause errors for inputs near full-scale. This spec allows 50mV forward bias of either diode. This means that as long as the reference or analog input does not exceed the supply voltage by more than 50mV, the output code will be correct. To achieve an absolute 0V to 5V input voltage range will therefore require a minimum supply voltage of 4.950V over initial tolerance, temperature variations and loading.

**Note 8:** Channel leakage current is measured after the channel selection.

**Note 9:** To minimize errors caused by noise at the chip select input, the internal circuitry waits for two ACLK falling edges after a chip select falling edge is detected before responding to control input signals. Therefore, no attempt should be made to clock an address in or data out until the minimum chip select setup time has elapsed.

## TEST CIRCUITS

On and Off Channel Leakage Current

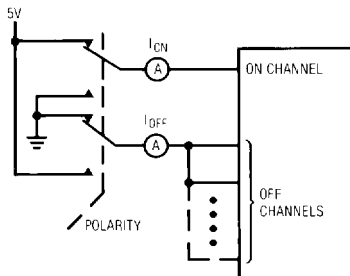

Voltage Waveforms for  $D_{OUT}$  Delay Time,  $t_{dD}$

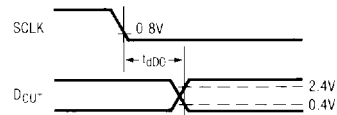

Voltage Waveform for  $D_{OUT}$  Rise and Fall Times,  $t_r$ ,  $t_f$

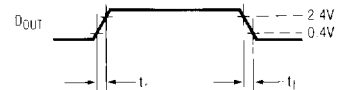

Voltage Waveforms for  $t_{en}$  and  $t_{dis}$

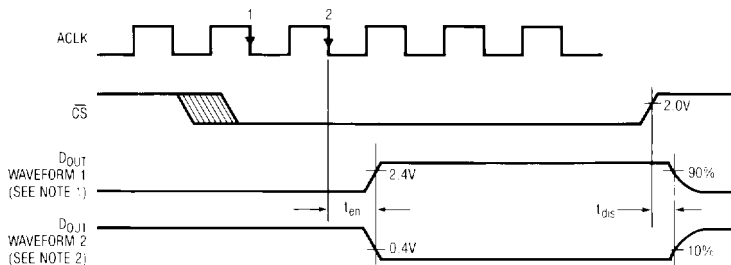

NOTE 1: WAVEFORM 1 IS FOR AN OUTPUT WITH INTERNAL CONDITIONS SUCH THAT THE OUTPUT IS HIGH UNLESS DISABLED BY THE OUTPUT CONTROL.

NOTE 2: WAVEFORM 2 IS FOR AN OUTPUT WITH INTERNAL CONDITIONS SUCH THAT THE OUTPUT IS LOW UNLESS DISABLED BY THE OUTPUT CONTROL.

## TEST CIRCUITS

Load Circuit for  $t_{dis}$  and  $t_{en}$

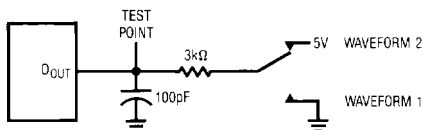

Load Circuit for  $t_{DDO}$ ,  $t_r$ , and  $t_f$

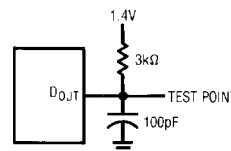

## PIN FUNCTIONS

#	PIN	FUNCTION	DESCRIPTION
1-8	CH0-CH7	Analog Inputs	The analog inputs must be free of noise with respect to AGND.
9	COM	Common	The common pin defines the zero reference point for all single ended inputs. It must be free of noise and is usually tied to the analog ground plane.
10	DGND	Digital Ground	This is the ground for the internal logic. Tie to the ground plane.
11	AGND	Analog Ground	AGND should be tied directly to the analog ground plane.
12	V <sup>-</sup>	Negative Supply	Tie V <sup>-</sup> to most negative potential in the circuit. (Ground in single supply applications.)
13, 14	REF <sup>-</sup> , REF <sup>+</sup>	Reference Inputs	The reference inputs must be kept free of noise with respect to AGND
15	CS	Chip Select Input	A logic low on this input enables data transfer.
16	D <sub>OUT</sub>	Digital Data Output	The A/D conversion result is shifted out of this output.
17	D <sub>IN</sub>	Data Input	The A/D configuration word is shifted into this input.
18	SCLK	Shift Clock	This clock synchronizes the serial data transfer.
19	ACLK	A/D Conversion Clock	This clock controls the A/D conversion process.
20	V <sub>CC</sub>	Positive Supply	This supply must be kept free of noise and ripple by bypassing directly to the analog ground plane.

## BLOCK DIAGRAM

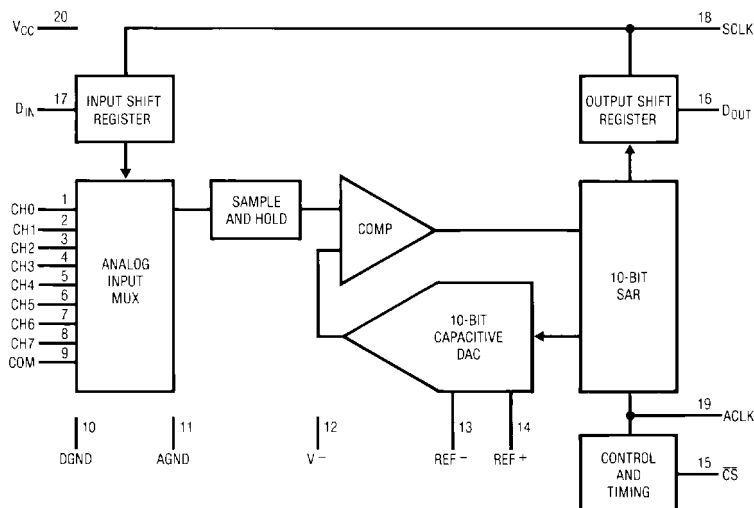

# TYPICAL PERFORMANCE CHARACTERISTICS

Supply Current vs Supply Voltage

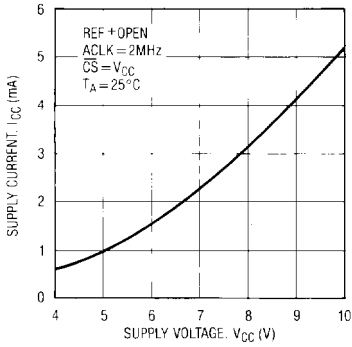

Supply Current vs Temperature

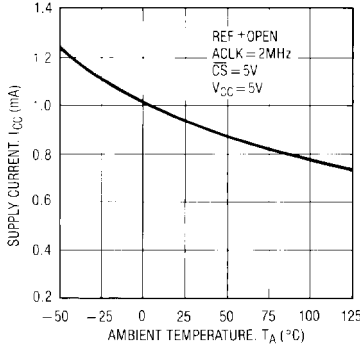

Reference Current vs Temperature

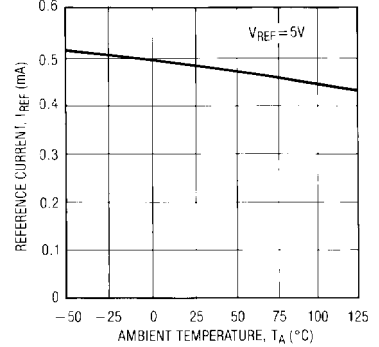

Unadjusted Offset Error vs Reference Voltage

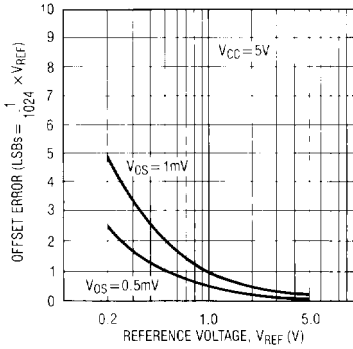

Linearity Error vs Reference Voltage

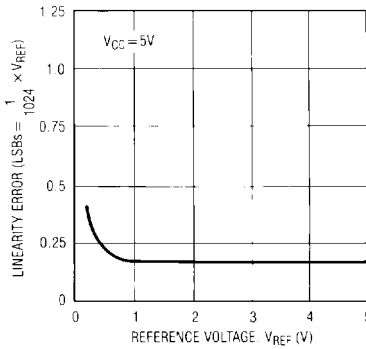

Change in Gain Error vs Reference Voltage

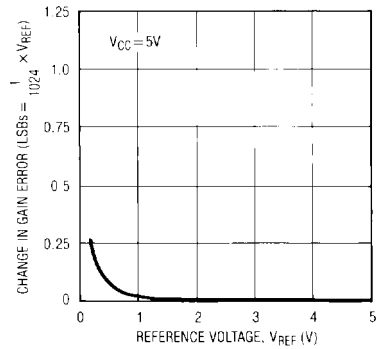

Offset Error vs Supply Voltage

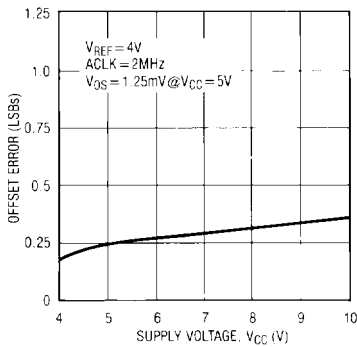

Linearity Error vs Supply Voltage

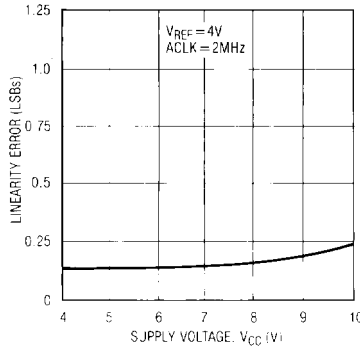

Change in Gain Error vs Supply Voltage

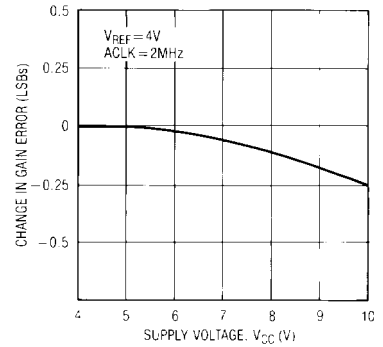

# TYPICAL PERFORMANCE CHARACTERISTICS

**Change in Offset Error vs Temperature**

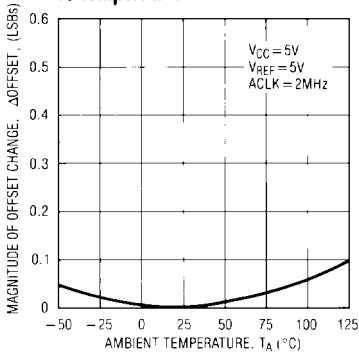

**Change in Linearity Error vs Temperature**

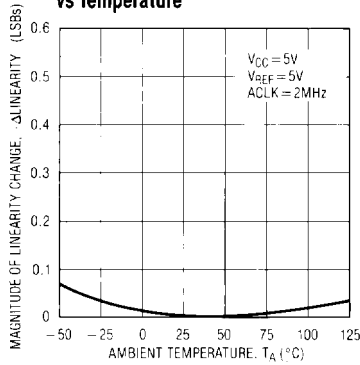

**Change in Gain Error vs Temperature**

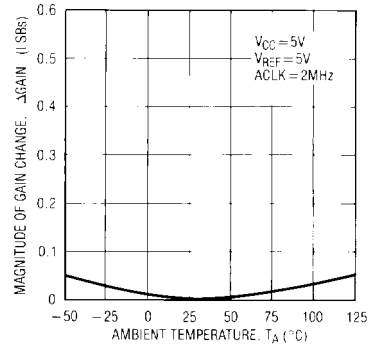

**Maximum Conversion Clock Rate vs Temperature**

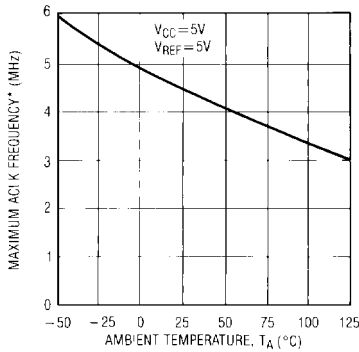

**Maximum Conversion Clock Rate vs Reference Voltage**

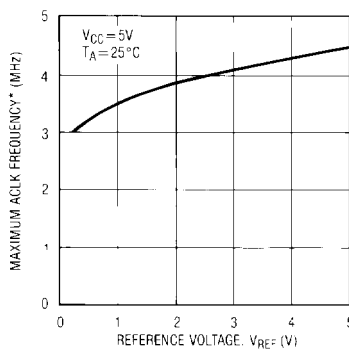

**Maximum Conversion Clock Rate vs Supply Voltage**

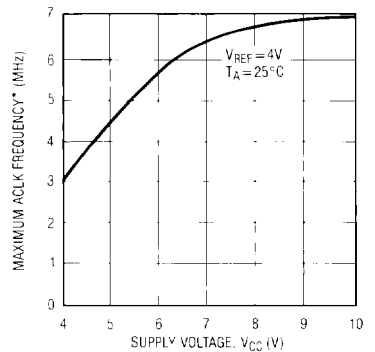

**Maximum Conversion Clock Rate vs Source Resistance**

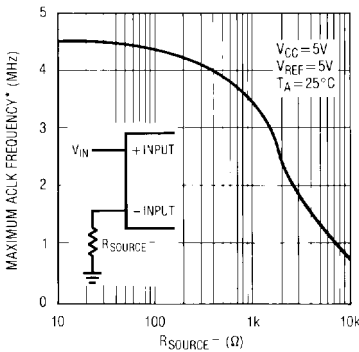

**Maximum Filter Resistor vs Cycle Time**

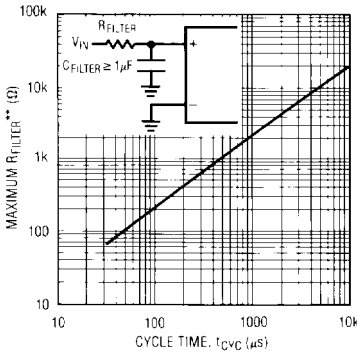

**Sample and Hold Acquisition Time vs Source Resistance**

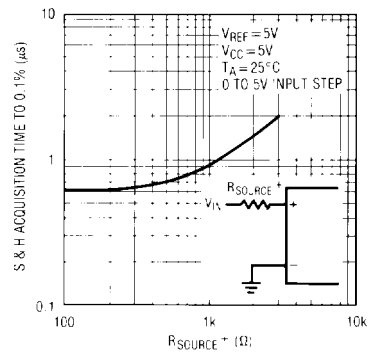

\*MAXIMUM ACLK FREQUENCY REPRESENTS THE ACLK FREQUENCY AT WHICH A 0.1LSB SHIFT IN THE ERROR AT ANY CODE TRANSITION FROM ITS 2MHz VALUE IS FIRST DETECTED

\*\*MAXIMUM R\_FILTER REPRESENTS THE FILTER RESISTOR VALUE AT WHICH A 0.1LSB CHANGE IN FULL-SCALE ERROR FROM ITS VALUE AT R\_FILTER = 0 IS FIRST DETECTED



## TYPICAL PERFORMANCE CHARACTERISTICS

Digital Input Logic Threshold vs Supply Voltage

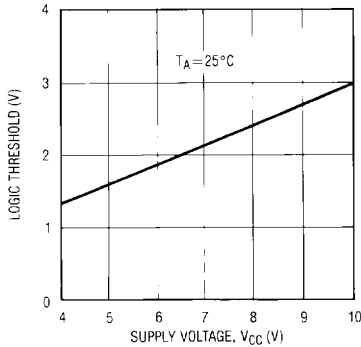

Input Channel Leakage Current vs Temperature

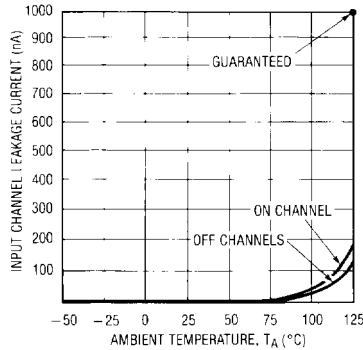

Noise Error vs Reference Voltage

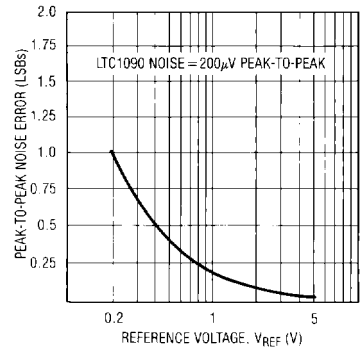

## APPLICATIONS INFORMATION

The LTC1090 is a data acquisition component which contains the following functional blocks:

1. 10-bit successive approximation capacitive A/D converter
2. Analog multiplexer (MUX)
3. Sample and hold (S/H)
4. Synchronous, full duplex serial interface
5. Control and timing logic

## DIGITAL CONSIDERATIONS

### 1. Serial Interface

The LTC1090 communicates with microprocessors and other external circuitry via a synchronous, full duplex, four wire serial interface (see Operating Sequence). The shift clock (SCLK) synchronizes the data transfer with each bit being transmitted on the falling SCLK edge and captured on the rising SCLK edge in both transmitting and receiving systems. The data is transmitted and received simultaneously (full duplex).

Operating Sequence  
(Example: Differential Inputs (CH3-CH2), Bipolar, MSB First and 10-Bit Word Length)

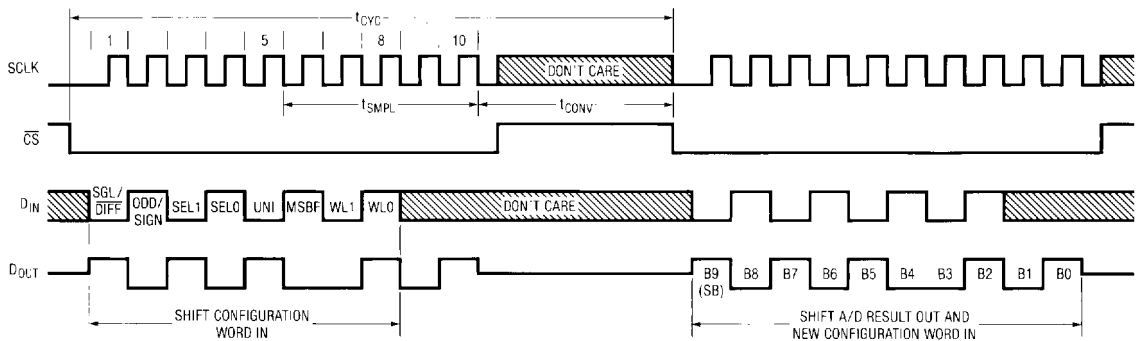

## APPLICATIONS INFORMATION

Data transfer is initiated by a falling chip select ( $\overline{CS}$ ) signal. After the falling  $\overline{CS}$  is recognized, an 8-bit input word is shifted into the  $D_{IN}$  input which configures the LTC1090 for the next conversion. Simultaneously, the result of the previous conversion is output on the  $D_{OUT}$  line. At the end of the data exchange the requested conversion begins and  $\overline{CS}$  should be brought high. After  $t_{CONV}$ , the conversion is complete and the results will be available on the next data transfer cycle. As shown below, the result of a conversion is delayed by one  $\overline{CS}$  cycle from the input word requesting it.

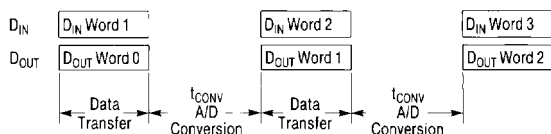

### 2. Input Data Word

The LTC1090 8-bit input data word is clocked into the  $D_{IN}$  input on the first eight rising SCLK edges after chip select is recognized. Further inputs on the  $D_{IN}$  pin are then ignored until the next  $\overline{CS}$  cycle. The eight bits of the input word are defined as follows:

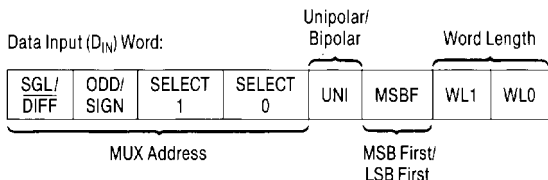

### Multiplexer (MUX) Address

The first four bits of the input word assign the MUX configuration for the requested conversion. For a given channel selection, the converter will measure the voltage between the two channels indicated by the + and - signs in the selected row of Table 1. Note that in differential mode ( $SGL/DIFF=0$ ) measurements are limited to four adjacent input pairs with either polarity. In single ended mode, all input channels are measured with respect to COM. Figure 1 shows some examples of multiplexer assignments.

Table 1. Multiplexer Channel Selection

MUX ADDRESS			DIFFERENTIAL CHANNEL SELECTION									
SGL/DIFF	ODD/SIGN	SELECT	1	0	0	1	2	3	4	5	6	7
0	0	0	0	+	-							
0	0	0	1			+	-					
0	0	1	0						+	-		
0	0	1	1								+	-
0	1	0	0	-	+							
0	1	0	1			-	+					
0	1	1	0						-	+		
0	1	1	1								-	+

MUX ADDRESS			SINGLE ENDED CHANNEL SELECTION										
SGL/DIFF	ODD/SIGN	SELECT	1	0	0	1	2	3	4	5	6	7	COM
1	0	0	0	+									-
1	0	0	1			+							-
1	0	1	0					+					-
1	0	1	1								+		-
1	1	0	0		+								-
1	1	0	1				+						-
1	1	1	0						+				-
1	1	1	1									+	-

# APPLICATIONS INFORMATION

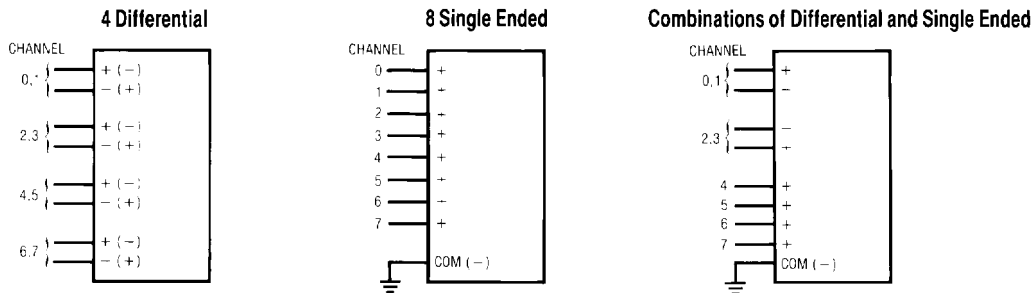

### Changing the MUX Assignment "On the Fly"

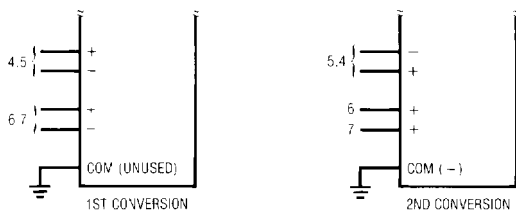

Figure 1. Examples of Multiplexer Options on the LTC1090

### Unipolar/Bipolar (UNI)

The fifth input bit (UNI) determines whether the conversion will be unipolar or bipolar. When UNI is a logical one, a unipolar conversion will be performed on the selected in-

put voltage. When UNI is a logical zero, a bipolar conversion will result. The input span and code assignment for each conversion type are shown in the figures below.

#### Unipolar Transfer Curve (UNI = 1)

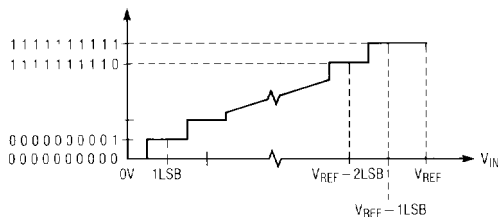

#### Bipolar Transfer Curve (UNI = 0)

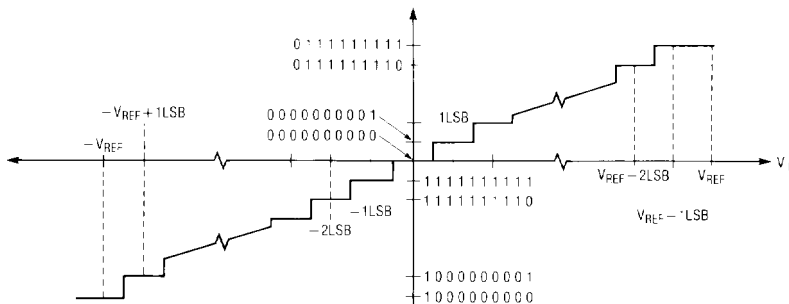

## APPLICATIONS INFORMATION

### Unipolar Output Code (UNI = 1)

OUTPUT CODE	INPUT VOLTAGE	INPUT VOLTAGE ( $V_{REF} = 5V$ )
1111111111	$V_{REF} - 1LSB$	4.9951V
1111111110	$V_{REF} - 2LSB$	4.9902V
⋮	⋮	⋮
0000000001	1LSB	0.0049V
0000000000	0V	0V

### Bipolar Output Code (UNI = 0)

OUTPUT CODE	INPUT VOLTAGE	INPUT VOLTAGE ( $V_{REF} = 5V$ )
0111111111	$V_{REF} - 1LSB$	4.9902V
0111111110	$V_{REF} - 2LSB$	4.9805V
⋮	⋮	⋮
0000000001	1LSB	0.0098V
0000000000	0V	0V
1111111111	-1LSB	-0.0098V
1111111110	-2LSB	-0.0195V
⋮	⋮	⋮
1000000001	$-(V_{REF}) + 1LSB$	-4.9902V
1000000000	$-(V_{REF})$	-5.000V

### MSB First/LSB First Format (MSBF)

The output data of the LTC1090 is programmed for MSB first or LSB first sequence using the MSBF bit. For MSB first output data the input word clocked to the LTC1090 should always contain a logical one in the sixth bit location (MSBF bit). Likewise for LSB first output data, the input word clocked to the LTC1090 should always contain a zero in the MSBF bit location. The MSBF bit in a given  $D_{IN}$  word will control the order of the next  $D_{OUT}$  word. The MSBF bit affects only the order of the output data word. The order of the input word is unaffected by this bit.

MSBF	OUTPUT FORMAT
0	LSB First
1	MSB First

### Word Length (WL1, WL0)

The last two bits of the input word (WL1 and WL0) program the output data word length of the LTC1090. Word lengths of 8, 10, 12 or 16 bits can be selected according to the following table. The WL1 and WL0 bits in a given  $D_{IN}$  word

control the length of the present, not the next,  $D_{OUT}$  word. **WL1 and WL0 are never “don’t cares”** and must be set for the correct  $D_{OUT}$  word length even when a “dummy”  $D_{IN}$  word is sent. On any transfer cycle, the word length should be made equal to the number of SCLK cycles sent by the MPU.

WL1	WL0	OUTPUT WORD LENGTH
0	0	8 Bits
0	1	10 Bits
1	0	12 Bits
1	1	16 Bits

Figure 2 shows how the data output ( $D_{OUT}$ ) timing can be controlled with word length selection and MSB/LSB first format selection.

### 3. Deglitcher

A deglitching circuit has been added to the Chip Select input of the LTC1090 to minimize the effects of errors caused by noise on that input. This circuit ignores changes in state on the  $\overline{CS}$  input that are shorter in duration than 1 ACLK cycle. After a change of state on the  $\overline{CS}$  input, the LTC1090 waits for two falling edges of the ACLK before recognizing a valid chip select. One indication of  $\overline{CS}$  low recognition is the  $D_{OUT}$  line becoming active (leaving the Hi-Z state). Note that the deglitching applies to both the rising and falling  $\overline{CS}$  edges.

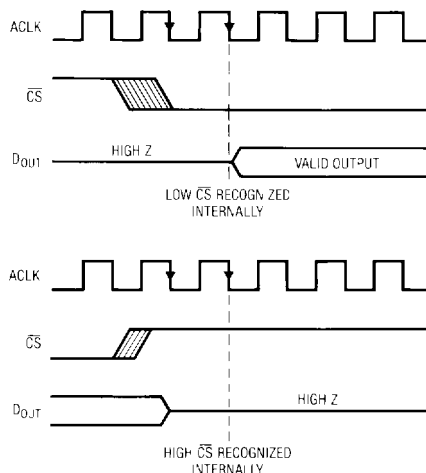

# APPLICATIONS INFORMATION

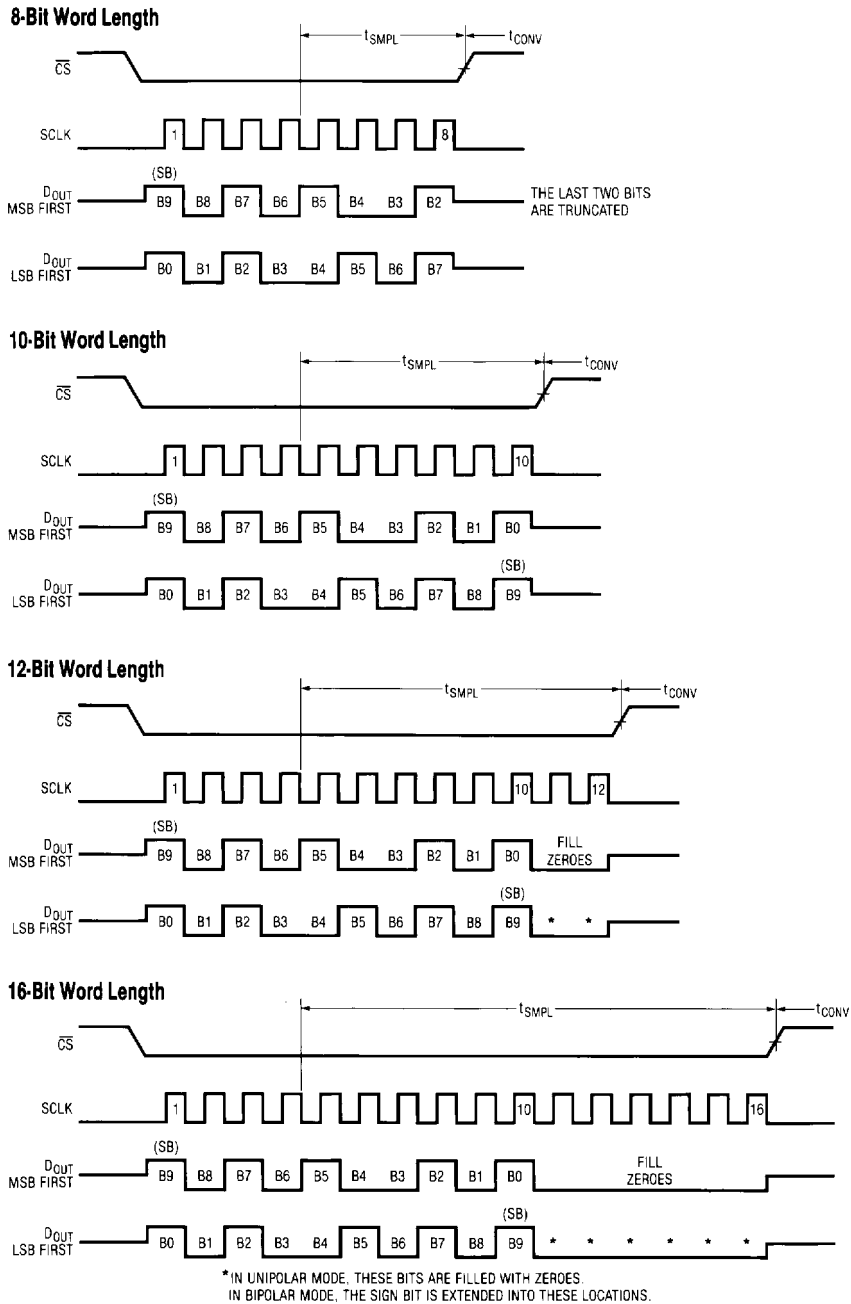

Figure 2. Data Output ( $D_{OUT}$ ) Timing with Different Word Lengths

## APPLICATIONS INFORMATION

### 4. $\overline{CS}$ Low During Conversion

In the normal mode of operation,  $\overline{CS}$  is brought high during the conversion time (see Figure 3). The serial port ignores any SCLK activity while  $\overline{CS}$  is high. The LTC1090 will also operate with  $\overline{CS}$  low during the conversion. In this mode, SCLK must remain low during the conversion as shown in Figure 4. After the conversion is complete, the  $D_{OUT}$  line

will become active with the first output bit. Then the data transfer can begin as normal.

### 5. Microprocessor Interfaces

The LTC1090 can interface directly (without external hardware) to most popular microprocessor (MPU) synchronous

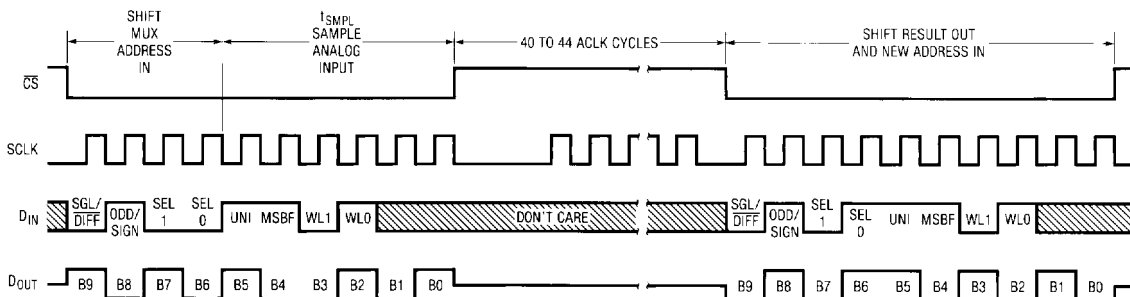

Figure 3.  $\overline{CS}$  High During Conversion

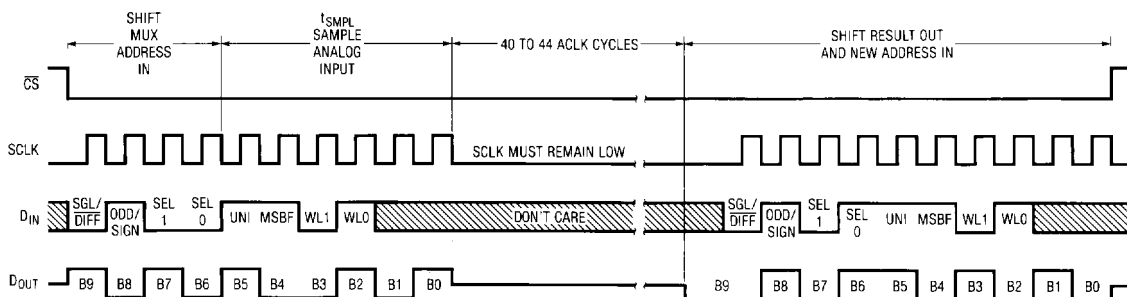

Figure 4.  $\overline{CS}$  Low During Conversion

## APPLICATIONS INFORMATION

serial formats (see Table 2). If an MPU without a serial interface is used, then 4 of the MPU's parallel port lines can be programmed to form the serial link to the LTC1090. Included here are three serial interface examples and one example showing a parallel port programmed to form the serial interface.

**Table 2. Microprocessors with Hardware Serial Interfaces Compatible with the LTC1090\*\***

PART NUMBER	TYPE OF INTERFACE
<b>Motorola</b>	
MC6805S2, S3	SPI
MC68HC11	SPI
MC68HC05	SPI
<b>RCA</b>	
CDP68HC05	SPI
<b>Hitachi</b>	
HD6305	SCI Synchronous
HD63705	SCI Synchronous
HD6301	SCI Synchronous
HD63701	SCI Synchronous
HD6303	SCI Synchronous
<b>National Semiconductor</b>	
COP400 Family	MICROWIRE†
COP800 Family	MICROWIRE/PLUS†
NS8050U	MICROWIRE/PLUS
HPC16000 Family	MICROWIRE/PLUS
<b>Texas Instruments</b>	
TMS7002	Serial Port
TMS7042	Serial Port
TMS70C02	Serial Port
TMS70C42	Serial Port
TMS32011*	Serial Port
TMS32020*	Serial Port

\*Requires external hardware

\*\*Contact factory for interface information for processors not on this list

†MICROWIRE and MICROWIRE/PLUS are trademarks of National Semiconductor Corp.

### Serial Port Microprocessors

Most synchronous serial formats contain a shift clock (SCLK) and two data lines, one for transmitting and one for receiving. In most cases data bits are transmitted on the falling edge of the clock (SCLK) and captured on the rising edge. However, serial port formats vary among MPU manufacturers as to the smallest number of bits that can be sent in one group (e.g., 4-bit, 8-bit or 16-bit transfers). They also vary as to the order in which the bits are transmitted (LSB or MSB first). The following examples show how the LTC1090 accommodates these differences.

### National MICROWIRE (COP420)

The COP420 transfers data MSB first and in 4-bit increments (nibbles). This is easily accommodated by setting the LTC1090 to MSB first format and 12-bit word length. The data output word is then received by the COP420 in three 4-bit blocks with the final two unused bits filled with zeroes by the LTC1090.

### Hardware and Software Interface to National Semiconductor COP420 Processor

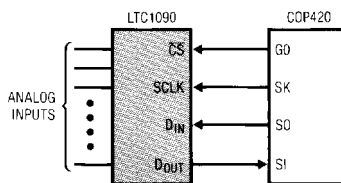

D<sub>OUT</sub> from LTC1090 stored in COP420 RAM

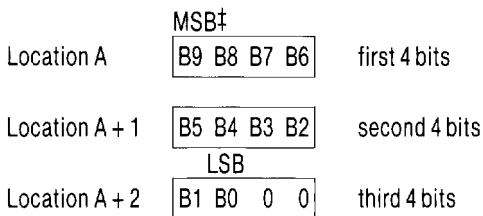

‡B9 is MSB in unipolar or sign bit in bipolar

MNEMONIC	DESCRIPTION
LEI	Enable SIO
SC	Set Carry flag
OGI	G0 is set to 0 (CS goes low)
LDD	Load first 4 bits of D <sub>IN</sub> to ACC
XAS	Swap ACC with SIO reg. Starts SK Clk
LDD	Load 2nd 4 bits of D <sub>IN</sub> to ACC
NOP	Timing
XAS	Swap first 4 bits from A/D with ACC. SK continues.
XIS	Put first 4 bits in RAM (location A)
NOP	Timing
XAS	Swap 2nd 4 bits from A/D with ACC. SK continues.
XIS	Put 2nd 4 bits in RAM (location A + 1)
RC	Clear Carry
NOP	Timing
XAS	Swap 3rd 4 bits from A/D with ACC. SK off
XIS	Put 3rd 4 bits in RAM (location A + 2)
OGI	G0 is set to 1 (CS goes high)
LEI	Disable SIO

## APPLICATIONS INFORMATION

### Motorola SPI (MC68HC05C4)

The MC68HC05C4 transfers data MSB first and in 8-bit increments. Programming the LTC1090 for MSB first format and 16-bit word length allows the 10-bit data output to be received by the MPU as two 8-bit bytes with the final 6 unused bits filled with zeroes by the LTC1090.

#### Hardware and Software Interface to Motorola MC68HC05C4 Processor

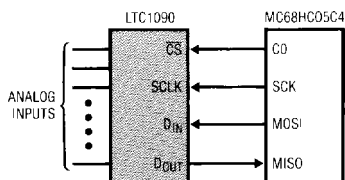

D<sub>OUT</sub> from LTC1090 stored in MC68HC05C4 RAM

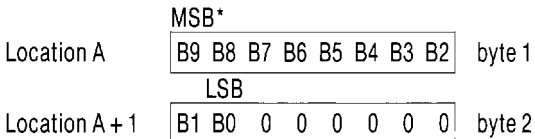

\*B9 is MSB in unipolar or sign bit in bipolar

MNEMONIC	DESCRIPTION
BCLR n	C0 is cleared ( $\overline{CS}$ goes low)
LDA	Load D <sub>IN</sub> for LTC1090 into ACC
STA	Load D <sub>IN</sub> from ACC to SPI data reg. Start SCK
NOP	8 NOPs for timing
LDA	Load contents of SPI status reg. into ACC
LDA	Load LTC1090 D <sub>OUT</sub> from SPI data reg. into ACC (byte 1)
STA	Load LTC1090 D <sub>OUT</sub> into RAM (location A)
STA	Start next SPI cycle
NOP	6 NOPs for timing
BSET n	C0 is set ( $\overline{CS}$ goes high)
LDA	Load contents of SPI status reg. into ACC
LDA	Load LTC1090 D <sub>OUT</sub> from SPI data reg. into ACC (byte 2)
STA	Load LTC1090 D <sub>OUT</sub> into RAM (location A + 1)

### Hitachi Synchronous SCI (HD63705)

The HD63705 transfers serial data in 8-bit increments, LSB first. To accommodate this, the LTC1090 is programmed for 16-bit word length and LSB first format. The 10-bit output data is received by the processor as two 8-bit bytes, LSB first. The LTC1090 fills the final 6 unused bits (after the MSB) with zeroes in unipolar mode and with the sign bit in bipolar mode.

#### Hardware and Software Interface to Hitachi HD63705 Processor

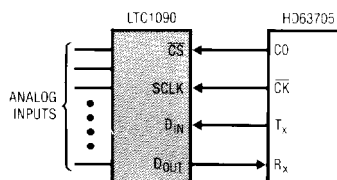

D<sub>OUT</sub> from LTC1090 stored in HD63705 RAM

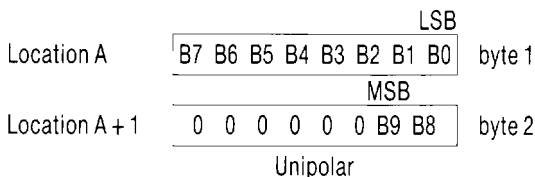
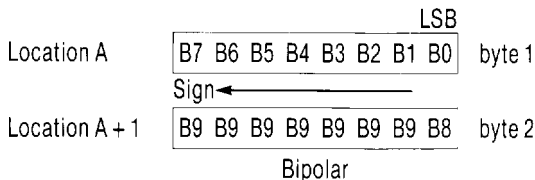

MNEMONIC	DESCRIPTION
LDA	Load D <sub>IN</sub> word for LTC1090 into ACC from RAM
BCLR n	C0 cleared ( $\overline{CS}$ goes low)
STA	Load D <sub>IN</sub> word for LTC1090 into SCI data reg from ACC and start clocking data (LSB first)
NOP	6 NOPs for timing
LDA	Load contents of SCI data reg into ACC (byte 1)
STA	Start next SCI cycle
STA	Load LTC1090 D <sub>OUT</sub> word into RAM (Location A)
NOP	Timing
BSET n	C0 set ( $\overline{CS}$ goes high)
LDA	Load contents of SCI data reg into ACC (byte 2)
STA	Load LTC1090 D <sub>OUT</sub> word into RAM (Location A + 1)



# APPLICATIONS INFORMATION

## Parallel Port Microprocessors

When interfacing the LTC1090 to an MPU which has a parallel port, the serial signals are created on the port with software. Three MPU port lines are programmed to create the CS, SCLK and D<sub>IN</sub> signals for the LTC1090. A fourth port line reads the D<sub>OUT</sub> line. An example is made of the Intel 8051/8052/80C252 family.

### Intel 8051

To interface to the 8051, the LTC1090 is programmed for MSB first format and 10-bit word length. The 8051 generates CS, SCLK and D<sub>IN</sub> on three port lines and reads D<sub>OUT</sub> on the fourth.

### Hardware and Software Interface to Intel 8051 Processor

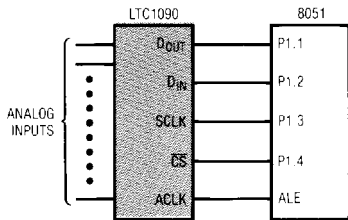

D<sub>OUT</sub> from LTC1090 stored in 8051 RAM

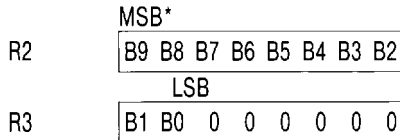

\*B9 is MSB in unipolar or sign bit in bipolar

## 8051 Code

MNEMONIC	DESCRIPTION
MOV P1,#02H	Initialize port 1 (bit 1 is made an input)
CLR P1.3	SCLK goes low
SETB P1.4	CS goes high
CONTINUE: MOV A,#0DH	D <sub>IN</sub> word for the LTC1090 is placed in ACC.
CLR P1.4	CS goes low
MOV R4,#08	Load counter
NOP	Delay for deglitcher
LOOP: MOV C,P1.1	Read data bit into carry
RLC A	Rotate data bit into ACC
MOV P1.2,C	Output D <sub>IN</sub> bit to LTC1090
SETB P1.3	SCLK goes high
CLR P1.3	SCLK goes low
DJNZ R4,LOOP	Next bit
MOV R2,A	Store MSBs in R2
MOV C,P1.1	Read data bit into carry
CLR A	Clear ACC
RLC A	Rotate data bit into ACC
SETB P1.3	SCLK goes high
CLR P1.3	SCLK goes low
MOV C,P1.1	Read data bit into carry
RRC A	Rotate right into ACC
RRC A	Rotate right into ACC
MOV R3,A	Store LSBs in R3
SETB P1.3	SCLK goes high
CLR P1.3	SCLK goes low
SETB P1.4	CS goes high
MOV R5,#07H	Load counter
DELAY: DJNZ R5,DELAY	Delay for LTC1090 to perform conversion
AJMP CONTINUE	Repeat program

## 6. Sharing the Serial Interface

The LTC1090 can share the same 3 wire serial interface with other peripheral components or other LTC1090s (see Figure 5). In this case, the CS signals decide which LTC1090 is being addressed by the MPU.

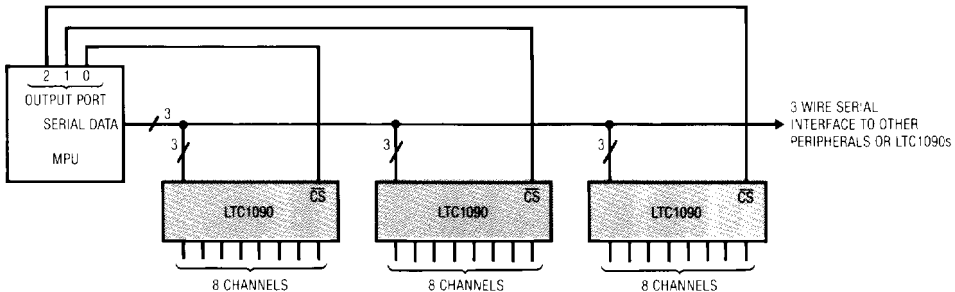

Figure 5. Several LTC1090s Sharing One 3 Wire Serial Interface

## APPLICATIONS INFORMATION

### ANALOG CONSIDERATIONS

#### 1. Grounding

The LTC1090 should be used with an analog ground plane and single point grounding techniques.

Pin 11 (AGND) should be tied directly to this ground plane.

Pin 10 (DGND) can also be tied directly to this ground plane because minimal digital noise is generated within the chip itself.

Pin 20 ( $V_{CC}$ ) should be bypassed to the ground plane with a  $4.7\mu\text{F}$  tantalum with leads as short as possible. Pin 12 ( $V^-$ ) should be bypassed with a  $0.1\mu\text{F}$  ceramic disk. For single supply applications,  $V^-$  can be tied to the ground plane.

It is also recommended that pin 13 ( $\text{REF}^-$ ) and pin 9 (COM) be tied directly to the ground plane. All analog inputs should be referenced directly to the single point ground. Digital inputs and outputs should be shielded from and/or routed away from the reference and analog circuitry.

Figure 6 shows an example of an ideal ground plane design for a two sided board. Of course this much ground plane will not always be possible, but users should strive to get as close to this ideal as possible.

#### 2. Bypassing

For good performance,  $V_{CC}$  must be free of noise and ripple. Any changes in the  $V_{CC}$  voltage with respect to analog ground during a conversion cycle can induce errors or noise in the output code.  $V_{CC}$  noise and ripple can be kept below 1mV by bypassing the  $V_{CC}$  pin directly to the analog ground plane with a  $4.7\mu\text{F}$  tantalum with leads as short as possible. Figures 7 and 8 show the effects of good and poor  $V_{CC}$  bypassing.

#### 3. Analog Inputs

Because of the capacitive redistribution A/D conversion techniques used, the analog inputs of the LTC1090 have capacitive switching input current spikes. These current spikes settle quickly and do not cause a problem.

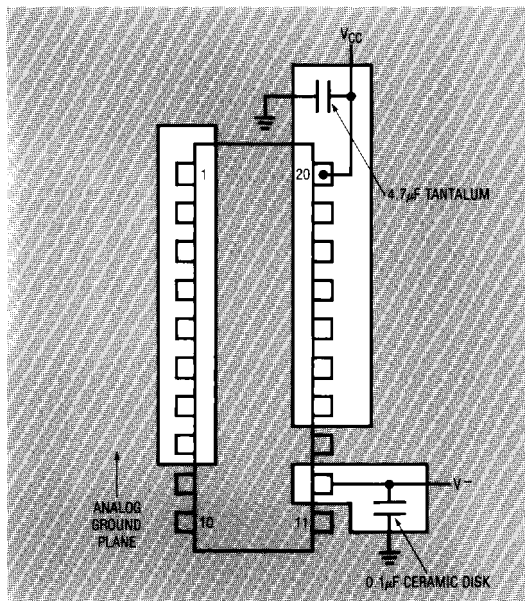

Figure 6. Example Ground Plane for the LTC1090

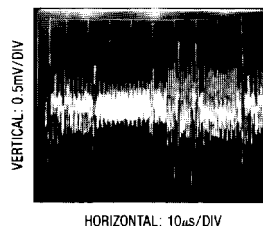

Figure 7. Poor  $V_{CC}$  Bypassing. Noise and Ripple can Cause A/D Errors

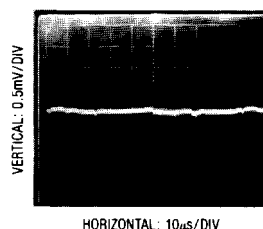

Figure 8. Good  $V_{CC}$  Bypassing Keeps Noise and Ripple on  $V_{CC}$  Below 1mV

## APPLICATIONS INFORMATION

However, if large source resistances are used or if slow settling op amps drive the inputs, care must be taken to insure that the transients caused by the current spikes settle completely before the conversion begins.

### Source Resistance

The analog inputs of the LTC1090 look like a 60pF capacitor ( $C_{IN}$ ) in series with a 500 $\Omega$  resistor ( $R_{ON}$ ) as shown in Figure 9.  $C_{IN}$  gets switched between the selected “+” and “-” inputs once during each conversion cycle. Large external source resistors and capacitances will slow the settling of the inputs. It is important that the overall RC time constants be short enough to allow the analog inputs to completely settle within the allowed time.

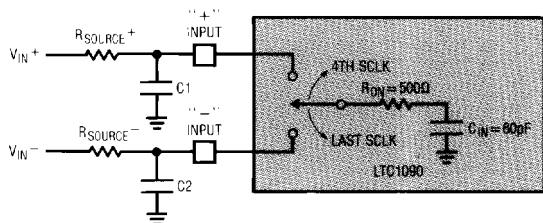

Figure 9. Analog Input Equivalent Circuit

### “+” Input Settling

This input capacitor is switched onto the “+” input during the sample phase ( $t_{SMPL}$ , see Figure 10). The sample phase starts at the 4th SCLK cycle and lasts until the falling edge of the last SCLK (the 8th, 10th, 12th or 16th SCLK cycle depending on the selected word length). The voltage on the “+” input must settle completely within this sample time. Minimizing  $R_{SOURCE+}$  and  $C1$  will improve the input settling time. If large “+” input source resistance must be used, the sample time can be increased by using a slower SCLK frequency or selecting a longer word length. With the minimum possible sample time of 4 $\mu$ s,  $R_{SOURCE+} < 2k\Omega$  and  $C1 < 20pF$  will provide adequate settling.

### “-” Input Settling

At the end of the sample phase the input capacitor switches to the “-” input and the conversion starts (see Figure 10). During the conversion, the “+” input voltage is effectively “held” by the sample and hold and will not affect the conversion result. However, it is critical that the “-” input voltage be free of noise and settle completely during the first four ACLK cycles of the conversion time. Minimizing  $R_{SOURCE-}$  and  $C2$  will improve settling time. If large “-” input source resistance must be used, the time allowed for settling can be extended by using a slower ACLK frequency. At the maximum ACLK rate of 2MHz,  $R_{SOURCE-} < 1k\Omega$  and  $C2 < 20pF$  will provide adequate settling.

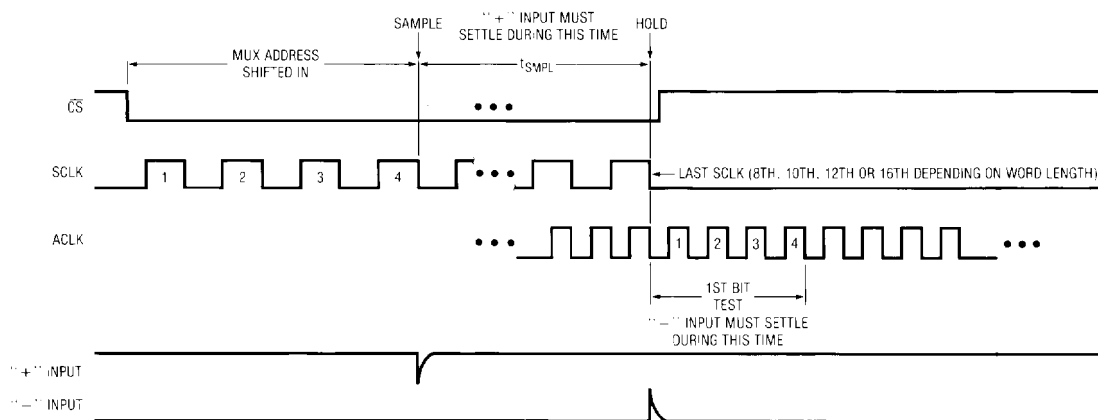

Figure 10. “+” and “-” Input Settling Windows

## APPLICATIONS INFORMATION

### Input Op Amps

When driving the analog inputs with an op amp it is important that the op amp settle within the allowed time (see Figure 10). Again, the “+” and “-” input sampling times can be extended as described above to accommodate slower op amps. Most op amps including the LT1006 and LT1013 single supply op amps can be made to settle well even with the minimum settling windows of  $4\mu\text{s}$  (“+” input) and  $2\mu\text{s}$  (“-” input) which occur at the maximum clock rates ( $\text{ACLK} = 2\text{MHz}$  and  $\text{SCLK} = 1\text{MHz}$ ). Figures 11 and 12 show examples of adequate and poor op amp settling.

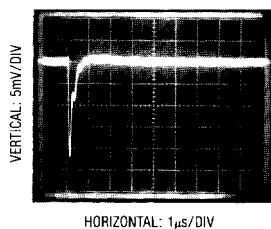

Figure 11. Adequate Settling of Op Amp Driving Analog Input

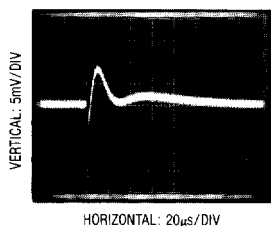

Figure 12. Poor Op Amp Settling can Cause A/D Errors

### RC Input Filtering

It is possible to filter the inputs with an RC network as shown in Figure 13. For large values of  $C_F$  (e.g.,  $1\mu\text{F}$ ), the capacitive input switching currents are averaged into a net DC current. Therefore, a filter should be chosen with a small resistor and large capacitor to prevent DC drops across the resistor. The magnitude of the DC current is approximately  $I_{DC} = 60\text{pF} \times V_{IN}/t_{CYC}$  and is roughly proportional to  $V_{IN}$ . When running at the minimum cycle time of  $33\mu\text{s}$ , the input current equals  $9\mu\text{A}$  at  $V_{IN} = 5\text{V}$ . In this case, a filter resistor of  $50\Omega$  will cause  $0.1\text{LSB}$  of full-scale error. If a larger filter resistor must be used, errors can be elim-

inated by increasing the cycle time as shown in the typical curve of Maximum Filter Resistor vs Cycle Time.

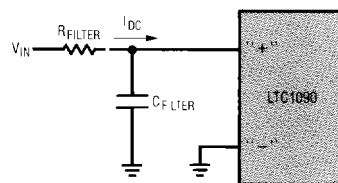

Figure 13. RC Input Filtering

### Input Leakage Current

Input leakage currents can also create errors if the source resistance gets too large. For instance, the maximum input leakage specification of  $1\mu\text{A}$  (at  $125^\circ\text{C}$ ) flowing through a source resistance of  $1\text{k}\Omega$  will cause a voltage drop of  $1\text{mV}$  or  $0.2\text{LSB}$ . This error will be much reduced at lower temperatures because leakage drops rapidly (see typical curve of Input Channel Leakage Current vs Temperature).

### Noise Coupling into Inputs

High source resistance input signals ( $>500\Omega$ ) are more sensitive to coupling from external sources. It is preferable to use channels near the center of the package (i.e., CH2-CH7) for signals which have the highest output resistance because they are essentially shielded by the pins on the package ends (DGND and CH0). Grounding any unused inputs (especially the end pin, CH0) will also reduce outside coupling into high source resistances.

## 4. Sample and Hold

### Single Ended Inputs

The LTC1090 provides a built-in sample and hold (S&H) function for all signals acquired in the single ended mode (COM pin grounded). This sample and hold allows the LTC1090 to convert rapidly varying signals (see typical curve of S&H Acquisition Time vs Source Resistance). The input voltage is sampled during the  $t_{SMP_L}$  time as shown in Figure 10. The sampling interval begins after the fourth MUX address bit is shifted in and continues during the remainder of the data transfer. On the falling edge of the

## APPLICATIONS INFORMATION

final SCLK, the S&H goes into hold mode and the conversion begins. The voltage will be held on either the 8th, 10th, 12th or 16th falling edge of the SCLK depending on the word length selected.

### Differential Inputs

With differential inputs or when the COM pin is not tied to ground, the A/D no longer converts just a single voltage but rather the difference between two voltages. In these cases, the voltage on the selected “+” input is still sampled and held and therefore may be rapidly time varying just as in single ended mode. However, the voltage on the selected “-” input must remain constant and be free of noise and ripple throughout the conversion time. Otherwise, the differencing operation may not be performed accurately. The conversion time is 44 ACLK cycles. Therefore, a change in the “-” input voltage during this interval can cause conversion errors. For a sinusoidal voltage on the “-” input this error would be:

$$V_{\text{ERROR (MAX)}} = V_{\text{PEAK}} \times 2 \times \pi \times f(\text{“-”}) \times 44/f_{\text{ACLK}}$$

Where  $f(\text{“-”})$  is the frequency of the “-” input voltage,  $V_{\text{PEAK}}$  is its peak amplitude and  $f_{\text{ACLK}}$  is the frequency of the ACLK. In most cases  $V_{\text{ERROR}}$  will not be significant. For a 60Hz signal on the “-” input to generate a 1/4LSB error (1.25mV) with the converter running at  $\text{ACLK} = 2\text{MHz}$ , its peak value would have to be 150mV.

### 5. Reference Inputs

The voltage between the reference inputs of the LTC1090 defines the voltage span of the A/D converter. The reference inputs look primarily like a 10k $\Omega$  resistor but will have transient capacitive switching currents due to the switched capacitor conversion technique (see Figure 14). During each bit test of the conversion (every 4 ACLK cycles), a capacitive current spike will be generated on the reference pins by the A/D. These current spikes settle quickly and do not cause a problem. However, if slow settling circuitry is used to drive the reference inputs, care must be taken to insure that transients caused by these current spikes settle completely during each bit test of the conversion.

When driving the reference inputs, three things should be kept in mind:

1. The source resistance ( $R_{\text{OUT}}$ ) driving the reference inputs should be low (less than 1 $\Omega$ ) to prevent DC drops caused by the 1mA maximum reference current ( $I_{\text{REF}}$ ).
2. Transients on the reference inputs caused by the capacitive switching currents must settle completely during each bit test (each 4 ACLK cycles). Figures 15 and 16 show examples of both adequate and poor settling. Using a slower ACLK will allow more time for the reference to settle. However, even at the maximum ACLK rate of 2MHz most references and op amps can be made to settle within the 2 $\mu\text{s}$  bit time.
3. It is recommended that the REF- input be tied directly to the analog ground plane. If REF- is biased at a voltage other than ground, the voltage must not change during a conversion cycle. This voltage must also be free of noise and ripple with respect to analog ground.

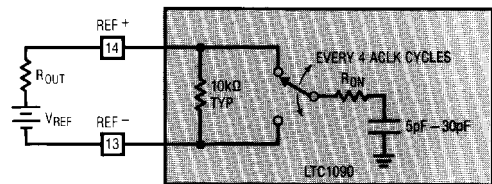

Figure 14. Reference Input Equivalent Circuit

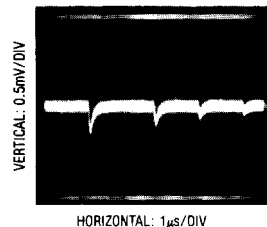

Figure 15. Adequate Reference Settling

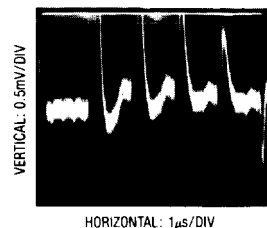

Figure 16. Poor Reference Settling Can Cause A/D Errors

## APPLICATIONS INFORMATION

### 6. Reduced Reference Operation

The effective resolution of the LTC1090 can be increased by reducing the input span of the converter. The LTC1090 exhibits good linearity and gain over a wide range of reference voltages (see typical curves of Linearity and Gain Error vs Reference Voltage). However, care must be taken when operating at low values of  $V_{REF}$  because of the reduced LSB step size and the resulting higher accuracy requirement placed on the converter. The following factors must be considered when operating at low  $V_{REF}$  values.

1. Conversion speed (ACLK frequency)
2. Offset
3. Noise

#### Conversion Speed with Reduced $V_{REF}$

With reduced reference voltages, the LSB step size is reduced and the LTC1090 internal comparator overdrive is reduced. With less overdrive, more time is required to perform a conversion. Therefore, the maximum ACLK frequency should be reduced when low values of  $V_{REF}$  are used. This is shown in the typical curve of Maximum Conversion Clock Rate vs Reference Voltage.

#### Offset with Reduced $V_{REF}$

The offset of the LTC1090 has a larger effect on the output code when the A/D is operated with reduced reference voltage. The offset (which is typically a fixed voltage) becomes a larger fraction of an LSB as the size of the LSB is reduced. The typical curve of Unadjusted Offset Error vs Reference Voltage shows how offset in LSBs is related to reference voltage for a typical value of  $V_{OS}$ . For example, a  $V_{OS}$  of 0.5mV which is 0.1LSB with a 5V reference be-

comes 0.5LSB with a 1V reference and 2.5LSBs with a 0.2V reference. If this offset is unacceptable, it can be corrected digitally by the receiving system or by offsetting the “-” input to the LTC1090.

#### Noise with Reduced $V_{REF}$

The total input referred noise of the LTC1090 can be reduced to approximately 200 $\mu$ V peak-to-peak using a ground plane, good bypassing, good layout techniques and minimizing noise on the reference inputs. This noise is insignificant with a 5V reference but will become a larger fraction of an LSB as the size of the LSB is reduced. The typical curve of Noise Error vs Reference Voltage shows the LSB contribution of this 200 $\mu$ V of noise.

For operation with a 5V reference, the 200 $\mu$ V noise is only 0.04LSB peak-to-peak. In this case, the LTC1090 noise will contribute virtually no uncertainty to the output code. However, for reduced references, the noise may become a significant fraction of an LSB and cause undesirable jitter in the output code. For example, with a 1V reference, this same 200 $\mu$ V noise is 0.2LSB peak-to-peak. This will reduce the range of input voltages over which a stable output code can be achieved by 0.2LSB. If the reference is further reduced to 200mV, the 200 $\mu$ V noise becomes equal to one LSB and a stable code may be difficult to achieve. In this case averaging readings may be necessary.

This noise data was taken in a very clean setup. Any setup induced noise (noise or ripple on  $V_{CC}$ ,  $V_{REF}$ ,  $V_{IN}$  or  $V^-$ ) will add to the internal noise. The lower the reference voltage to be used, the more critical it becomes to have a clean, noise-free setup.

## TYPICAL APPLICATIONS

### A “Quick Look” Circuit for the LTC1090

Users can get a quick look at the function and timing of the LTC1090 by using the following simple circuit. REF<sup>+</sup> and D<sub>IN</sub> are tied to  $V_{CC}$  selecting a 5V input span, CH7 as a single ended input, unipolar mode, MSB first format and 16-bit word length. ACLK and SCLK are tied together and

driven by an external clock.  $\overline{CS}$  is driven at 1/64 the clock rate by the CD4520 and D<sub>OUT</sub> outputs the data. All other pins are tied to a ground plane. The output data from the D<sub>OUT</sub> pin can be viewed on an oscilloscope which is set up to trigger on the falling edge of  $\overline{CS}$ .

## TYPICAL APPLICATIONS

A "Quick Look" Circuit for the LTC1090

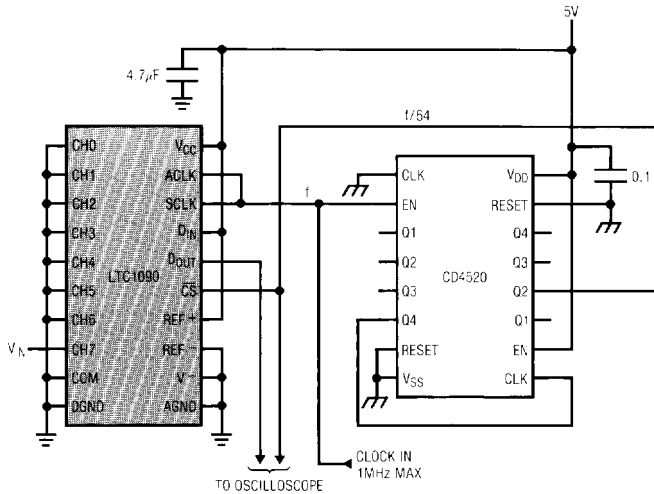

Scope Trace of LTC1090 "Quick Look" Circuit Showing A/D Output of 0101010101 (155<sub>HEX</sub>)

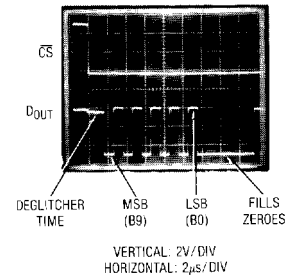

### SNEAK-A-BIT™

The LTC1090's unique ability to software select the polarity of the differential inputs and the output word length is used to achieve one more bit of resolution. Using the circuit below with two conversions and some software, a 2's complement 10-bit + sign word is returned to memory inside the MPU. The MC68HC05C4 was chosen as an example; however, any processor could be used.

Two 10-bit unipolar conversions are performed: the first over a 0 to 5V span and the second over a 0 to -5V span (by reversing the polarity of the inputs). The sign of the input is determined by which of the two spans contained it. Then the resulting number (ranging from -1023 to +1023 decimal) is converted to 2's complement notation and stored in RAM.

SNEAK-A-BIT Circuit

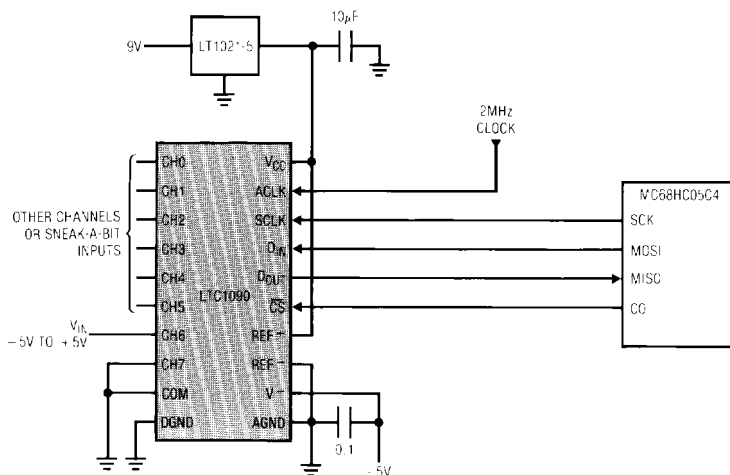

SNEAK-A-BIT is a trademark of Linear Technology Corp.

# TYPICAL APPLICATIONS

## SNEAK-A-BIT

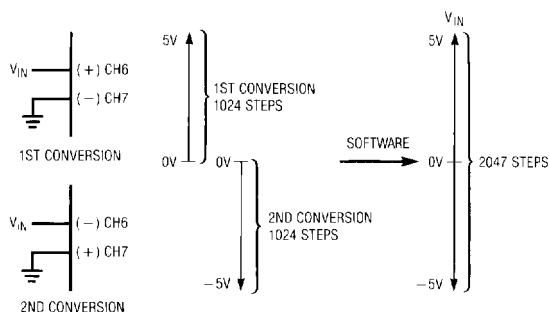

### SNEAK-A-BIT Code

$D_{OUT}$  from LTC1090 in MC68HC05C4 RAM

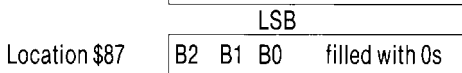
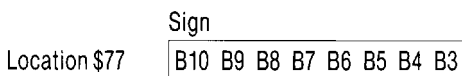

$D_{IN}$  words for LTC1090

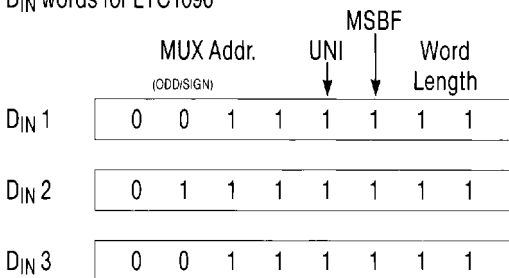

### Sneak-A-Bit Code for the LTC1090 Using the MC68HC05C4

MNEMONIC	DESCRIPTION
LDA #50	Configuration data for SPCR
STA \$0A	Load configuration data into \$0A
LDA #5FF	Configuration data for port C DDR
STA \$06	Load configuration data into port C DDR
BSET 0, \$02	Make sure CS is high
JSR READ -/+	Dummy read configures LTC1090 for next read
JSR READ +/-	Read CH6 with respect to CH7
JSR READ -/+	Read CH7 with respect to CH6
JSR CHK SIGN	Determines which reading has valid data, converts to 2's complement and stores in RAM

### Sneak-A-Bit Code for the LTC1090 Using the MC68HC05C4

MNEMONIC	DESCRIPTION
READ -/+ : LDA #3F	Load $D_{IN}$ word for LTC1090 into ACC
JSR TRANSFER	Read LTC1090 routine
LDA \$60	Load MSBs from LTC1090 into ACC
STA \$71	Store MSBs in \$71
LDA \$61	Load LSBs from LTC1090 into ACC
STA \$72	Store LSBs in \$72
RTS	Return
READ +/- : LDA #57F	Load $D_{IN}$ word for LTC1090 into ACC
JSR TRANSFER	Read LTC1090 routine
LDA \$60	Load MSBs from LTC1090 into ACC
STA \$73	Store MSBs in \$73
LDA \$61	Load LSBs from LTC1090 into ACC
STA \$74	Store LSBs in \$74
RTS	Return
TRANSFER: BCLR 0, \$02	CS goes low
STA \$0C	Load $D_{IN}$ into SPI. Start transfer
LOOP 1: TST \$0B	Test status of SPIF
BPL LOOP 1	Loop to previous instruction if not done
LDA \$0C	Load contents of SPI data reg into ACC
STA \$0C	Start next cycle
STA \$60	Store MSBs in \$60
LOOP 2: TST \$0B	Test status of SPIF
BPL LOOP 2	Loop to previous instruction if not done
BSET 0, \$02	CS goes high
LDA \$0C	Load contents of SPI data reg into ACC
STA \$61	Store LSBs in \$61
RTS	Return
CHK SIGN: LDA \$73	Load MSBs of +/- read into ACC
ORA \$74	Or ACC (MSBs) with LSBs of +/- read
BEQ MINUS	If result is 0 goto minus
CLC	Clear carry
ROR \$73	Rotate right \$73 through carry
ROR \$74	Rotate right \$74 through carry
LDA \$73	Load MSBs of +/- read into ACC
STA \$77	Store MSBs in RAM location \$77
LDA \$74	Load LSBs of +/- read into ACC
STA \$87	Store LSBs in RAM location \$87
BRA END	Goto end of routine
MINUS: CLC	Clear carry
ROR \$71	Shift MSBs of +/- read right
ROR \$72	Shift LSBs of +/- read right
COM \$71	1's complement of MSBs
COM \$72	1's complement of LSBs
LDA \$72	Load LSBs into ACC
ADD #01	Add 1 to LSBs
STA \$72	Store ACC in \$72
CLRA	Clear ACC
ADC \$71	Add with carry to MSBs. Result in ACC
STA \$71	Store ACC in \$71
STA \$77	Store MSBs in RAM location \$77
LDA \$72	Load LSBs in ACC
STA \$87	Store LSBs in RAM location \$87
END: RTS	Return



**PACKAGE DESCRIPTION** Dimensions in inches (millimeters) unless otherwise noted.

**J Package**  
20-Lead Ceramic DIP

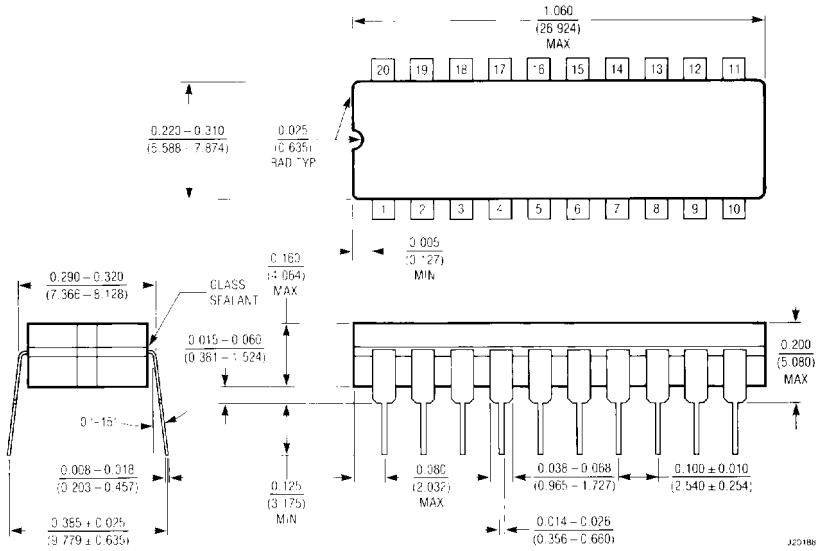

$T_{jmax}$ 150°C	$\theta_{JA}$ 70°C/CW
---------------------	--------------------------

**N Package**  
20-Lead Molded DIP

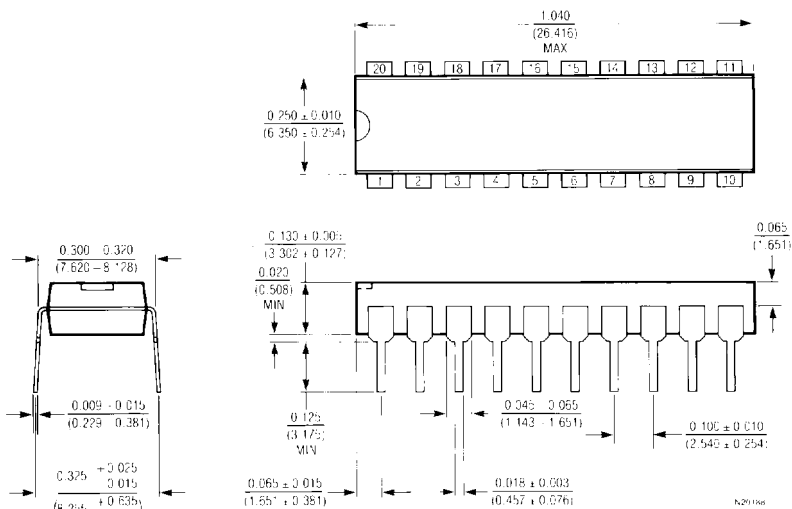

$T_{jmax}$ 110°C	$\theta_{JA}$ 90°C/CW
---------------------	--------------------------

The specifications for the **LTC<sup>®</sup>1090CS** are identical to those of the **LTC1090CN**. For complete specifications, typical performance curves and applications information, please see the **LTC1090** data sheet.

LT, LTC and LT are registered trademarks of Linear Technology Corporation.

## PACKAGE/ORDER INFORMATION

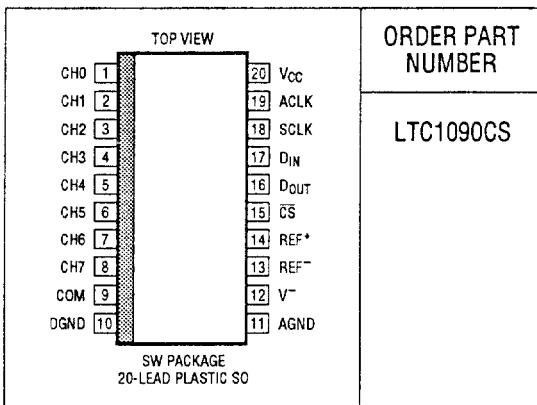

For further information regarding this specification notice contact:

Linear Technology Corporation  
 1630 McCarthy Blvd.  
 Milpitas, California 95035-7417  
 Attn: Product Marketing Manager  
 Phone: (408) 432-1900