

Low Noise, High Efficiency, Inductorless Step-Down DC/DC Converter

August 2002

FEATURES

- Low Noise Constant Frequency Operation
- 2.7V to 5.5V Input Voltage Range
- No Inductors
- Typical Efficiency 25% Higher Than LDOs
- Shutdown Disconnects Load from V_{IN}
- Output Voltage: $1.8V \pm 4\%$ or $1.5V \pm 4\%$
- Output Current: 250mA
- Low Operating Current: $I_{IN} = 180\mu A$ Typ
- Low Shutdown Current: $I_{IN} = 10\mu A$ Typ
- Oscillator Frequency: 1.5MHz
- Soft-Start Limits Inrush Current at Turn On
- Short-Circuit and Overtemperature Protected
- Available in an 8-Pin MSOP Package

APPLICATIONS

- Handheld Computers
- Cellular Phones
- Smart Card Readers
- Portable Electronic Equipment
- Handheld Medical Instruments
- Low Power DSP Supplies

LT, LTC and LT are registered trademarks of Linear Technology Corporation.
 Burst Mode is a trademark of Linear Technology Corporation.

DESCRIPTION

The LTC[®]1911 is a switched capacitor step-down DC/DC converter that produces a 1.5V or 1.8V regulated output from a 2.7V to 5.5V input. The part uses switched capacitor fractional conversion to achieve high efficiency over the entire input range. No inductors are required. Internal circuitry controls the step-down conversion ratio to optimize efficiency as the input voltage and load conditions vary. Typical efficiency is over 25% higher than that of a linear regulator.

A unique constant frequency architecture provides a low noise regulated output as well as lower input noise than conventional charge pump regulators. High frequency operation ($f_{OSC} = 1.5MHz$) simplifies output filtering to further reduce conducted noise. To optimize efficiency, the part enters Burst Mode[™] operation under light load conditions.

Low operating current (180 μA with no load, 10 μA in shutdown) and low external parts count (two 1 μF flying capacitors and two 10 μF bypass capacitors) make the LTC1911 ideally suited for space constrained battery-powered applications. The part is short-circuit and overtemperature protected, and is available in an 8-pin MSOP package.

TYPICAL APPLICATION

Single Cell Li-Ion to 1.8V DC/DC Converter

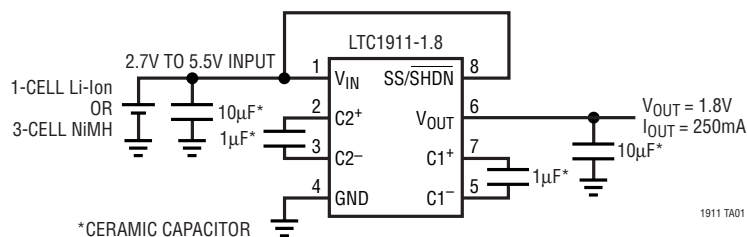

Efficiency

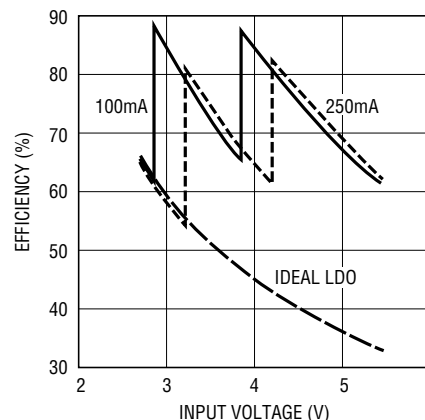

1911 G05

sn1911 1911is

LTC1911-1.5/LTC1911-1.8

ABSOLUTE MAXIMUM RATINGS

(Note 1)

V_{IN} to GND	-0.3V to 6V
SS/SHDN to GND	-0.3V to ($V_{IN} + 0.3V$)
V_{OUT} Short-Circuit Duration	Indefinite
Operating Temperature Range (Note 2) ..	-40°C to 85°C
Storage Temperature Range	-40°C to 150°C
Lead Temperature (Soldering, 10 sec)	300°C

PACKAGE/ORDER INFORMATION

	ORDER PART NUMBER
	LTC1911EMS8-1.5 LTC1911EMS8-1.8
	MS8 PART MARKING
	LTMY LTNU

Consult LTC Marketing for parts specified with wider operating temperature ranges.

ELECTRICAL CHARACTERISTICS

The ● denotes specifications which apply over the full operating temperature range, otherwise specifications are $T_A = 25^\circ\text{C}$. $V_{IN} = 3.6\text{V}$, $C1 = 1\mu\text{F}$, $C2 = 1\mu\text{F}$, $C_{IN} = 10\mu\text{F}$, $C_{OUT} = 10\mu\text{F}$ unless otherwise noted.

PARAMETER	CONDITIONS	MIN	TYP	MAX	UNITS
V_{IN} Operating Voltage		● 2.7		5.5	V
V_{OUT}	LTC1911-1.5, $0\text{mA} \leq I_{OUT} \leq 250\text{mA}$, $V_{IN} = 2.7\text{V}$ to 5.5V	● 1.44	1.5	1.56	V
	LTC1911-1.8, $0\text{mA} \leq I_{OUT} \leq 250\text{mA}$, $V_{IN} = 2.7\text{V}$ to 5.5V	● 1.73	1.8	1.87	V
V_{IN} Operating Current	$I_{OUT} = 0\text{mA}$, $V_{IN} = 2.7\text{V}$ to 5.5V	●	180	350	μA
V_{IN} Shutdown Current	SS/SHDN = 0V, $V_{IN} = 2.7\text{V}$ to 5.5V	●	10	20	μA
Output Ripple (Not Including ESR Spike)	$I_{OUT} = 10\text{mA}$		5		mV _{p-p}
	$I_{OUT} = 250\text{mA}$		12		mV _{p-p}
V_{OUT} Short-Circuit Current	$V_{OUT} = 0\text{V}$		600		mA
Switching Frequency	Oscillator Free Running	1.2	1.5	1.8	MHz
SS/SHDN Input Threshold		● 0.3	0.6	1	V
SS/SHDN Soft-Start Current	$V_{SS/SHDN} = 0\text{V}$ (Note 3) $V_{SS/SHDN} = V_{IN}$	● -5	-2	-1	μA
			0.01		μA
Turn-On Time	$C_{SS} = 0\text{pF}$, $V_{IN} = 3.3\text{V}$ $C_{SS} = 10\text{nF}$, $V_{IN} = 3.3\text{V}$		0.03		ms
			10		ms
Load Regulation	$0\text{V} \leq I_{OUT} \leq 250\text{mA}$		0.13		mV/mA
Line Regulation	$0\text{V} \leq I_{OUT} \leq 250\text{mA}$		0.3		%/V

Note 1: Absolute Maximum Ratings are those values beyond which the life of a device may be impaired.

Note 2: The LTC1911E is guaranteed to meet specified performance from 0°C to 70°C. Specifications over the -40°C to 85°C operating temperature range are assured by design, characterization and correlation with statistical process control.

Note 3: Currents flowing into the device are positive polarity. Currents flowing out of the device are negative polarity.

TYPICAL PERFORMANCE CHARACTERISTICS

Input Operating Current vs Input Voltage

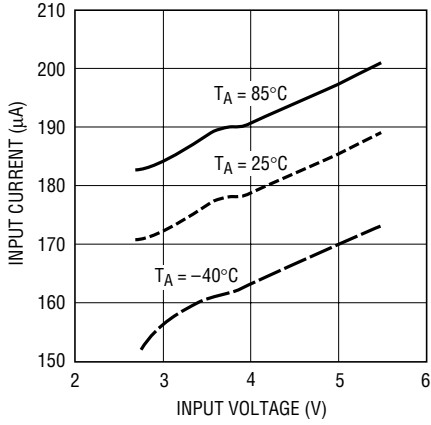

1911 G01

Input Shutdown Current vs Input Voltage

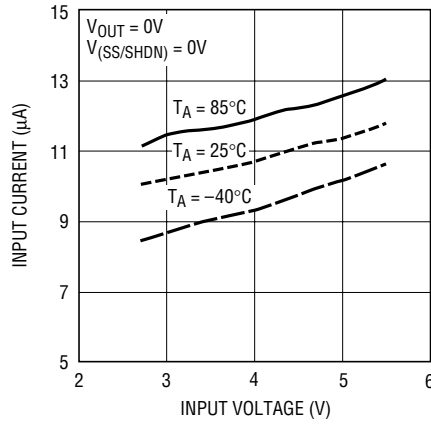

1911 G02

LTC1911-1.8 Output Voltage vs Input Voltage

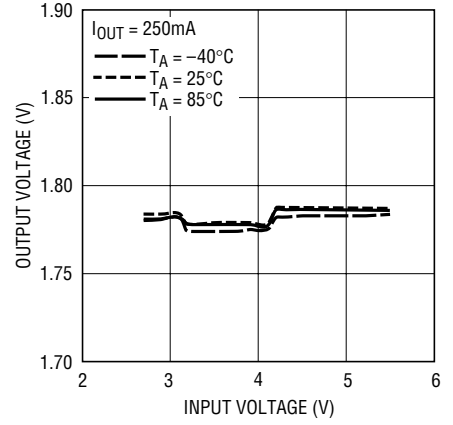

1911 G03

LTC1911-1.5 Output Voltage vs Input Voltage

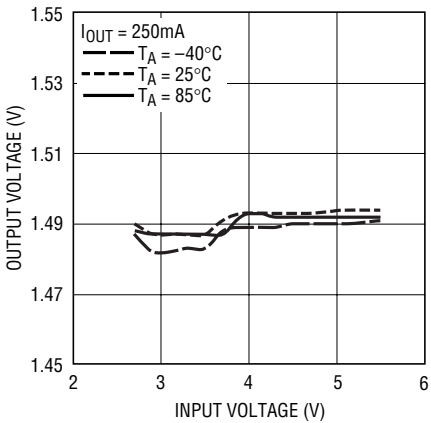

LTXXXX • TPCXX

LTC1911-1.5 Efficiency vs Input Voltage (Falling Input Voltage)

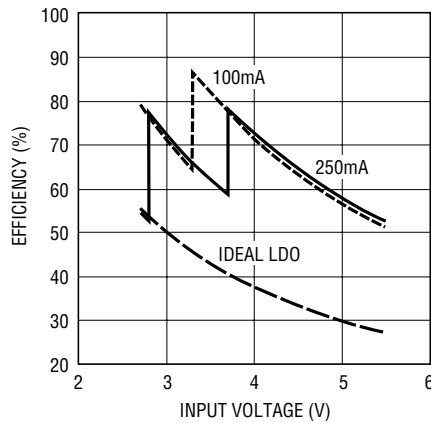

1911 G05

LTC1911-1.8 Efficiency vs Output Current

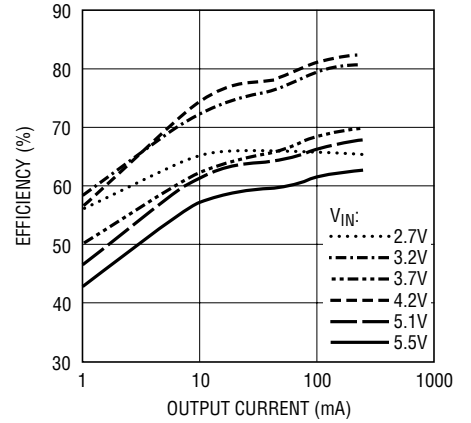

1911 G06

LTC1911-1.5 Efficiency vs Output Current

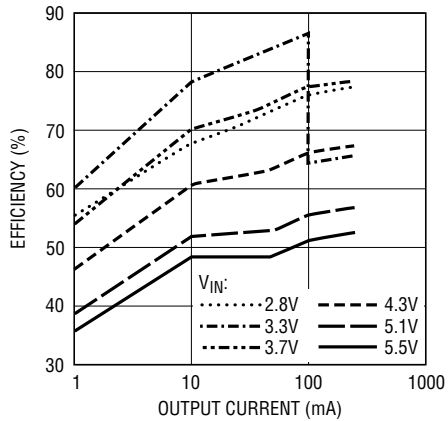

1911 G07

LTC1911-1.8 Output Voltage vs Output Current

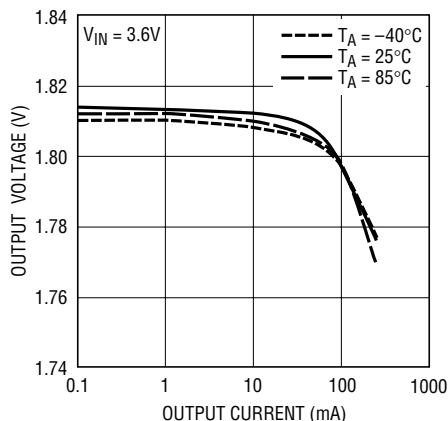

1911 G08

LTC1911-1.5 Output Voltage vs Output Current

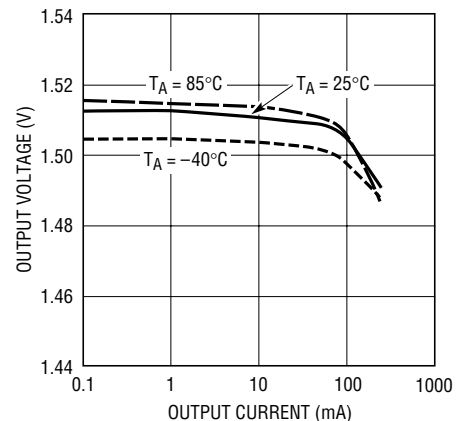

1911 G09

TYPICAL PERFORMANCE CHARACTERISTICS

Start-Up Time vs Soft-Start Capacitor

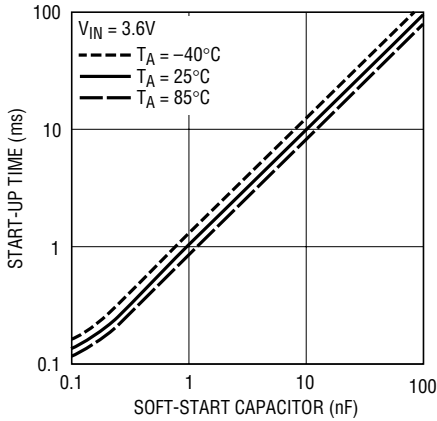

1911 G10

Output Ripple vs Output Load Current

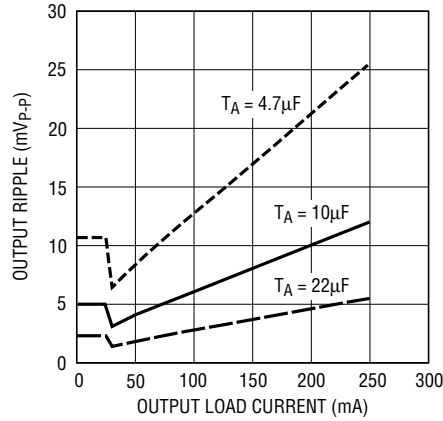

1911 G11

Oscillator Frequency vs Supply Voltage

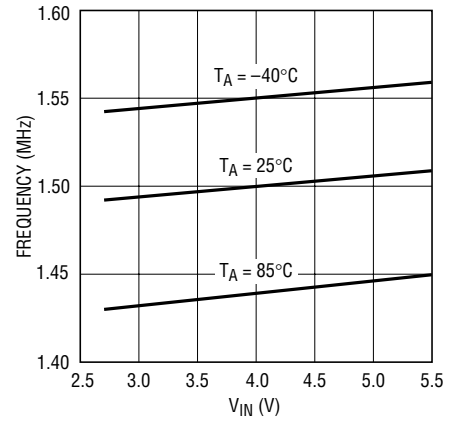

1911 G15

LTC1911-1.8 Output Voltage Ripple

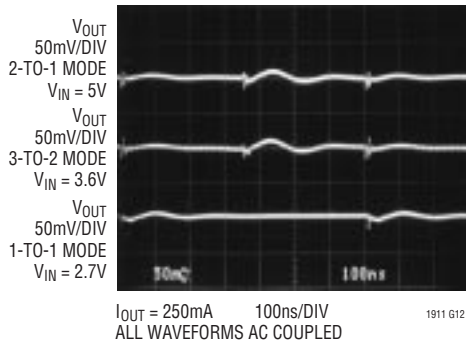

1911 G12

Output Current Transient Response

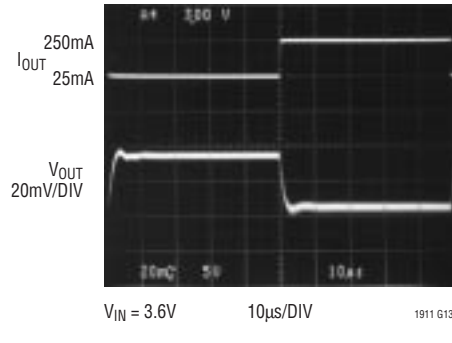

1911 G13

Line Transient Response

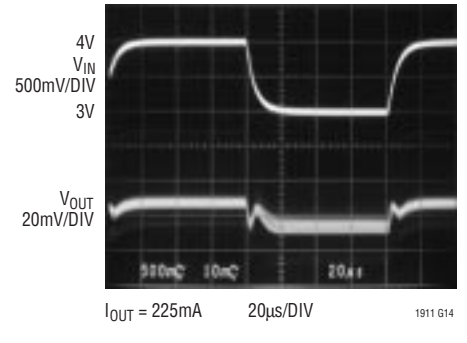

1911 G14

PIN FUNCTIONS

V_{IN} (Pin 1): Input Supply Voltage. V_{IN} may be between 2.7V and 5.5V. Suggested bypass for V_{IN} is a 10µF (1µF min) ceramic low ESR capacitor.

C2⁺ (Pin 2): Flying Capacitor Two Positive Terminal.

C2⁻ (Pin 3): Flying Capacitor Two Negative Terminal.

GND (Pin 4): Ground. Connect to a ground plane for best performance.

C1⁻ (Pin 5): Flying Capacitor One Negative Terminal.

V_{OUT} (Pin 6): Regulated Output Voltage. V_{OUT} is disconnected from V_{IN} during shutdown. Bypass V_{OUT} with a ≥ 10µF ceramic low ESR capacitor (4µF min, ESR < 0.1Ω max).

C1⁺ (Pin 7): Flying Capacitor One Positive Terminal.

SS/SHDN (Pin 8): Soft-Start/Shutdown Control Pin. This pin is designed to be driven with an external open-drain output. Holding the SS/SHDN pin below 0.3V will force the LTC1911-X into shutdown mode. An internal pull-up current of 2µA will force the SS/SHDN voltage to climb to V_{IN} once the device driving the pin is forced into a Hi-Z state. To limit inrush current on start-up, connect a capacitor between the SS/SHDN pin and GND. Capacitance on the SS/SHDN pin will limit the dV/dt of the pin during turn on which, in turn, will limit the dV/dt of V_{OUT}. By selecting an appropriate soft-start capacitor, the user can control the inrush current for a known output capacitor during turn-on (see Application Information). If neither of the two functions are desired, the pin may be left floating or tied to V_{IN}.

sn1911 1911is

SIMPLIFIED BLOCK DIAGRAM

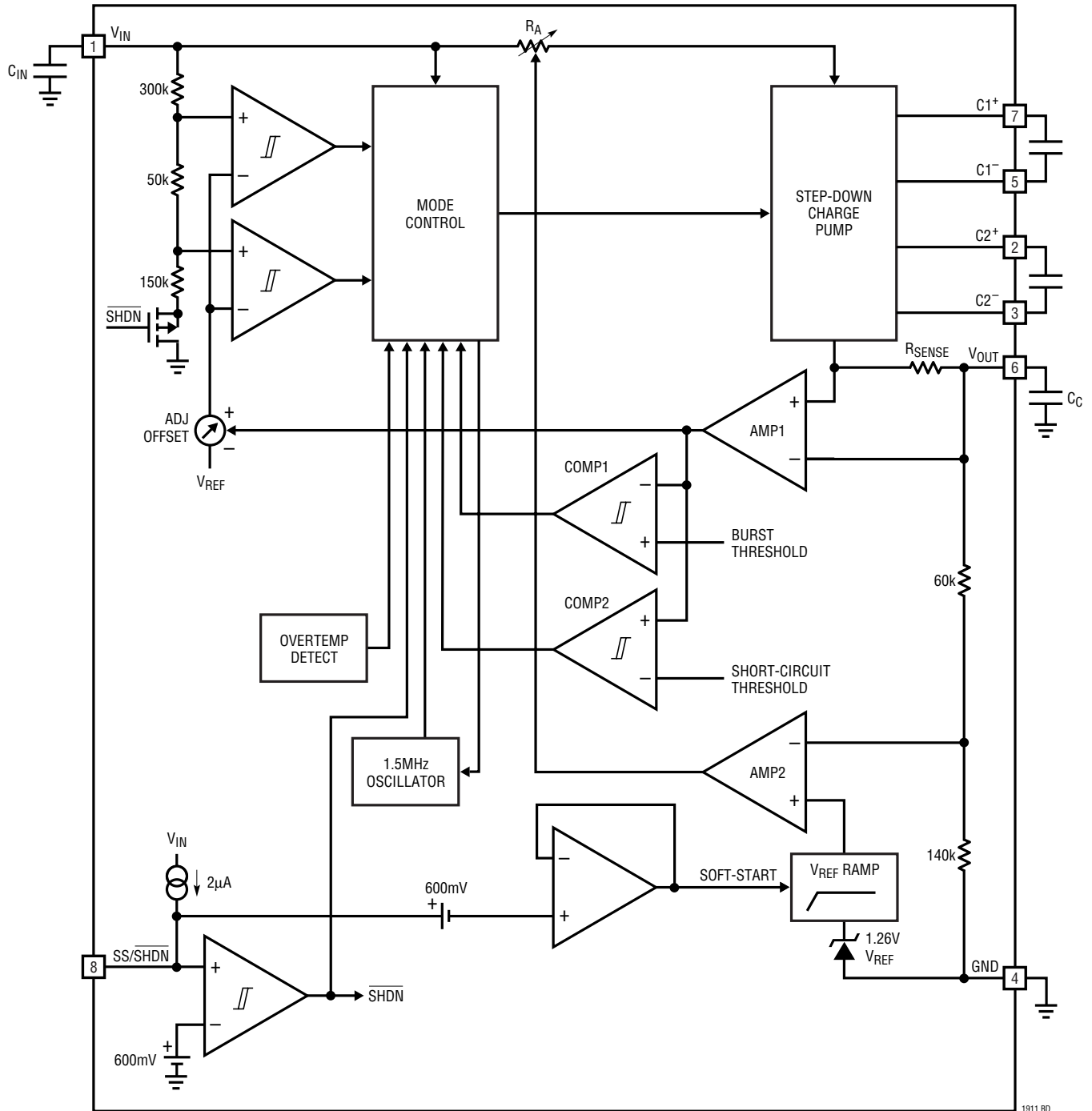

1911 BD

APPLICATIONS INFORMATION

General Operation

The LTC1911 uses a switch capacitor-based DC/DC conversion to provide the efficiency advantages associated with inductor-based circuits as well as the cost and simplicity advantages of a linear regulator. The LTC1911's unique constant frequency architecture provides a low noise regulated output as well as lower input noise than conventional switch-capacitor charge pump regulators.

The LTC1911 uses an internal switch network and fractional conversion ratios to achieve high efficiency over widely varying V_{IN} and output load conditions. Internal control circuitry selects the appropriate step-down conversion ratio based on V_{IN} and load conditions to optimize efficiency. The part has three possible step-down modes: 2-to-1, 3-to-2 or 1-to-1 step-down mode. Only two external flying caps are needed to operate in all three modes. 2-to-1 mode is chosen when V_{IN} is greater than two times the desired V_{OUT} . 3-to-2 mode is chosen when V_{IN} is greater than 1.5 times V_{OUT} but less than 2 times V_{OUT} . 1-to-1 mode is chosen when V_{IN} falls below 1.5 times V_{OUT} . An internal load current sense circuit controls the switch point of the step-down ratio as needed to maintain output regulation over all load conditions.

Regulation is achieved by sensing the output voltage and regulating the amount of charge transferred per cycle. *This method of regulation provides much lower input and output ripple than that of conventional switched capacitor charge pumps.* The constant frequency charge transfer also makes additional output or input filtering much less demanding than conventional switched capacitor charge pumps.

The LTC1911 also has a Burst Mode function that delivers a minimum amount of charge for one cycle then goes into a low current state until the output drops enough to require another burst of charge. Burst Mode operation allows the LTC1911 to achieve high efficiency even at light loads. The part has shutdown capability as well as user-controlled inrush current limiting. In addition, the part has short-circuit and overtemperature protection.

Step-Down Charge Transfer Operation

Figure 1a shows the switch configuration that is used for 2-to-1 step down mode. In this mode, a 2-phase clock generates the switch control signals. On phase one of the clock, the top plate of C1 is connected to V_{IN} through R_A and S4, the bottom plate is connected to V_{OUT} through S3. The amount of charge transferred to C1 (and V_{OUT}) is set by the value of R_A .

On phase two, flying capacitor C1 is connected to V_{OUT} through S1 and to GND through S2. The charge that was transferred onto C1 from the previous cycle is now transferred to the output. Thus, in 2-to-1 mode, charge is transferred to V_{OUT} on both phases of the clock. Since charge current is sourced from GND on the second phase of the clock, current multiplication is realized with respect to V_{IN} , i.e., I_{OUT} equals approximately $2 \cdot I_{IN}$. This results in significant efficiency improvement relative to a linear regulator. The value of R_A is set by the control loop of the regulator.

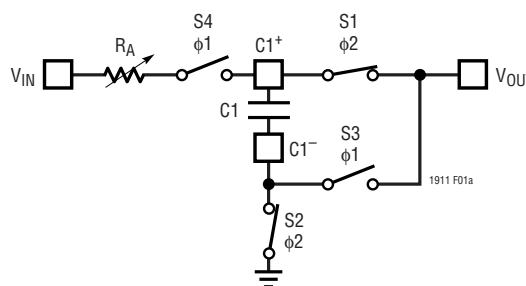

Figure 1a. Step-Down Charge Transfer in 2-to-1 Mode

The 3-to-2 conversion mode also uses a nonoverlapping clock for switch control but requires two flying capacitors and a total of seven switches (see Figure 1b). On phase one of the clock, the two capacitors are connected in parallel to V_{IN} through R_A by switches S5 and S7, and to V_{OUT} through S4 and S6. The amount of charge transferred to $C1||C2$ (and V_{OUT}) is set by the regulator control loop which determines the value of R_A . On phase two, C1 and C2 are connected in series from V_{OUT} to GND through switches S1, S2 and S3. On phase two, half of the charge

APPLICATIONS INFORMATION

transferred to the parallel combination of C1 and C2 is transferred to the V_{OUT} . In this manner, charge is again transferred from the flying capacitors to the output on both phases of the clock. As in 2-to-1 mode, charge current is sourced from GND on phase two of the clock resulting in increased power efficiency. I_{OUT} in 3-to-2 mode equals approximately $(3/2)I_{IN}$.

In 1-to-1 mode (see Figure 1c), switch S1 is always closed connecting the top plate of C1 to V_{OUT} . Switch S2 remains closed for almost the entire clock period, opening only briefly at the end of clock phase one. In this manner, V_{OUT} is connected to V_{IN} through R_A . The value of R_A is set by the regulator control loop which determines the amount of current transferred to V_{OUT} during the on period of S2. The LTC1911 acts much like a linear regulator in this mode. Since all of the V_{OUT} current is sourced from V_{IN} , the efficiency in 1-to-1 mode is approximately equal to that of a linear regulator.

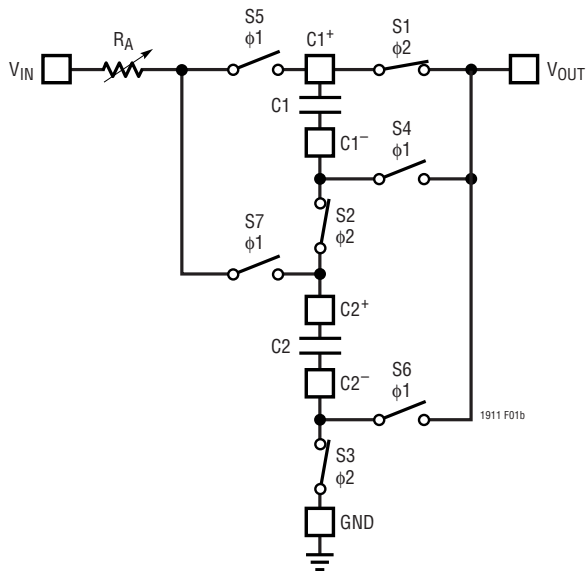

Figure 1b. Step-Down Charge Transfer in 3-to-2 Mode

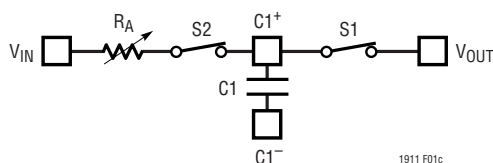

Figure 1c. Step-Down Charge Transfer in 1-to-1 Mode

Mode Selection

The optimal step-down conversion mode is chosen based on V_{IN} and output load conditions. Two internal comparators are used to select the default step-down mode based on the input voltage. Each comparator has an adjustable offset built in that increases (decreases) in proportion to the increasing (decreasing) output load current. In this manner, the mode switch point is optimized to provide peak efficiency over all supply and load conditions. Each comparator also has built-in hysteresis of about 300mV to ensure that the LTC1911 does not oscillate between modes when a transition point is reached.

Soft-Start/Shutdown Operation

The $\overline{SS}/\overline{SHDN}$ pin is used to implement both low current shutdown and soft-start. The soft-start feature limits inrush currents when the regulator is initially powered up or taken out of shutdown. Forcing a voltage lower than 0.6V (typ) on the $\overline{SS}/\overline{SHDN}$ pin will put the LTC1911 into shutdown mode. Shutdown mode disables all control circuitry and forces V_{OUT} into a high impedance state. A 2 μ A pull-up current on the $\overline{SS}/\overline{SHDN}$ pin will force the part into active mode if the pin is left floating or is driven with an open-drain output that is in a high impedance state. If the pin is not driven with an open-drain device, it must be forced to a logic high voltage of 2.2V (min) to ensure proper V_{OUT} regulation. The $\overline{SS}/\overline{SHDN}$ pin should not be driven to a voltage higher than V_{IN} . To implement soft-start, the $\overline{SS}/\overline{SHDN}$ pin must be driven with an open-drain device and a capacitor must be connected from the $\overline{SS}/\overline{SHDN}$ pin to GND. Once the open-drain device is turned off, the 2 μ A pull-up current will begin charging the external soft-start capacitor and force the voltage on the pin to ramp towards V_{IN} . As soon as the shutdown threshold is reached (0.6V typ), the internal reference voltage that controls the V_{OUT} regulation point will follow the ramp voltage on the $\overline{SS}/\overline{SHDN}$ pin (minus a 0.6V offset to account for the shutdown threshold) until the reference reaches its final band gap voltage. This occurs when the voltage on the $\overline{SS}/\overline{SHDN}$ pin reaches approximately 1.9V. Since the ramp rate on the $\overline{SS}/\overline{SHDN}$ pin controls the ramp rate on V_{OUT} , the average inrush current can be controlled through the selection of C_{SS} and C_{OUT} . For example, a

APPLICATIONS INFORMATION

4.7nF capacitor on SS/SHDN results in a 3ms ramp time from 0.6V to 1.9V on the pin. If C_{OUT} is 10 μ F, the 3ms V_{REF} ramp time results in an average C_{OUT} charge current of only 6mA (see Figure 2).

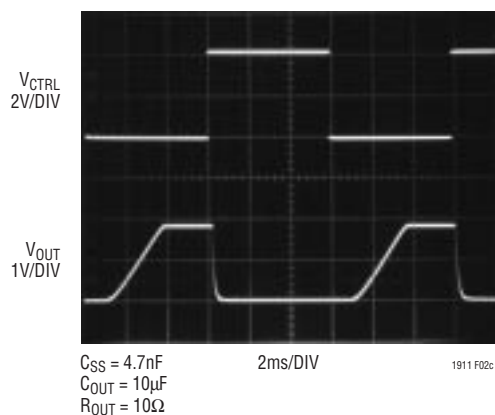
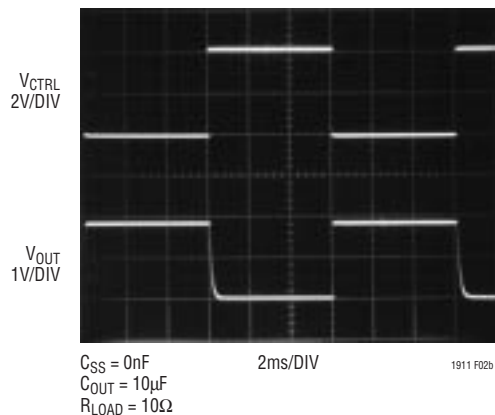
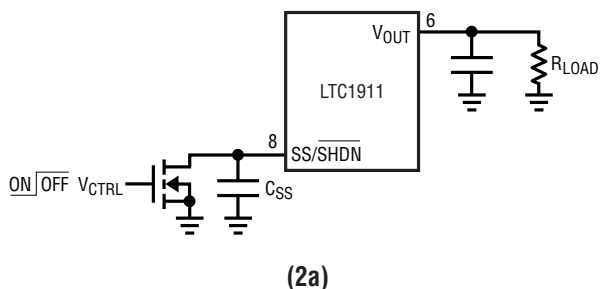

Figure 2. Shutdown/Soft-Start Operation

Low Current Burst Mode Operation

To improve efficiency at low output currents, a Burst Mode function was included in the design of the LTC1911. An output current sense circuit is used to detect when the required output current drops below 30mA typ. When this occurs, the oscillator shuts down and the part goes into a low current operating state. The LTC1911 will remain in the low current operating state until V_{OUT} has dropped enough to require another burst of current. Unlike traditional charge pumps whose burst current is dependant on many factors (i.e., supply, switch strength, capacitor selection, etc.), the LTC1911 burst current is set by the burst threshold. This means that the *output ripple voltage during Burst Mode operation will be fixed and is typically 5mV*.

Short-Circuit/Thermal Protection

The LTC1911 has built-in short-circuit current limiting as well as overtemperature protection. During short-circuit conditions it will automatically limit its output current to approximately 600mA. The LTC1911 will shut down if the junction temperature exceeds approximately 160°C. Under normal operating conditions, the LTC1911 should not go into thermal shutdown but it is included to protect the IC in cases of excessively high ambient temperatures, or in cases of excessive power dissipation inside the IC (i.e., overcurrent or short circuit). The charge transfer will reactivate once the junction temperature drops back to approximately 150°C. The LTC1911 can cycle in and out of thermal shutdown indefinitely without latch-up or damage until the fault condition is removed.

V_{OUT} Ripple and Capacitor Selection

The type and value of capacitors used with the LTC1911 determine several important parameters such as regulator control loop stability, output ripple and charge pump strength.

The value of C_{OUT} directly controls the amount of output ripple for a given load current. Increasing the size of C_{OUT} will reduce the output ripple.

APPLICATIONS INFORMATION

To reduce output noise and ripple, it is suggested that a low ESR ($\leq 0.1\Omega$) ceramic capacitor ($10\mu\text{F}$ or greater) be used for C_{OUT} . Tantalum and Aluminum capacitors are not recommended because of their high ESR (equivalent series resistance).

Both the style and value of C_{OUT} can significantly affect the stability of the LTC1911. As shown in the Block Diagram, the part uses a control loop to adjust the strength of the charge pump to match the current required at the output. The error signal of this loop is stored directly on the output charge storage capacitor. The charge storage capacitor also serves to form the dominant pole for the control loop. To prevent ringing or instability it is important for the output capacitor to maintain at least $4\mu\text{F}$ of capacitance over all conditions (See Ceramic Capacitor Selection Guidelines).

Likewise excessive ESR on the output capacitor will tend to degrade the loop stability of the LTC1911. The closed-loop output resistance of the part is designed to be 0.13Ω . For a 250mA load current change, the output voltage will change by about 33mV . If the output capacitor has 0.13Ω or more of ESR, the closed-loop frequency response will cease to roll-off in a simple 1-pole fashion and poor load transient response or instability could result. Ceramic capacitors typically have exceptional ESR performance, and combined with a tight board layout, should yield excellent stability and load transient performance.

V_{IN} Capacitor Selection

The constant frequency architecture used by the LTC1911 makes input noise filtering much less demanding than with conventional regulated charge pumps. Depending on the mode of operation the input current of the LTC1911 can vary from I_{OUT} to 0mA on a cycle-by-cycle basis. Lower ESR will reduce the voltage steps caused by changing input current, while the absolute capacitor value will determine the level of ripple. For optimal input noise and ripple reduction, it is recommended that a low ESR ceramic capacitor be used for C_{IN} . A tantalum capacitor may be used for C_{IN} but the higher ESR will lead to more input noise. The LTC1911 will operate with capacitors

less than $1\mu\text{F}$ but the increasing input noise will feed through to the output causing degraded performance. For best performance a $1\mu\text{F}$ or greater capacitor is suggested for C_{IN} . Aluminum capacitors are not recommended because of their high ESR.

Flying Capacitor Selection

Warning: A polarized capacitor such as tantalum or aluminum should never be used for the flying capacitors since their voltage can reverse upon start-up of the LTC1911. Ceramic capacitors should always be used for the flying capacitor.

The flying capacitor controls the strength of the charge pump. In order to achieve the rated output current it is necessary for the flying capacitor to have at least $0.4\mu\text{F}$ of capacitance over operating temperature with a 2V bias (See Ceramic Capacitor Selection Guidelines). If only 100mA or less of output current is required the flying capacitor minimum can be reduced to $0.15\mu\text{F}$.

Ceramic Capacitor Selection Guidelines

Capacitors of different materials lose their capacitance with higher temperature and voltage at different rates. For example, a ceramic capacitor made of X7R material will retain most of its capacitance from -40°C to 85°C whereas a Z5U or Y5V style capacitor will lose considerable capacitance over that range (60% to 80% loss typ). Z5U and Y5V capacitors may also have a very strong voltage coefficient causing them to lose an additional 60% or more of their capacitance when the rated voltage is applied. Therefore, when comparing different capacitors it is often more appropriate to compare the amount of achievable capacitance for a given case size rather than discussing the specified capacitance value. For example, over rated voltage and temperature conditions, a $4.7\mu\text{F}$, 10V , Y5V ceramic capacitor in a 0805 case may not provide any more capacitance than a $1\mu\text{F}$, 10V , X7R available in the same 0805 case. In fact, over bias and temperature range, the $1\mu\text{F}$, 10V , X7R will provide more capacitance than the $4.7\mu\text{F}$, 10V , Y5V. The capacitor manufacturer's data sheet should be consulted to determine what value of capacitor

APPLICATIONS INFORMATION

is needed to ensure that minimum capacitance values are met over operating temperature and bias voltage.

Table 1 is a list of ceramic capacitor manufacturers and how to contact them.

Table 1. Ceramic Capacitor Manufacturers

AVX	1-(803)-448-1943	www.avxcorp.com
Kemet	1-(864) 963-6300	www.kemet.com
Murata	1-(800) 831-9172	www.murata.com
Taiyo Yuden	1-(800) 348-2496	www.t-yuden.com
Vishay	1-(800) 487-9437	www.vishay.com

Layout Considerations

Due to the high switching frequency and transient currents produced by the LTC1911, careful board layout is necessary for optimal performance. A true ground plane and short connections to all capacitors will optimize performance, reduce noise and ensure proper regulation over all conditions. Figure 3 shows the recommended layout configuration.

Additional output filtering can be achieved by placing a second output capacitor, connected to the ground plane, about 2cm or more from the LTC1911 output capacitor (C4). The inductance of the trace running to the second output capacitor will significantly attenuate the high speed switching transients of the LTC1911. Even small capacitors as low as 0.1 μ F will provide excellent results.

Thermal Management

The power dissipation in the LTC1911 can cause the junction temperature to rise at rates of up to 160°C/W. If the specified operating conditions are followed, the junction temperature should never exceed the 160°C thermal shutdown temperature. The junction temperature can come very close and possibly exceed the specified 125°C operating junction temperature. To reduce the maximum junction temperature, a good thermal connection to the PC board is recommended. Connecting the GND pin (Pin 4) to a ground plane, and maintaining a solid ground plane under the device on two layers of the PC board, can reduce the thermal resistance of the package and PC board considerably.

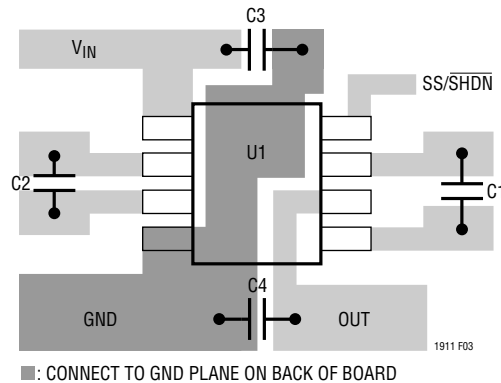
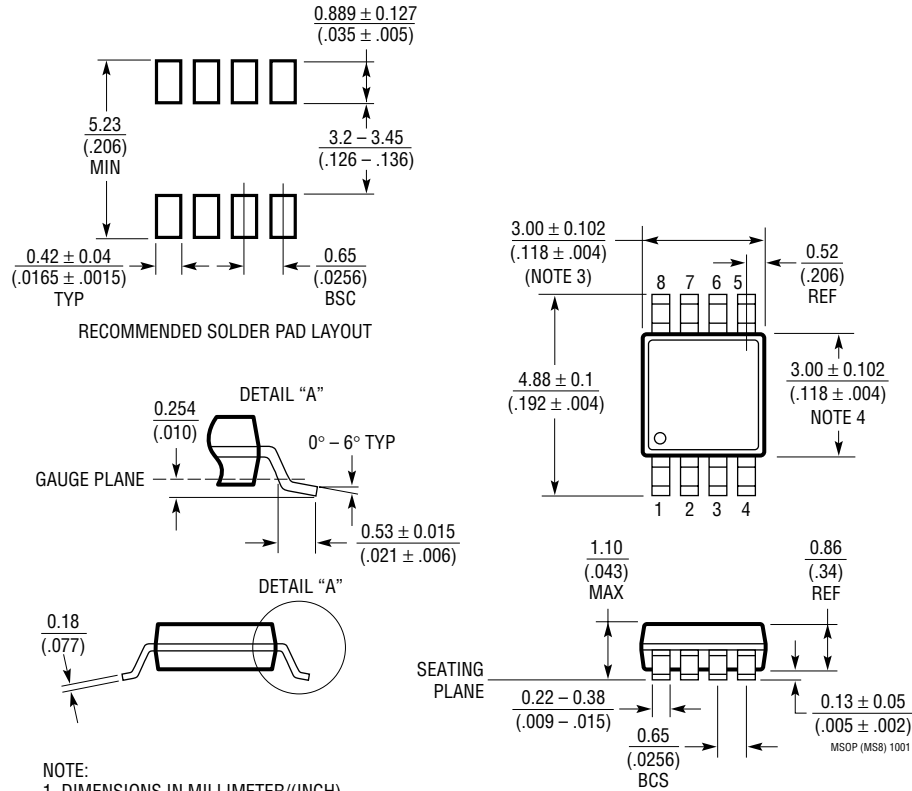

Figure 3. Recommended Component Placement and Grounding

PACKAGE DESCRIPTION

MS8 Package
8-Lead Plastic MSOP
 (Reference LTC DWG # 05-08-1660)



- NOTE:
 1. DIMENSIONS IN MILLIMETER/(INCH)
 2. DRAWING NOT TO SCALE
 3. DIMENSION DOES NOT INCLUDE MOLD FLASH, PROTRUSIONS OR GATE BURRS.
 MOLD FLASH, PROTRUSIONS OR GATE BURRS SHALL NOT EXCEED 0.152mm (.006") PER SIDE
 4. DIMENSION DOES NOT INCLUDE INTERLEAD FLASH OR PROTRUSIONS.
 INTERLEAD FLASH OR PROTRUSIONS SHALL NOT EXCEED 0.152mm (.006") PER SIDE
 5. LEAD COPLANARITY (BOTTOM OF LEADS AFTER FORMING) SHALL BE 0.102mm (.004") MAX

LTC1911-1.5/LTC1911-1.8

TYPICAL APPLICATION

DC/DC Converter with Shutdown and Soft-Start

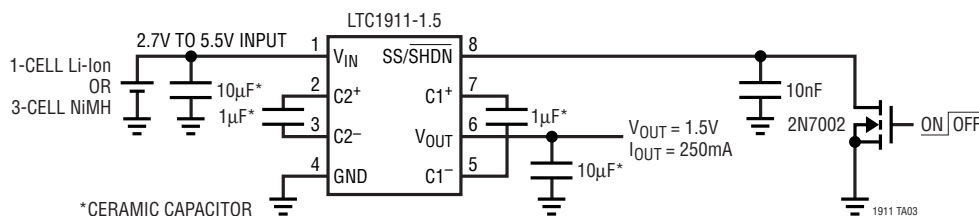

RELATED PARTS

PART NUMBER	DESCRIPTION	COMMENTS
LTC1474/LTC1475	Low Quiescent Current Step-Down DC/DC Converters	I_{OUT} to 250mA, $I_Q = 10$ mA, 8-Lead MSOP
LTC1502-3.3	Single Cell to 3.3V Quadrupler Charge Pump	$V_{IN} = 0.9$ V to 1.8V, $I_{OUT} = 10$ mA, $I_Q = 40$ µA
LTC1503-1.8	1.8V Charge Pump with Shutdown in MS8 Package	100mA Output Current, $I_{CC} = 25$ µA
LTC1514/LTC1515	Micropower, Regulated 5V Step-Up/Step-Down Charge Pump DC/DC Converters	2V to 10V Input Range, Up to 50mA Output Current Short-Circuit and Overtemperature Protected
LTC1555L-1.8	SIM Power Supply and Level Translator	Step-Up/Step-Down Charge Pump Generates 5V, 3V or 1.8V
LTC1627	Monolithic Synchronous Buck Step-Down Switching Regulator	2.65V to 8.5V Input Range, V_{OUT} from 0.8V, I_{OUT} to 500mA, Low Dropout Operation, 100% Duty Cycle
LTC1701	1MHz Step-Down DC/DC Converter in ThinSOT™	$V_{IN} = 2.5$ V to 5.5V; $V_{OUT} = 1.25$ V to 5V; $I_{OUT} = 500$ mA
LTC1754-3.3	3.3V/5V Doubler Charge Pump with Shutdown in ThinSOT	50mA Output Current, $I_{CC} = 13$ µA

ThinSOT is a trademark of Linear Technology Corporation.