

Hyper TOPLED® RG Hyper-Bright LED

LS T776, LA T776, LO T776
LY T776

Besondere Merkmale

- Gehäusefarbe: weiß
- als optischer Indikator einsetzbar
- zur Hinterleuchtung, Lichtleiter- und Linseneinkopplung
- für alle SMT-Bestück- und Löttechniken geeignet
- gegurtet (12-mm-Filmgurt)

Features

- color of package: white
- for use as optical indicator
- for backlighting, optical coupling into light pipes and lenses
- suitable for all SMT assembly and soldering methods
- available taped on reel (12 mm tape)

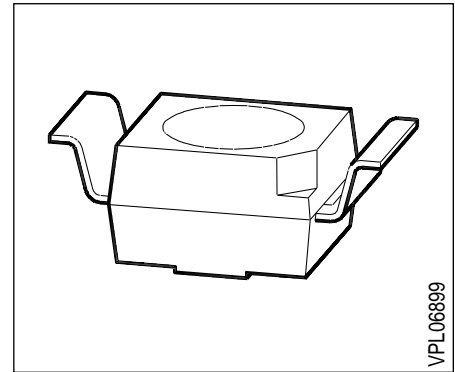

Typ	Emissions- farbe	Farbe der Lichtaustritts- fläche	Lichtstärke	Lichtstrom	Bestellnummer
Type	Color of Emission	Color of the Light Emitting Area	Luminous Intensity $I_F = 20 \text{ mA}$ $I_V \text{ (mcd)}$	Luminous Flux $I_F = 20 \text{ mA}$ $\Phi_V \text{ (mlm)}$	Ordering Code
LS T776-NR	super-red	colorless clear	25 ... 200	-	Q62703-Q3270
LS T776-P			40 ... 80	180 (typ.)	Q62703-Q3271
LS T776-Q			63 ... 125	300 (typ.)	Q62703-Q3272
LS T776-R			100 ... 200	450 (typ.)	Q62703-Q3273
LS T776-PS			40 ... 320	-	Q62703-Q3274
LA T776-PS	amber	colorless clear	40 ... 320	-	Q62703-Q3914
LA T776-Q			63 ... 125	300 (typ.)	Q62703-Q3915
LA T776-R			100 ... 200	450 (typ.)	Q62703-Q3916
LA T776-S			160 ... 320	700 (typ.)	Q62703-Q3917
LA T776-QT			63 ... 500	-	Q62703-Q3918
LO T776-PS	orange	colorless clear	40 ... 320	-	Q62703-Q3275
LO T776-Q			63 ... 125	300 (typ.)	Q62703-Q3276
LO T776-R			100 ... 200	450 (typ.)	Q62703-Q3277
LO T776-S			160 ... 320	700 (typ.)	Q62703-Q3278
LO T776-QT			63 ... 500	-	Q62703-Q3279
LY T776-PS	yellow	colorless clear	40 ... 320	-	Q62703-Q3280
LY T776-Q			63 ... 125	300 (typ.)	Q62703-Q3281
LY T776-R			100 ... 200	450 (typ.)	Q62703-Q3282
LY T776-S			160 ... 320	700 (typ.)	Q62703-Q3283
LY T776-QT			63 ... 500	-	Q62703-Q3284

Streuung der Lichtstärke in einer Verpackungseinheit $I_{V \max} / I_{V \min} \leq 2.0$.

Luminous intensity ratio in one packaging unit $I_{V \max} / I_{V \min} \leq 2.0$.

Grenzwerte Maximum Ratings

Bezeichnung Parameter	Symbol Symbol	Werte Values		Einheit Unit
		LS, LO, LA	LY	
Betriebstemperatur Operating temperature range	T_{op}	- 55 ... + 100		°C
Lagertemperatur Storage temperature range	T_{stg}	- 55 ... + 100		°C
Sperrschichttemperatur Junction temperature	T_j	+ 100		°C
Durchlaßstrom Forward current	I_F	30	20	mA
Stoßstrom Surge current $t \leq 10 \mu s, D = 0.005$	I_{FM}	1	0.2	A
Sperrspannung ¹⁾ Reverse voltage ¹⁾	V_R	3		V
Verlustleistung Power dissipation	P_{tot}	80	55	mW
Wärmewiderstand Thermal resistance Sperrschicht / Umgebung Junction / air Montage auf PC-board*) (Padgröße $\geq 16 \text{ mm}^2$) mounted on PC board*) (pad size $\geq 16 \text{ mm}^2$)	$R_{th JA}$	500		K/W

1) Belastung in Sperrichtung sollte vermieden werden.

1) Reverse biasing should be avoided.

*) PC-board: FR4

Kennwerte ($T_A = 25\text{ °C}$)

Characteristics

Bezeichnung Parameter	Symbol Symbol	Werte Values				Einheit Unit
		LS	LA	LO	LY	
Wellenlänge des emittierten Lichtes Wavelength at peak emission $I_F = 20\text{ mA}$	(typ.) λ_{peak} (typ.)	645	622	610	591	nm
Dominantwellenlänge Dominant wavelength $I_F = 20\text{ mA}$	(typ.) λ_{dom} (typ.)	632	615	605	587	nm
Spektrale Bandbreite bei 50% $I_{\text{rel max}}$ Spectral bandwidth at 50% $I_{\text{rel max}}$ $I_F = 20\text{ mA}$	(typ.) $\Delta\lambda$ (typ.)	16	16	16	15	nm
Abstrahlwinkel bei 50% I_v (Vollwinkel) Viewing angle at 50% I_v	2ϕ	120	120	120	120	Grad deg.
Durchlaßspannung Forward voltage $I_F = 20\text{ mA}$	(typ.) V_F (max.) V_F	2.0 2.6	2.0 2.6	2.0 2.6	2.0 2.6	V V
Sperrstrom Reverse current $V_R = 3\text{ V}$	(typ.) I_R (max.) I_R	0.01 10	0.01 10	0.01 10	0.01 10	μA μA
Temperaturkoeffizient von λ_{dom} ($I_F = 20\text{ mA}$) Temperature coefficient of λ_{dom} ($I_F = 20\text{ mA}$)	TC_λ	0.014	0.062	0.067	0.096	nm/K
Temperaturkoeffizient von λ_{peak} , $I_F = 20\text{ mA}$ Temperature coefficient of λ_{peak} , $I_F = 20\text{ mA}$	(typ.) TC_λ (typ.)	0.14	0.13	0.13	0.13	nm/K
Temperaturkoeffizient von V_F , $I_F = 20\text{ mA}$ (typ.) Temperature coefficient of V_F , $I_F = 20\text{ mA}$ (typ.)	TC_V	-1.95	-1.78	-1.67	-2.51	mV/K

Relative spektrale Emission $I_{rel} = f(\lambda)$, $T_A = 25\text{ °C}$, $I_F = 10\text{ mA}$

Relative spectral emission

$V(\lambda)$ = spektrale Augenempfindlichkeit

Standard eye response curve

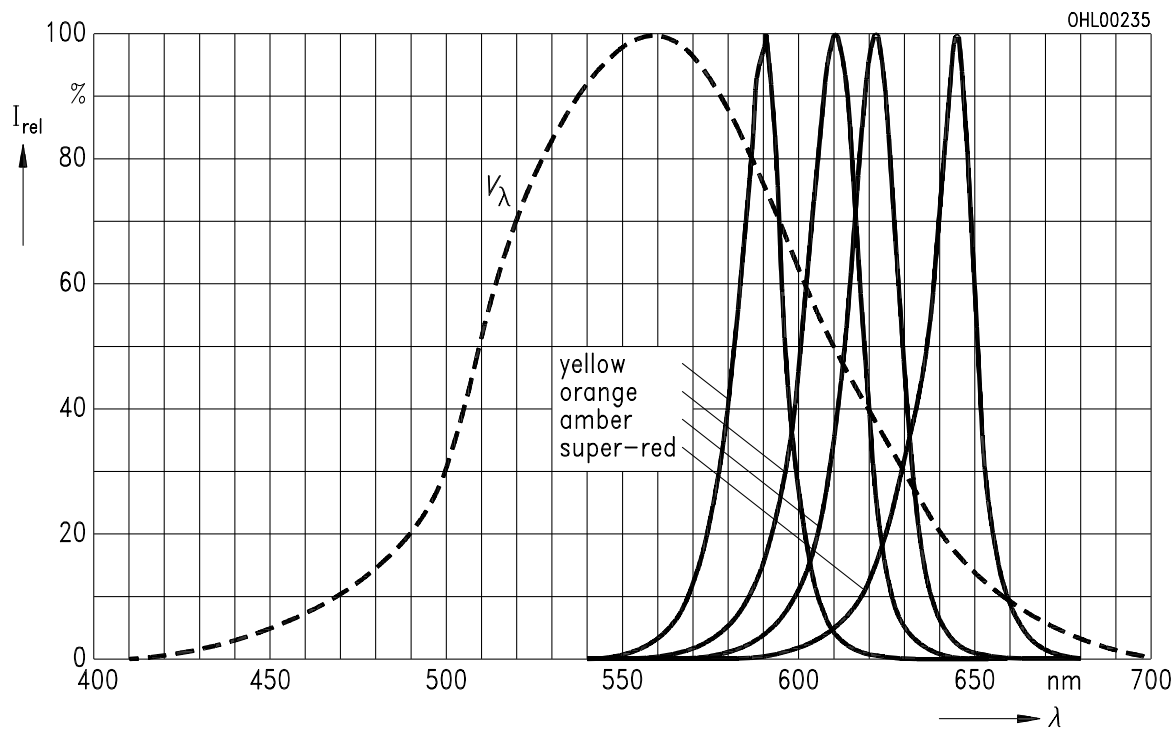

Abstrahlcharakteristik $I_{rel} = f(\varphi)$

Radiation characteristic

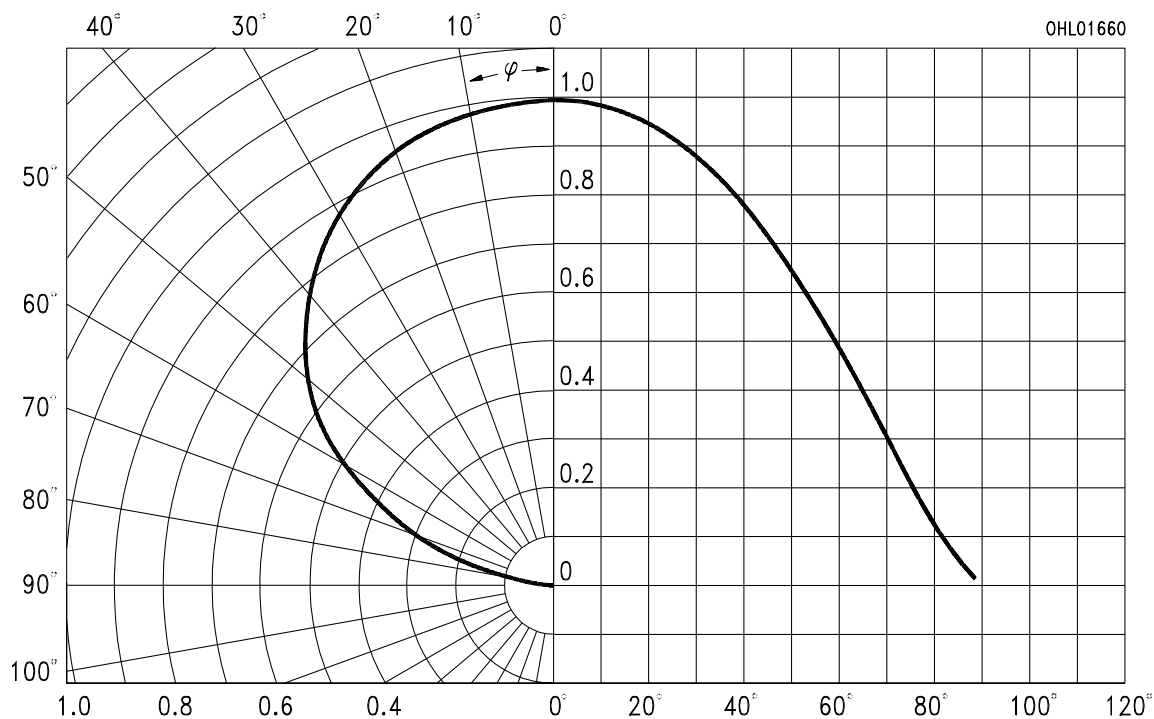

Durchlaßstrom $I_F = f(V_F)$

Forward current

$T_A = 25^\circ\text{C}$

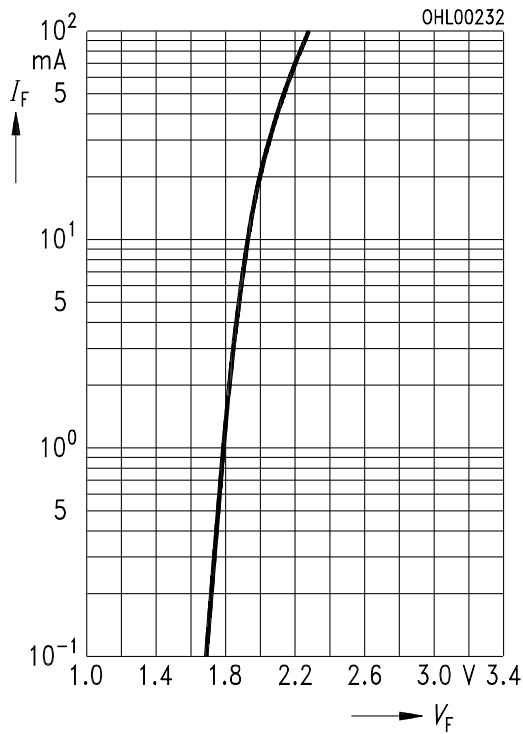

Maximal zulässiger Durchlaßstrom

Max. permissible forward current

$I_F = f(T_A)$

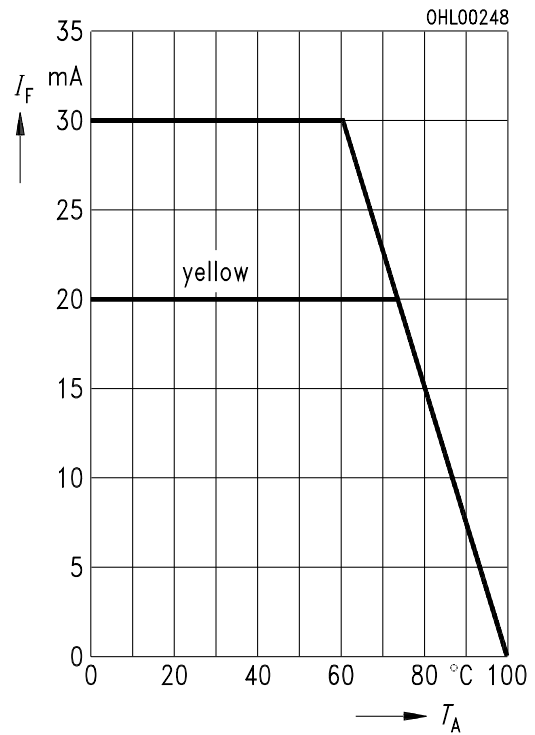

Relative Lichtstärke $I_V / I_{V(20\text{mA})} = f(I_F)$

Relative luminous intensity

$T_A = 25^\circ\text{C}$

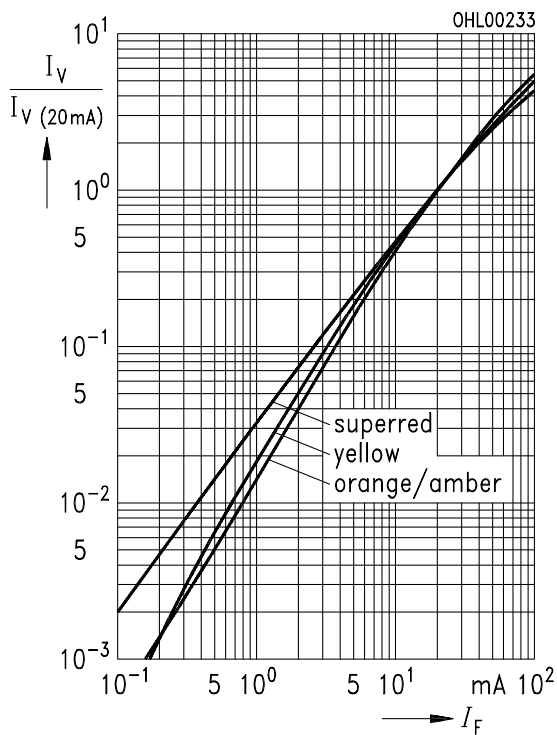

Relative Lichtstärke $I_V / I_{V(25^\circ\text{C})} = f(T_A)$

Relative luminous intensity

$I_F = 20\text{ mA}$

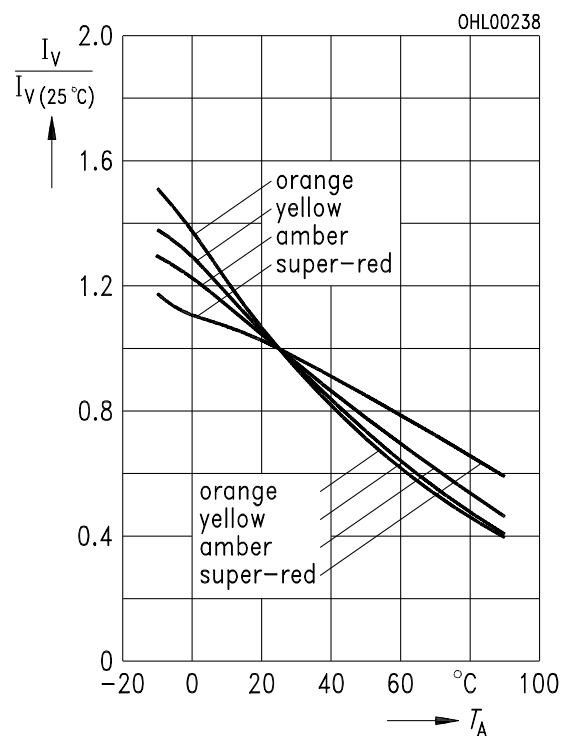

Zulässige Impulsbelastbarkeit $I_F = f(t_p)$
Permissible pulse handling capability
LS, LA, LO

Duty cycle $D =$ parameter, $T_A = 25\text{ °C}$

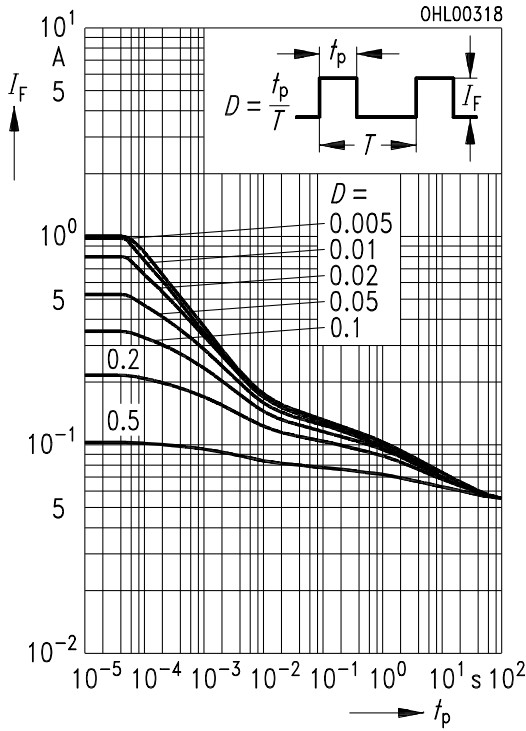

Zulässige Impulsbelastbarkeit $I_F = f(t_p)$
Permissible pulse handling capability
LY

Duty cycle $D =$ parameter, $T_A = 25\text{ °C}$

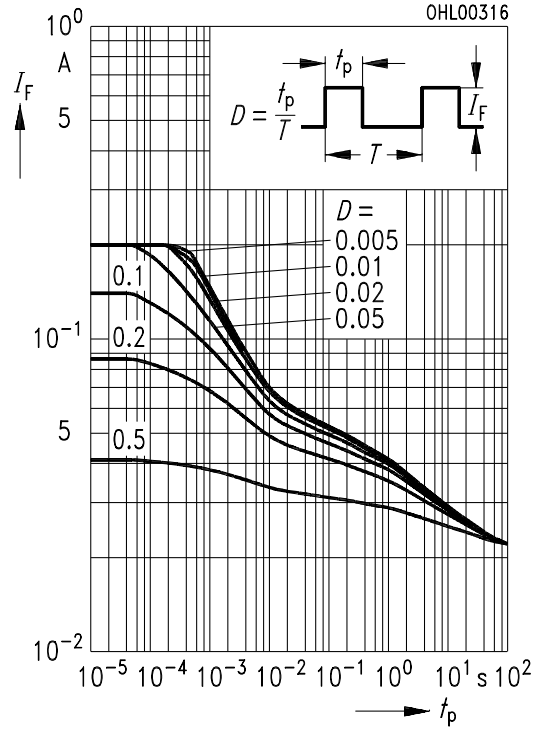

Maßzeichnung
Package Outlines

(Maße in mm, wenn nicht anders angegeben)
 (Dimensions in mm, unless otherwise specified)

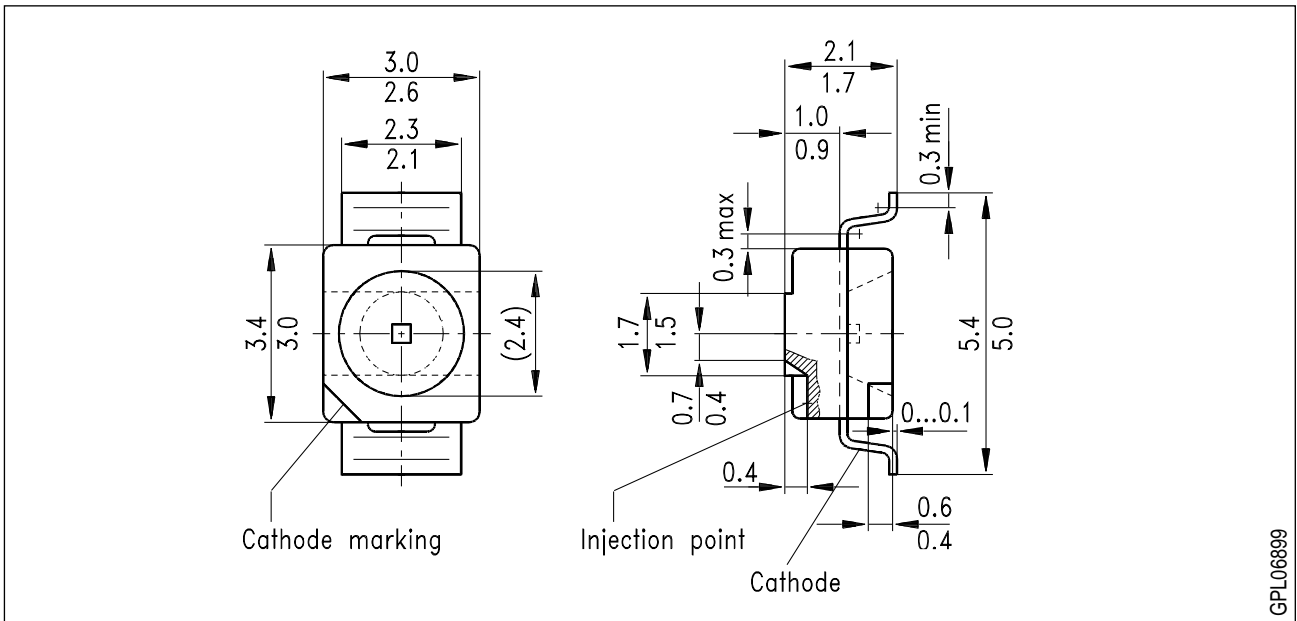

GPL06899

Kathodenkennung: abgeschrägte Ecke
Cathode mark: bevelled edge