



## SINGLE CHIP VOLTAGE SYNTHESIS TUNING SYSTEMS WITH 1 ANALOG CONTROL

- M490B 16 STATION MEMORY - SINGLE DOT LED DISPLAY
- M491B 16 STATION MEMORY - 7 SEGMENT LED DISPLAY
- VOLTAGE SYNTHESIZER : 13 BITS
- 4 BAND PRESET CAPABILITY
- NON VOLATILE MEMORY : 304 BITS
  - 16 WORDS OF 19 BITS FOR TUNING VOLTAGE (13 bits) - BAND (2 bits) - FINE DETUNING (4 bits)
  - $10^4$  MODIFY CYCLES PER WORD
  - MIN 10 YEARS DATA RETENTION
- PCM REMOTE CONTROL RECEIVER : DECODES SIGNAL TRANSMITTED BY M708
- VOLUME D/A : 6 BIT RESOLUTION/8 KHz
- MEMORY SKIP FUNCTION
- AUTOMATIC SEARCH WITH DIGITAL AFT CONTROL
- FINE DETUNING D/A ACTING ON AFT DISCRIMINATOR (16 steps) WITH SEPARATE STORAGE FOR EACH MEMORY POSITION. ALTERNATIVELY IT CAN BE USED TO CONTROL BRIGHTNESS OR COLOUR SATURATION
- MANUAL SEARCH WITH DIGITAL AFT CONTROL
- MANUAL SEARCH WITH LINEAR AFT
- SWEEP SEARCH DISPLAY OUTPUT
- SUPPLY VOLTAGES :  $V_{DD} = + 5 V$   
 $V_{PP} = + 25 V$  FOR THE MEMORY
- CLOCK OSCILLATOR : 445 TO 510 KHz
- INTEGRATED DIGITAL POWER ON RESET (no external initialization circuitry required)

### DESCRIPTION

The M490B and M491B are monolithic N-MOS LSI circuits including a Floating-gate Non-Volatile Memory for storage of up to 16 stations. Tuning of the station is performed with a 8192 step D/A converter, using the principle of voltage synthesis.

The M490B is designed to drive single dot LED displays (one LED is necessary for each used memory position). Direct and Up/Down memory selection is possible on the set or from remote control. Memory positions 11 to 16 can be skipped in case of Up/Down commands.

The M491B is designed for 7 segment LED displays. Direct memory selection is possible only from remote control while Up/Down memory scanning is possible on the set and also from remote control. An option input for 8 or 16 stations is available.

The circuits also include a PCM remote control receiver operating in conjunction with the transmitter M708. The highly reliable transmission code ensures error free signal detection even in presence of high noise conditions.

Search of the station is possible in automatic or manual modes. The circuits can operate with a Digital or Linear AFT control.

The Digital AFT mode is necessary for automatic search and requires an external circuit (TDA4433 or equivalent, e.g. dual comparator plus TV station detector) to convert the AFC-S-curve into a Up/Down command.

Fine tuning (detuning) is also possible with different modes of operation.

The circuits are assembled in 40 pin dual in-line plastic package.

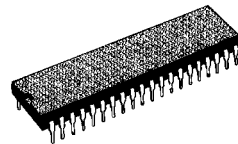

DIP40

ORDER CODE : M490B B1  
M491B B1

**ABSOLUTE MAXIMUM RATINGS**

Symbol	Parameter	Value	Unit
V <sub>DD</sub>	Supply Voltage	- 0.3 to 7	V
V <sub>PP</sub>	Memory Supply Voltage	- 0.3 to 28	V
V <sub>I</sub>	Input Voltage	- 0.3 to 15	V
V <sub>O (off)</sub>	Off State Input Voltage (except pin 3) Pin 3	15 28	V V
I <sub>OL</sub>	Output Low Current Led Driver Outputs   M490B Pins 6 - 14   M491B Pins 4 - 5 All Other Outputs	25 20 20 7.5 5	mA mA mA mA mA
t <sub>pd</sub>	Max. Delay between Memory Timing and Memory Supply Pulses	5	µs
P <sub>tot</sub>	Total Package Power Dissipation	1	W
T <sub>stg</sub>	Storage Temperature	- 25 to 125	°C
T <sub>op</sub>	Operating Temperature	0 to 70	°C

Stresses above those listed under "Absolute Maximum Ratings" may cause permanent damage to the device. This is a stress rating only and functional operation of the device at these or any other conditions above those indicated in the operational sections of this specification is not implied. Exposure to absolute maximum rating conditions for extended periods may affect device reliability.

**PIN CONNECTIONS**

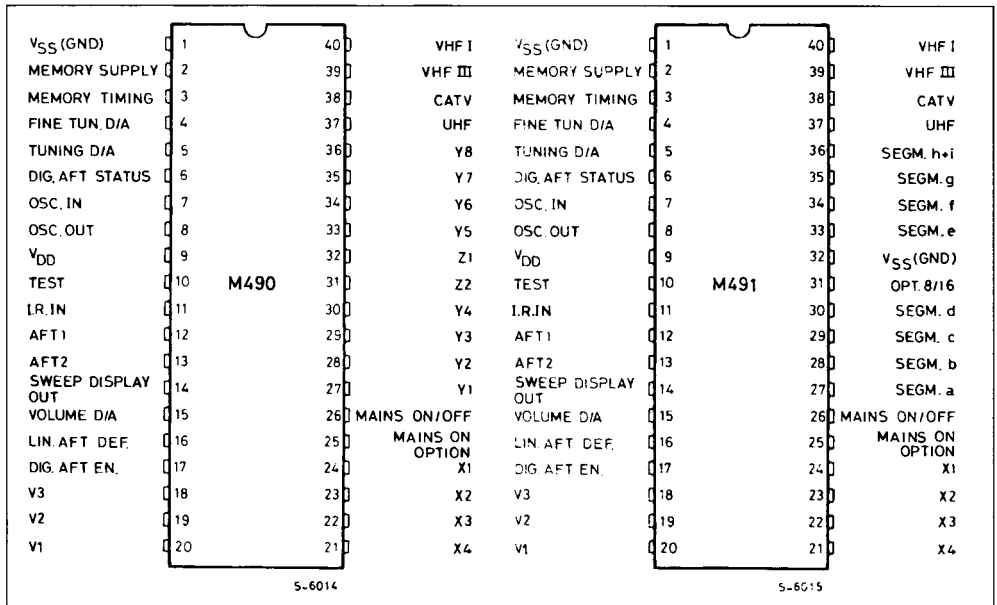

FUNCTIONAL DIAGRAM

Figure 1.

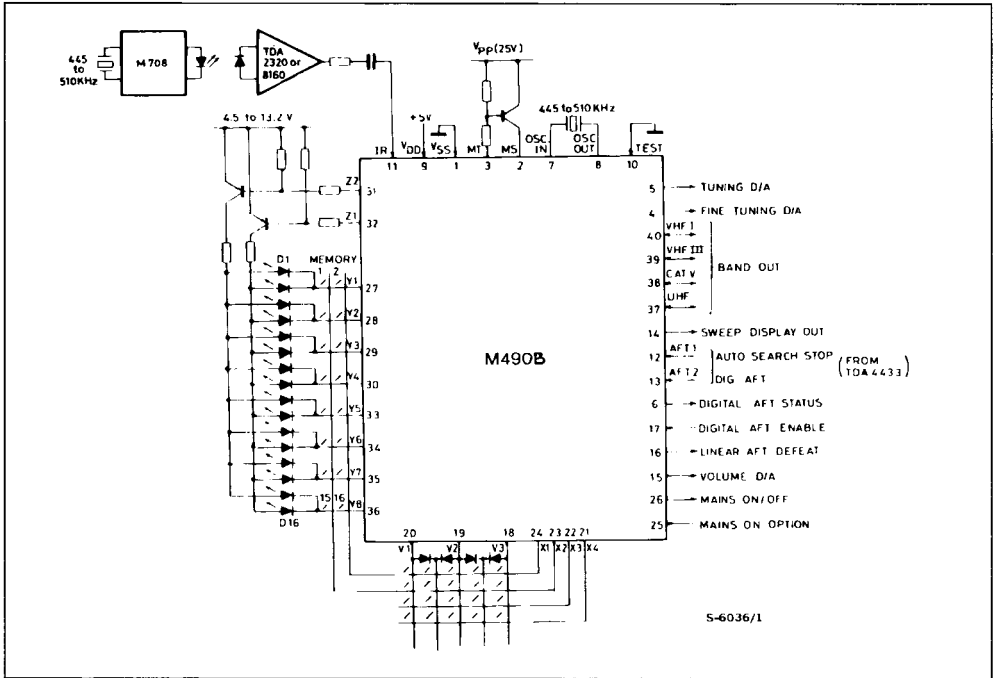
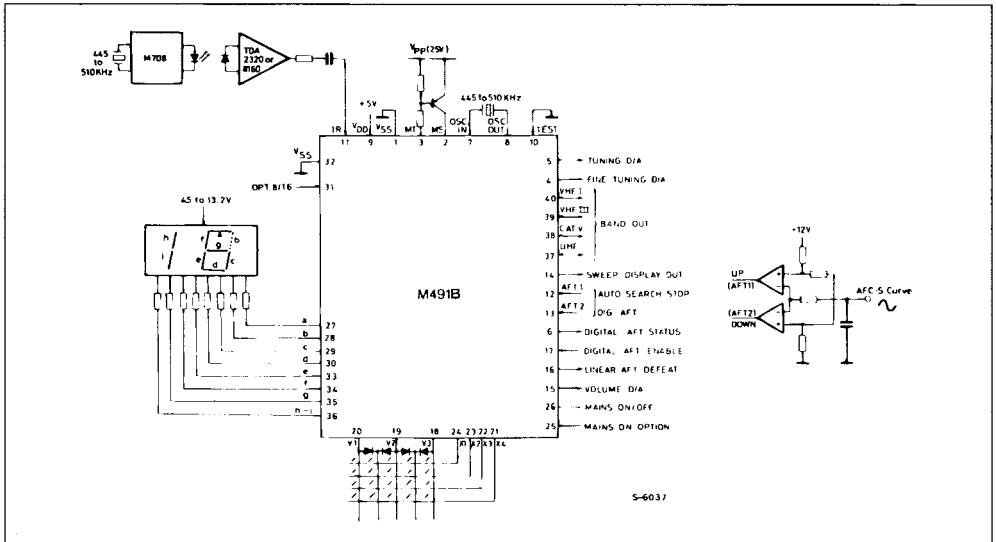

Figure 2.



**M490B STATIC ELECTRICAL CHARACTERISTICS** ( $t_{amb} = 0$  to  $70$  °C,  $V_{DD} = 5$  V unless otherwise specified)

Pins	Symbol	Parameter	Test Conditions	Value			Unit	
				Min.	Typ.	Max.		
2-Memory Supply	$I_{PP}$	Memory Supply Current	$V_{PP} = 26$ V					
			Write	Peak Average			42 12	mA mA
			Erase	Peak Average			9 5	mA mA
			Read	Peak Average			8 2.5	mA mA
	R	Pull Down Resistor				25	K $\Omega$	
3-Write Timing Out	$V_{OL}$	Output Low Voltage	$V_{DD} = 4.75$ V $I_{OL} = 2.5$ mA			8	V	
	$I_{O(off)}$	Output Leakage Current	$V_{DD} = 4.75$ V $V_{OUT} = 26$ V			100	$\mu$ A	
4-Fine Tuning D/A 5-Tuning D/A	$I_{O(off)}$		$V_{DD} = 5.25$ V $V_{O(off)} = 13.2$ V			50	$\mu$ A	
	$V_{OL}$		$V_{DD} = 4.75$ V $I_{OL} = 5$ mA			1	V	
6-Digital AFT Out	$V_{OL}$		$V_{DD} = 4.75$ V $I_{OL} = 20$ mA			1.5	V	
	$I_{O(off)}$		$V_{DD} = 5.25$ V $V_{O(off)} = 13.2$ V			100	$\mu$ A	
9-Power Supply	$I_{DD}$	Supply Current	$V_{DD} = 5.25$ V			100	mA	
11-I.R. Input	$V_{iPP}$	Peak to Peak Voltage			0.5	13.2	V	
12-AFT1 13-AFT2	$V_{iL}$	Input low Voltage	$V_{DD} = 5.25$ V			1.5	V	
	$V_{iH}$	Input High Voltage	$V_{DD} = 5.25$ V		3.5		V	
	$I_{iL}$	Input Low Current	$V_{DD} = 5.25$ V $V_{iL} = 1.5$ V			-0.4	mA	
	R	Pull-up Resistor				30	K $\Omega$	
14-Display Out	$V_{OL}$		$V_{DD} = 4.75$ V $I_{OL} = 20$ mA			1.5	V	
	$I_{O(off)}$		$V_{DD} = 5.25$ V $V_{O(off)} = 13.2$ V			100	$\mu$ A	
15-Volume D/A	$V_{OL}$		$V_{DD} = 4.75$ V $I_{OL} = 4$ mA			1	V	
	$I_{O(off)}$		$V_{DD} = 5.25$ V $V_{O(off)} = 13.2$ V			50	$\mu$ A	
16-Linear AFT Out	$V_{OL}$		$V_{DD} = 4.75$ V $I_{OL} = 1$ mA			0.4	V	
	$I_{O(off)}$		$V_{DD} = 5.25$ V $V_{O(off)} = 13.2$ V			50	$\mu$ A	
17-Digital AFT Enable	$V_{iL}$					0.8	V	
	$V_{iH}$				2.0		V	
	$I_{iL}$		$V_{DD} = 5.25$ V $V_{iL} = 0.8$ V			-0.4	mA	
	R	Pull-up Resistor				30	K $\Omega$	
V3 V2 } Keyboard V1 } In	$V_{iL}$					1.5	V	
	$V_{iH}$				3.5		V	
	$I_{iL}$		$V_{DD} = 5.25$ V $V_{iL} = 0.8$ V			-0.4	mA	
	R	Pull-up Resistor				30	K $\Omega$	

## M490B STATIC ELECTRICAL CHARACTERISTICS (continued)

Pin	Symbol	Parameter	Test Conditions	Values			Unit
				Min.	Typ.	Max.	
21-22-23-24 X4 X3 } Keyboard X2 } Out X1 }	$V_{OL}$		$V_{DD} = 4.75\text{ V}$ $I_{OL} = 1\text{ mA}$			0.4	V
	$I_{O\text{ (off)}}$		$V_{O\text{ (off)}} = 5.5\text{ V}$			25	$\mu\text{A}$
25-Mains On Enable	$V_{IL}$					0.8	V
	$V_{IH}$			2.4			V
	$I_{IL}$		$V_{DD} = 5.25\text{ V}$			-0.4	mA
	R	Pull-up Resistor	$V_{IL} = 0.8\text{ V}$		30		K $\Omega$
26-Mains On/Off	$V_{OL}$		$V_{DD} = 4.75\text{ V}$ $I_{OL} = 100\ \mu\text{A}$			0.4	V
	$I_{O}$		$V_{DD} = 4.75\text{ V}$ $V_{O} = 0.7\text{ V}$	-1.6			mA
27-28-29-30 33-34-35-36 Keyboard In and Display Out	$V_{IL}$					1.5	V
	$V_{IH}$			3.5			V
	$I_{IL}$		$V_{DD} = 5.25\text{ V}$ $V_{IL} = 0.8\text{ V}$			-0.5	mA
	R	Pull-up Resistor			30		K $\Omega$
	$V_{OL}$		$V_{DD} = 4.75\text{ V}$ $I_L = 20\text{ mA}$			1.5	V
31-Z2 } MPX 32-Z1 } for Display Out	$V_{OL}$		$V_{DD} = 4.75\text{ V}$ $I_{OL} = 1\text{ mA}$			0.4	V
	$I_{O\text{ (off)}}$		$V_{DD} = 5.25\text{ V}$ $V_{O\text{ (off)}} = 13.2\text{ V}$			50	$\mu\text{A}$
37-UHF } B 38-CATV } A 39-VHFIII } N 40-VHFI } D	$V_{OL}$		$V_{DD} = 4.75\text{ V}$ $I_{OL} = 1\text{ mA}$			3	V
	$V_{OH}$		$V_{DD} = 4.75\text{ V}$ $I_{OH} = -150\ \mu\text{A}$	2.4			V
	$V_{IL}$					0.3	V
	$V_{IH}$				3		V
	$I_{O\text{ (off)}}$		$V_{DD} = 5.25\text{ V}$ $V_{O\text{ (off)}} = 13.2\text{ V}$			50	$\mu\text{A}$

## M491B : ALL PINS AS FOR M490B WITH EXCEPTION OF :

27-28-29-30 33-34-35 Display Out	$V_{OL}$		$V_{DD} = 4.75\text{ V}$ $I_{OL} = 20\text{ mA}$			1.5	V
36-Display Out	$V_{OL}$		$V_{DD} = 4.75\text{ V}$ $I_{OL} = 30\text{ mA}$			1.5	V
31-Memory 8/16	$V_{IH}$			2.0			V
	$V_{IL}$					0.8	V

DESCRIPTION (timings are with  $f_{\text{clock}} = 500\text{ KHz}$ )PIN 1.  $V_{SS}$ 

The substrate of the IC is connected to this pin. It is reference pin for all parameters of the IC.

## PIN 2. MEMORY SUPPLY VOLTAGE

A supply voltage of  $25 \pm 1\text{ V}$  has to be applied to this pin during the modify and read cycles.

## MODIFY CYCLE

A modify cycle consists of three steps :

1. All "1"s are written in the bits of the selected word.
2. All bits of the selected word are erased (all "0"s)
3. The new content is written.

In this way a constant aging of all the bits of the word is obtained.

During both write and erase cycles the memory situation is checked continuously ; therefore after each write or erase pulse a read operation is carried out. The write or the erase operations are stopped as soon as the result of the read operation is valid.

**WRITE CYCLE.** The peak of the current flowing through pin 2 during a write operation is shown in fig. 3, while fig. 4 shows the envelope of the same current.

The typical write time is 3-4 ms for the first cycles and increases to about 30 ms after 1000 cycles.

Figure 3.

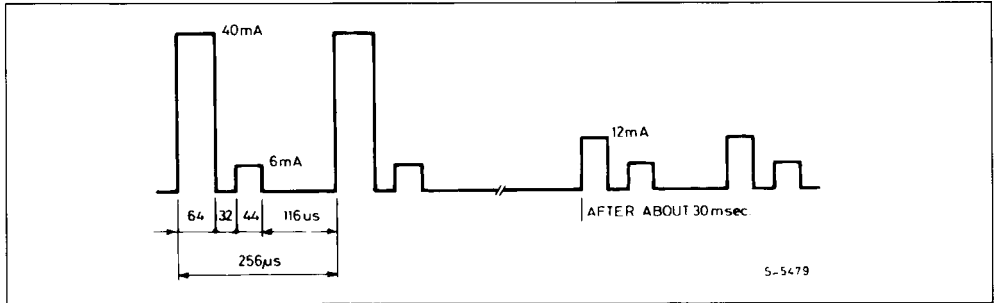
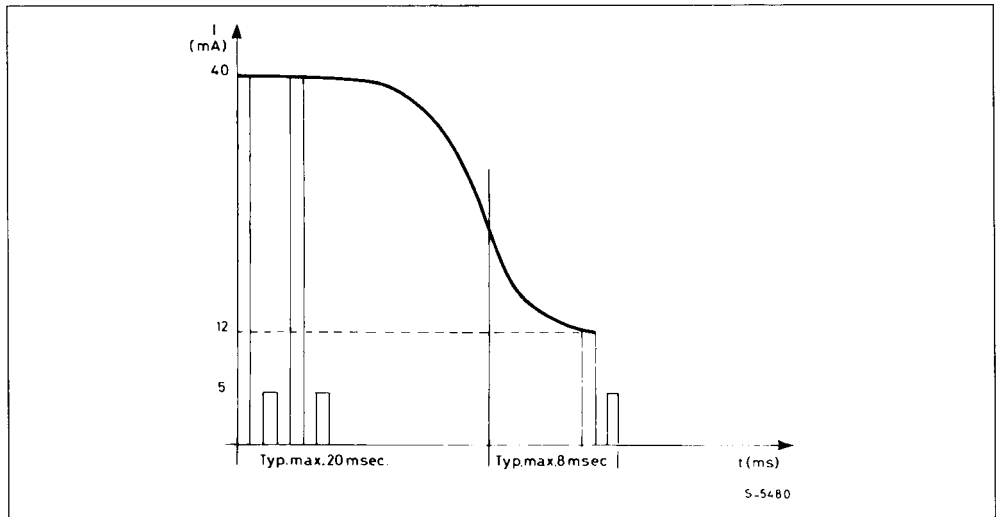

Figure 4.



**ERASE CYCLE.** Fig. 5 shows the timing and the waveform of the current flowing through pin 2 during the erase operation. The peak current is 7 mA (max) during the erase cycle and 6 mA (max) dur-

ing the read cycle. The typical erase time is 10 ms for a new device and it increases with the number of modify operations up to 200 ms after 1000 cycles.

Figure 5.

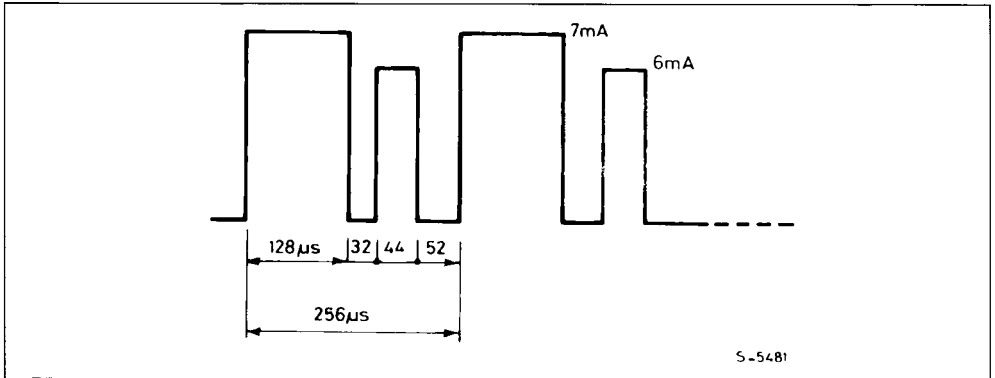

In order to protect the memory in case of failure of some bits the modify operation is stopped after 1 sec.

#### READ CYCLE

Fig. 6 shows the waveform of the current during a read operation.

Figure 6.

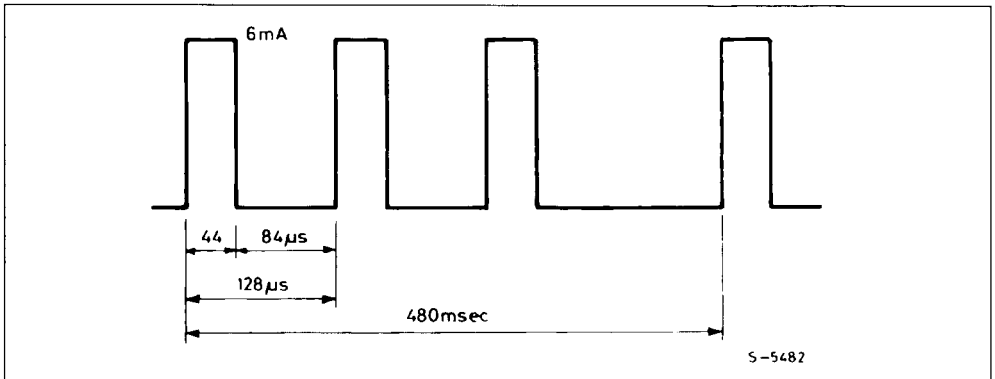

#### PIN 3. MEMORY TIMING OUTPUT

This output gives the timing for the pulses to be applied at pin 2 during the modify and read cycles. The output consists of an open drain transistor.

#### PIN 4. FINE TUNING D/A

A D/A converter with 16 step resolution and a fre-

quency of 15 KHz can be used to generate a voltage which, if fed to a varicap diode in parallel to the AFC discriminator, will detune the receiver by a small  $\Delta f$  while maintaining the action of the Digital AFT. This output can be used in conjunction with both Linear and Digital AFT modes of operations.

Figure 7.

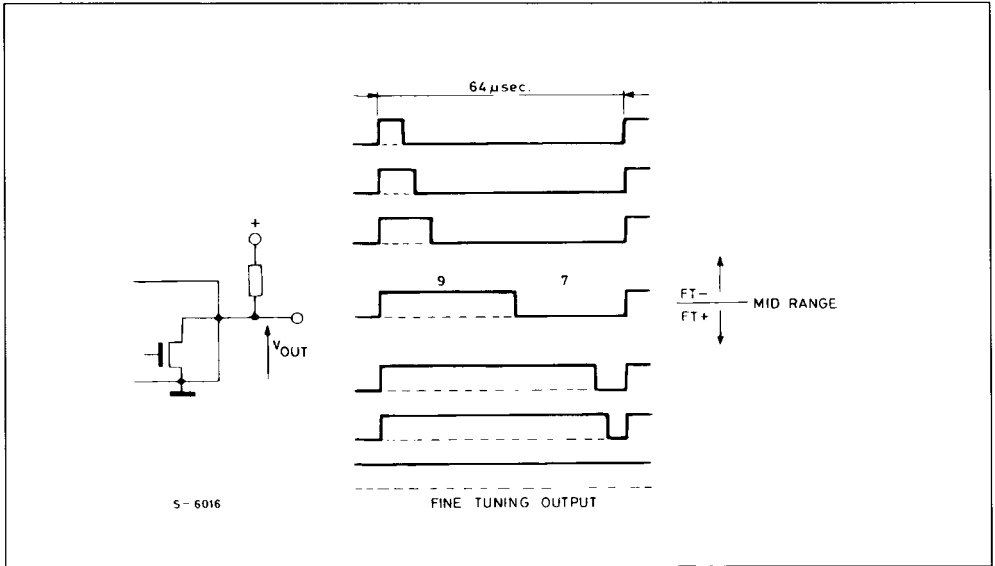

The Fine tuning function operates as follows :

- At the start of any automatic or manual search, the output is set at the mid range.
- When the search has been completed it is possible to operate on FT  $\pm$  commands. The store command memorizes this information together with the 13 tuning voltage and 2 bit and information.
- Modification time of FT D/A is of 1 step every 200 ms if issued locally or every 2 received signals from Remote control transmitter.

Pulse modulation is implemented by combination of a rate multiplier and pulse width principle.

With a tuning voltage increasing from zero, the number of pulses increases continuously up to  $2^8 = 256$  ; starting from this point the number of pulses remains the same but the pulses get larger until they reach the maximum content of the internal counter. The output consists of an open drain transistor which offers a low impedance to ground when in the ON state.

PIN 5. TUNING D/A

A  $2^{13} = 8192$  step pulse modulated signal for the tuning voltage is available on this pin.



Figure 8.

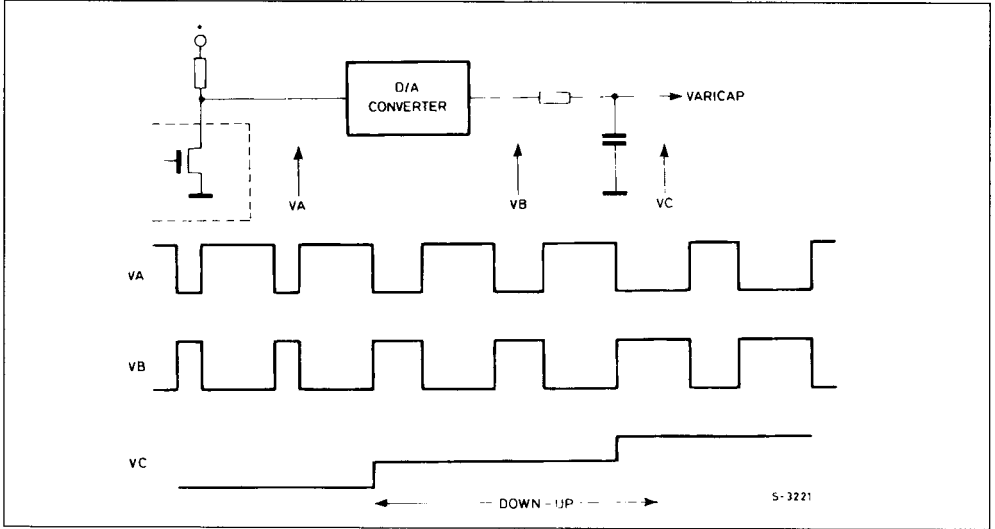

#### PIN 6. DIGITAL AFT STATUS OUTPUT

This output shows the status of the digital AFT. It is low when the digital AFT is enabled and it can directly drive a LED.

The output consists of an open drain transistor.

Figure 9.

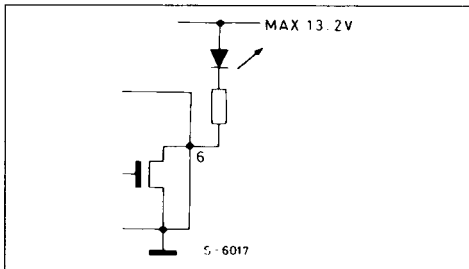

#### PINS 7-8. OSCILLATOR INPUT/OUTPUT

The frequency of the clock oscillator should be between 445 and 510 kHz using a cheap ceramic resonator. In these conditions the value of the reference frequency of the transmitter can be in the same range. In other words the transmitter and the receiver can operate with different reference frequencies.

Figure 10.

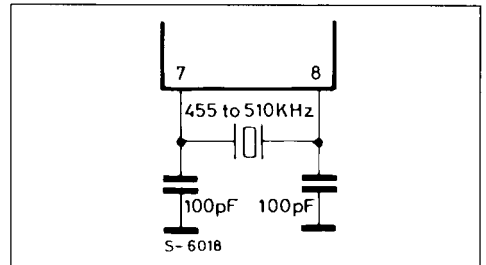

#### PIN 9. V<sub>DD</sub>

The supply voltage has to be comprised in the range 4.75 to 5.25 V. When it is applied an internal power on reset of 0.5 s is generated.

The memory position 1 is automatically read if the mains on option input (pin 25) is grounded.

#### PIN 10. TEST

This pin is used for testing and has to be connected to V<sub>SS</sub>.

#### PIN 11. I.R. SIGNAL INPUT

The integrated receiver decodes signals transmitted by M708, address 9.

The minimum signal to be applied is 0.5 V peak to peak. (AC coupled).

The receiver input section performs the following tests on the incoming signal to achieve the necessary noise immunity :

- measurement of the pulse distance (time base synchronization)
- check of the position of the received bits opening window at the time bases
- check of the parity bit
- check of the absence of pulses between the parity bit and the stop-pulse

- check of noise level ; the receiver checks parasitic transient inside and outside the time windows.

If the above test conditions are not fulfilled, the received word is rejected and not decoded. If the received signal is acknowledged as a valid word it is stored an decoded.

The end of transmission will be acknowledged by receiving the end of transmission code or by means of an internal timer if the transmission remains interrupted for more than about 550 ms.

**Figure 11.**

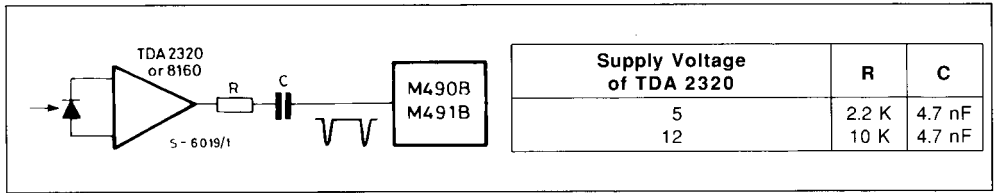

**MA490B/M491B REMOTE CONTROL RECEIVER TRUTH TABLE. TRANSMITTER M708 ; ADDRESS CODE N°8**

Command N°	I.R. Code						Function
	C1	C2	C3	C4	C5	C6	
0	0	0	0	0	0	0	End to Transmission
1	1	0	0	0	0	0	Power On/Off
2	1	1	0	0	0	0	Mute On/Off
3	0	0	1	0	0	0	Memory 1
4	1	0	1	0	0	0	Memory 2
5	0	1	1	0	0	0	Memory 3
6	1	1	1	0	0	0	Memory 4
7	1	0	0	0	1	0	Fine Detuning Up
8	1	1	0	0	1	0	Fine Detuning Down
9	0	0	1	0	1	0	Memory 5
10	1	0	1	0	1	0	Memory 6
11	0	1	1	0	1	0	Memory 7
12	1	1	1	0	1	0	Memory 8
13	1	0	0	0	0	1	Memory Up
14	1	1	0	0	0	1	Memory Down
15	0	0	1	0	0	1	Memory 9
16	1	0	1	0	0	1	Memory 10
17	0	1	1	0	0	1	Memory 11
18	1	1	1	0	0	1	Memory 12

**MA490B/M491B REMOTE CONTROL RECEIVER TRUTH TABLE.  
TRANSMITTER M708 ; ADDRESS CODE N°8**

Command N°	I.R. Code						Function
	C1	C2	C3	C4	C5	C6	
19	1	0	0	0	1	1	Man. Search Up
20	1	1	0	0	1	1	Man. Search Down
21	0	0	1	0	1	1	Memory 13
22	1	0	1	0	1	1	Memory 14
23	0	1	1	0	1	1	Memory 15
24	1	1	1	0	1	1	Memory 16
25	1	0	0	1	1	1	Volume Up } Mute
26	1	1	0	1	1	1	Volume Down } Off
27	0	0	1	1	1	1	Memory Addressing
28	1	0	1	1	1	1	Digital AFT On
29	0	1	1	1	1	1	Band Sequential
30	1	1	1	1	1	1	Automatic Search

**PIN 12-13. AFT1-AFT2 (STOP/AFT INPUTS)**

These pins are enabled during the automatic search and during normal operation, when the digital AFT is enabled (see description of pin 17).

The STOP/AFT inputs are also disabled internally

during any program or band change for the duration of the Mute signal.

These pins work according to the truth table given below :

M49X Pin 12 TDA4433 Pin 2	M49X Pin 13 TDA4433 Pin 6	Function (referred to the tuning voltage)
H	L	Up
L	H	Down
L	L	Middle
H	H	No Operation

These inputs have two different functions depending on whether the system is in the search or in normal operation (AFT control).

The inputs have internal pull-up resistors of 30 K $\Omega$  typ.

A) **Search mode** : after depressing the Automatic search or preset keys, the levels of the signals coming from the TDA4433, applied to these pins, control the search function and determine when the search must stop, i.e. a TV station has been recognized.

The circuit operates in the following sequence (see fig. 12 for reference) :

- 1 - after pressing the search start key the search occurs in the FAST UP mode.
- 2 - eventual transitions available on these inputs are ignored during the first 15 search steps if the system is in the UHF or CATV bands.

If the system operates in VHF I and III the first 60 search steps are ignored. The acceptance delay of 15 (60) search steps has been introduced to prevent the system from stopping at the

previous station.

After this time the FAST UP speed is automatically reduced to half during each UP signal (MEDIUM UP = FAST UP/2).

A DOWN signal preceded by at least an UP signal will set the search to MEDIUM DOWN mode (FAST UP/4).

3 - the next UP signal will switch the search to SLOW UP speed (61 Hz).

At this point the systems is in normal AFT operation.

B) **Digital AFT operation** : when a station is perfectly tuned, the input signals coming from TDA4433 are at middle condition.

If the tuning moves lower than the threshold below 38.9 MHz, the pin 12 is put H and pin 13 is put L ; the 13 bit internal counter is moved SLOW UP speed to increase the varicap voltage.

When a detuning occurs in the opposite direction the input 12 goes Low and 13 goes High and the tuning voltage is decreased with VERY SLOW DOWN speed (7.6 Hz).

The increase or decrease of the tuning voltage is stopped as soon as the input returns to middle conditions.

Therefore during normal operation pins 12 and 13 act as digital AFT control command.

- C) **Recall from memory** : when the digital AFT is enabled and an information is recalled from Memory, a fixed value of 8 steps (~ 31.2 mV) is subtracted from the tuning voltage.

This corresponds to a detuning of 0.6 MHz (UHF) and of 0.3 MHz in VHF III into that part of the IF

response curve which corresponds to the fully transmitted sideband.

At this point the AFT operation takes over as described in point B above and the exact tuning is achieved in about 0.2 sec.

This feature increases the AFT capture range and relaxes the stability requirements of the tuner, voltage references and the D/A converter.

If the Digital AFT is disable (pin 17 at V<sub>SS</sub>), the memory content is read without any change.

Figure 12.

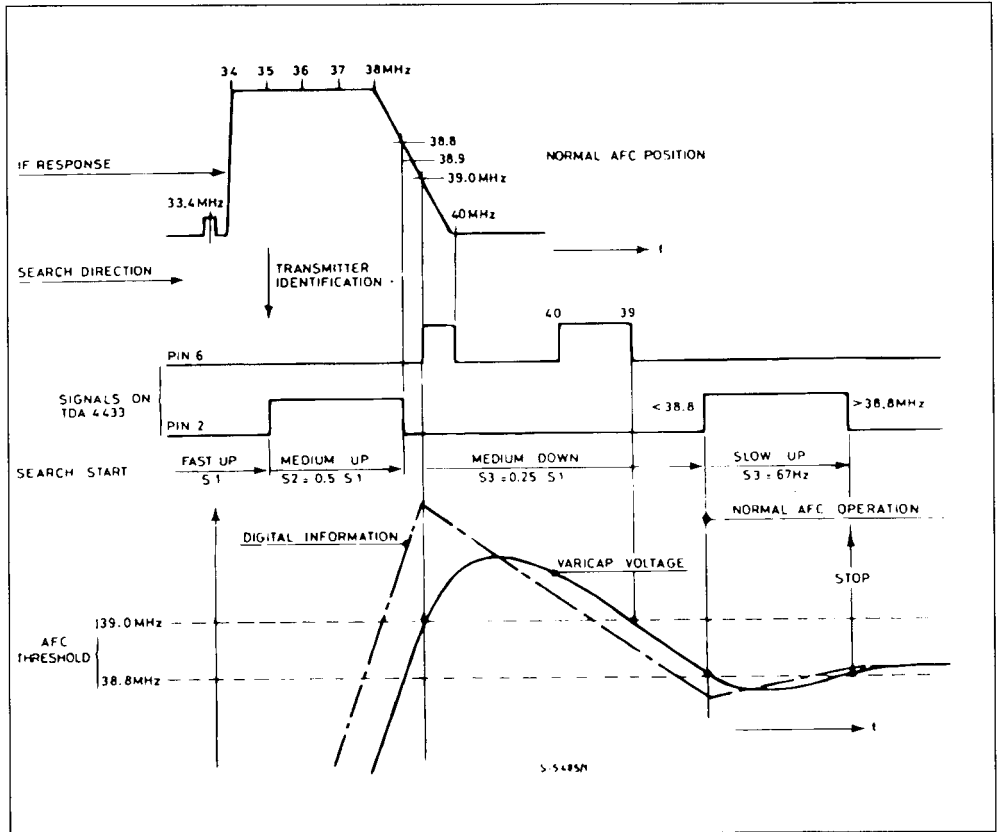

#### PIN 14. SWEEP SEARCH DISPLAY OUTPUT

This output, which is normally Low, goes High during automatic search automatic preset at intervals of 160 ms for about 40 ms to blank the LED of band display.

Figure 13.

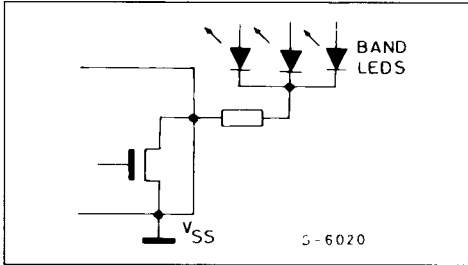

#### PIN 15. VOLUME D/A OUTPUT

This output delivers a square wave signal of 7.8 kHz and duty cycle variable in 63 steps. In case of a continuous command for varying the volume, the duty cycle is changed at the rate of the transmitted sig-

Figure 14.

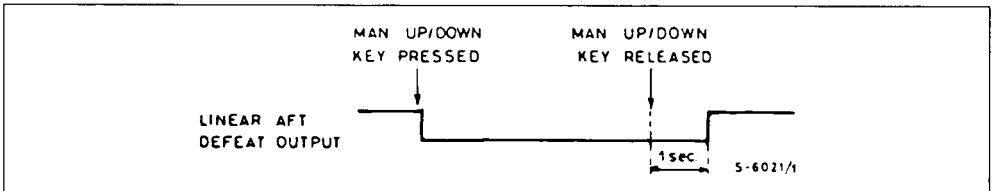

#### PIN 17. DIGITAL AFT ENABLE INPUT

If this input is connected to  $V_{SS}$  (GND), the digital AFT loop is always disabled. If pin 17 is left open or is connected to  $V_{DD}$ , the digital AFT is automatically enabled at power on. When a manual up/down

nal (approximately every 102 ms with  $f_{ref} = 500$  kHz) or every 112 ms if issued locally.

Overflow and underflow protection are provided.

The volume output can be switched to  $V_{SS}$  and reset to the previous level by means of the mute on/off command. It is also reset by the volume Up/Down and the mains on/off commands.

The volume is muted at each mains on and off command for about 1 s during the power on reset time and program change (0.5 s).

At the first power on reset of  $V_{DD1}$  the volume D/A is set at the level 21/64. The last level is preserved until  $V_{DD}$  is not removed.

#### PIN 16. LINEAR AFT DEFEAT OUTPUT

This output is normally High and goes Low when a Man Up/Down command is issued.

It returns High with a 1 second delay from the release of the key, in order to give the user the possibility of the tuning adjustment without the AFT intervention. It goes Low for 0.5 s during program change.

search command is issued, the digital AFT loop is disabled and the digital AFT status output is switched off.

The digital AFT loop is restored by the commands : Digital AFT on/Automatic search/Automatic preset.

PINS 18-19-20-21-22-23-24. (keyboard matrix)

Figure 15.

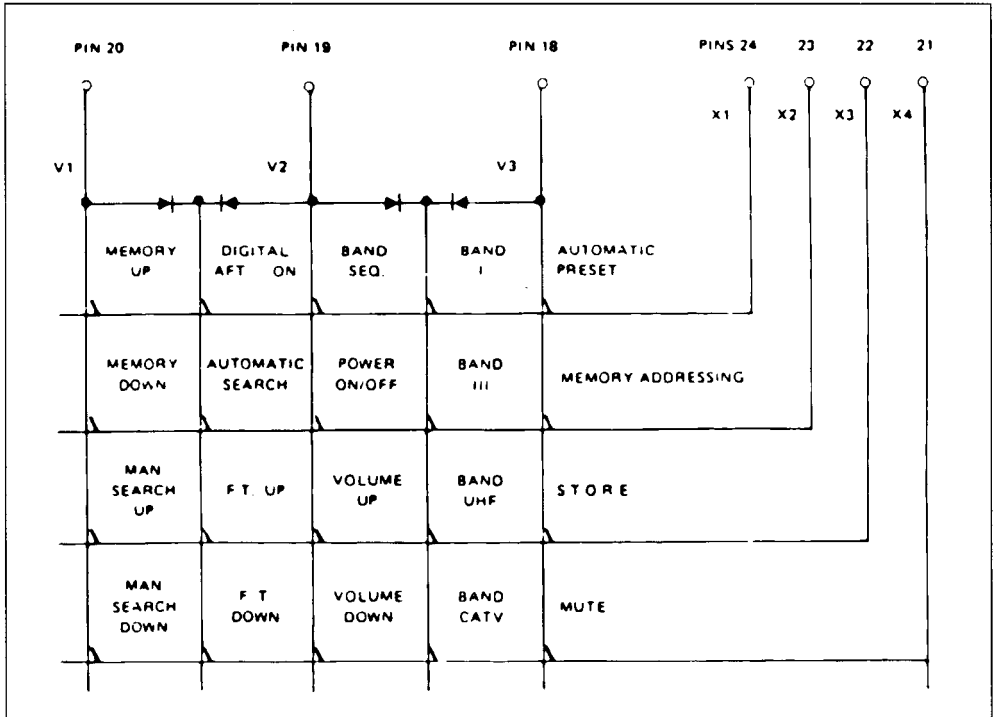

A command is accepted if the corresponding contact has been closed for a minimum time of 30 ms.

Local input commands and I.R. commands have the same priority.

If a complete I.R. command has been received, the local inputs are blocked until the command has been executed and the "end of transmission code" generated.

Viceversa an I.R. signal cannot be decoded until an issued local command has been executed.

#### MEMORY UP/DOWN

Depressing one of these two commands, the memory position is stepped in the UP or DOWN direction.

If the key is kept closed, the channels are stepped UP/DOWN every 0.5 second or every 5 commands from the transmitter.

In the M490B the locations from 11 to 16 can be

skipped in groups of 2 connecting the relevant Y input to GND.

In the M491B the memory locations 9 to 16 are jumped if pin 31 is at GND.

#### BAND SELECTION

The bands can be directly selected or with a step-by-step command with the following sequence :

- VHF I
- CATV
- VHF III
- UHF
- VHF I and so on

Only one band change is performed at each accepted command.

Disabled bands are automatically skipped. A band can be disabled connecting the corresponding output to V<sub>ss</sub>.

## SEARCH MODES

4 modes are available :

- a) automatic search
- b) automatic preset } (digital AFT)
- c) man up/down (digital and linear AFT)
- d) man up/down (linear AFT)

a) **AUTOMATIC SEARCH.** The search starts from the actual tuning and band position. During the search the tuning voltage is always changing from lower to higher voltage levels. When the end of the band is reached the search restarts from the beginning of the next band after a 480 ms interruption with the sequence of step by step band selection. Disable bands are automatically skipped.

The search is stopped when the first station is found or if a channel selection command is given.

Stop of the automatic search is determined by the STOP/AFT inputs controlled by the TDA4433 which converts the AFC-S-curve into an up/down command.

At the end of the search the up/down command controls the correct tuning acting on the counter of the voltage synthesizer (Digital AFT).

It is important to call the attention to the Digital AFT capture range which is larger than the normal linear AFT as shown in fig. 16.

Figure 16.

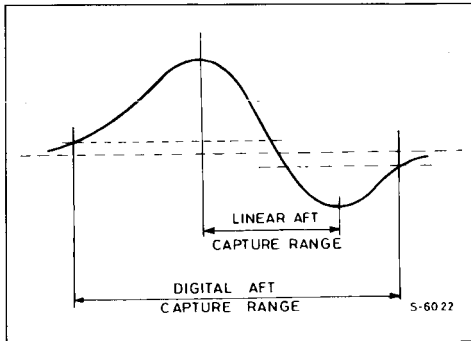

Additionally the use of the Digital AFT allows storage of the tuning information corresponding to the zero point of the AFC-S-curve. This cannot be guaranteed using the Linear AFT method only. The latter is a cheaper system, because it does not require the use of the TDA4433 but it cannot guarantee what described above.

As a result of the use of the Digital AFT, the requirements for stability of the tuner, of the reference volt-

age source and of stability of the D/A converter are less critical.

Tuning speed in automatic search, if no station is found is :

VHF I	8 second
VHF III	8 second
UHF	32 second
CATV	32 second

The tuning and band information can be stored using the store/memory addressing command.

The search can be stopped by a memory selection command.

b) **AUTOMATIC PRESET.** The search starts from the lowest memory address, tuning voltage and VHF I band as described in automatic search mode.

When an active station is encountered, the corresponding tuning and band information is automatically stored in the Non-Volatile Memory.

Afterwards the system starts to search for the next station. The cycle is repeated until all bands have been swept or the tuning information have been stored into all address locations. After completing this cycle the system reads out the tuning information of the lowest address.

c) **MAN UP/DOWN WITH DIGITAL AND LINEAR AFT** (pin 17 at  $V_{DD}$ ). Holding one of these commands pressed, the tuning voltage is increased or decreased.

During this operation, the Digital AFT is automatically defeated and can only be reconnected with the "AFT on" command or by an Automatic search or preset command.

The search speed is kept at minimum (there is no increment with the time)

Band	Sweep Time for the Complete Band	Number of Tuning Steps/Second
VHF I	128 seconds	64
VHF III	128 seconds	64
UHF	512 seconds	16
CATV	512 seconds	16

In case of command received from remote control, the counter is increased/decreased every two received commands.

No band switching is provided at the upper or lower tuning position.

The volume is automatically muted 3 second after the key pressure is immediately restored at the release of the key.

d) **MANUAL UP/DOWN WITH LINEAR AFT** (pin 17 at  $V_{SS}$ ). When this control is used the Digital AFT is disabled.

The Linear AFT output goes low after an up or down command is issued and it remains Low 1 second after the release of the key.

The volume is automatically muted 3 second after the key pressure and is immediately restored at the release of the key.

Tuning speeds are as follows :

Band	Number of Tuning Steps are Second			
	Time 0	After 1 s	After 2 s	After 3 s
VHF I	64	128	256	512
VHF III	64	128	256	512
VHF	16	32	64	128
CATV	16	32	64	128

**FINE TUNING UP/DOWN**

See description of pin 4.

**DIGITAL AFT ON**

See description of pin 17.

**VOLUME UP/DOWN**

See description of pin 15.

**MAINS ON/OFF**

See description of pins 25 and 26.

**STORE COMMANDS**

2 modes of operations are available.

- a) store
- b) memory addressing

In order to protect the memory, the store function is internally disabled after one store cycle.

It is enabled after a program change or a tuning operation (it is not disabled by the Digital AFT control).

a) **STORE**. The tuning information (Tuning D/A, Fine tuning D/A and band) is stored in a previously selected memory address when this command is issued.

b) **MEMORY ADDRESSING**. The tuning information can also be stored with this command followed by the memory position selection.

When this command is accepted all the memory LEDs are blanked.

Selection of the memory position initiates the store operations and restores the display.

**MUTE ON/OFF**

See description of pin 15.

**PIN 25. MAINS ON OPTION INPUT**

If connected to  $V_{SS}$  (GND) the Mains output is auto-

matically switched on when  $V_{DD}$  is applied and memory 1 is read.

If it is connected to  $V_{DD}$  the circuit goes in stand by condition.

**PIN 26. MAINS ON/OFF OUTPUT**

Switch on of the set is controlled by the Mains on command issued for more than 0.3 s. The output transistor is set in the off condition to drive through an integrated pull-up resistor, an external NPN transistor.

**Figure 17.**

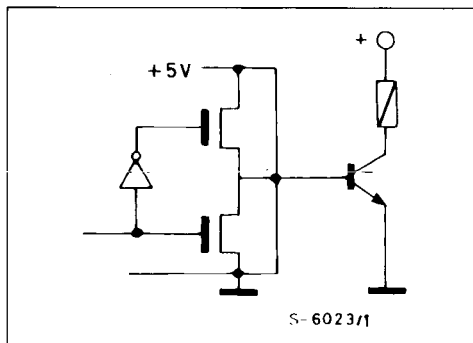

At each Mains on command a memory read out occurs. A  $V_{PP}$  (+25 V) is required for this operation, a 1 second delay starts when the mains output is switched off. For a correct reading of the memory the  $V_{PP}$  supply voltage must reach the value of 25 V within 1 second after a Mains on command.

In case of automatic switch on at power on caused by pin 25 at GND, the total delay is of 1.13 second (0.13s for  $V_{DD}$  power on reset plus 1 second for mains on).

The Mains on/off command, if repeated, will switch the output on (set off).



The last address information is preserved until  $V_{DD}$  is present.

Next Mains on command will switch the set at the previously selected memory address and a read operation will be performed.

PINS 27-28-29-30-33-34-35-36 - MEMORY ADDRESS INPUT/OUTPUT

M490B

Up to 16 Memory locations can be selected.

When  $V_{DD}$  is applied to the circuit the address is automatically preset to the first memory location.

Selection of a memory location is provided connecting one address input line with an X scanning line for more than 30 ms ; this condition is internally latched and the corresponding output buffer is switched on to drive the LED.

Max drive capacity is of 20 mA with  $V_{OL} = 1.5 V$

8 output are provided and 16 channel display is achieved multiplexing the LEDs with the control outputs "Z".

If pins 34, 35, 36 are connected to  $V_{SS}$ , the corresponding memory locations are skipped in case of up/down memory commands.

Figure 18.

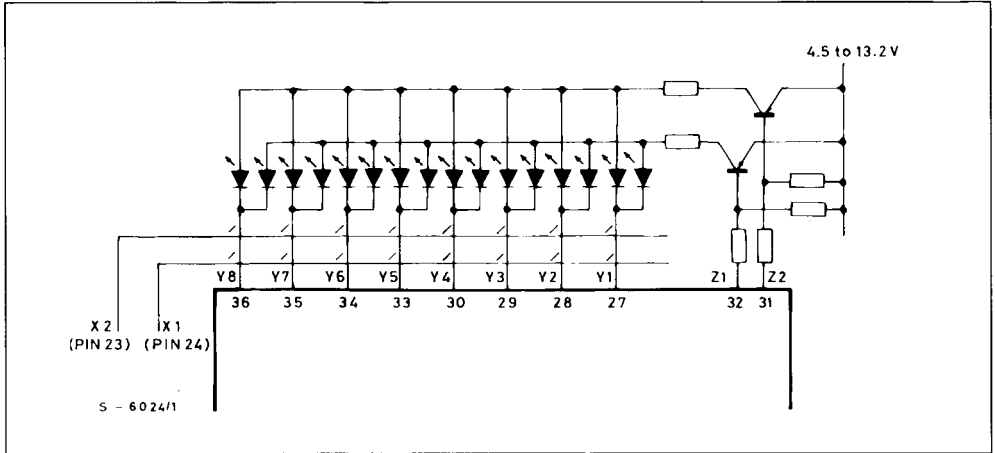

M491B

These pins operate as output only for display of the selected memory location. Max drive capability is of 15 mA/1.2 V with the exception of pin 36 that is of 30 mA/1.5 V.

Direct memory selection is only possible by remote control. A local memory up/down command is available in case of emergency.

Pin 32 must be grounded.

If pin 31 is grounded, the memory position 9 to 16 are skipped in case of memory up/down commands. For normal operation pin 31 can be left open or, better, connected to  $V_{DD}$ .

PINS 31-32

See description of pins 27 to 30 and 33 to 36.

**PINS 37-38-39-40. BAND INPUT/OUTPUT**

These outputs are provided to select up to 4 bands via external PNP's.

If one or more bands have to be skipped, the corresponding outputs have to be short-circuited to V<sub>SS</sub>.

**Figure 19.**

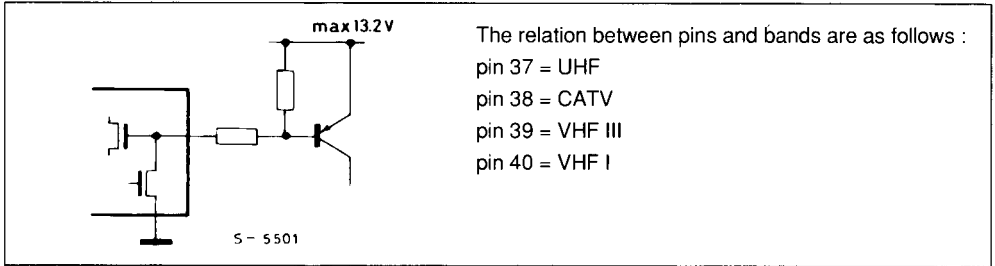

**INPUT/OUTPUT CONFIGURATION**

Output Open Drain.

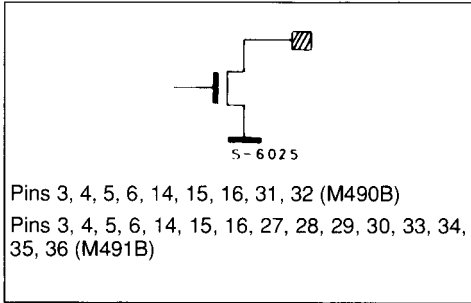

Output Push-pull.

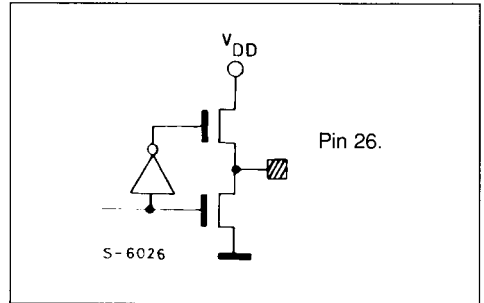

Inputs with Pull-up Load.

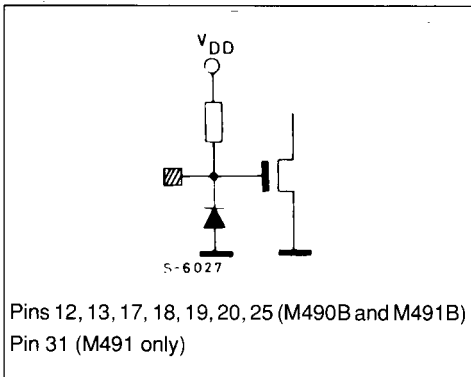

Inputs/Output with Pull-up Resistor (M490B only).

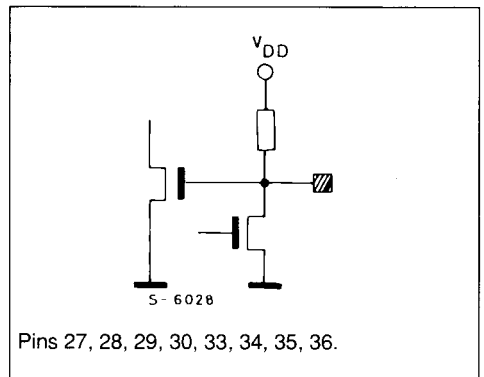

Inputs/Outputs (std).

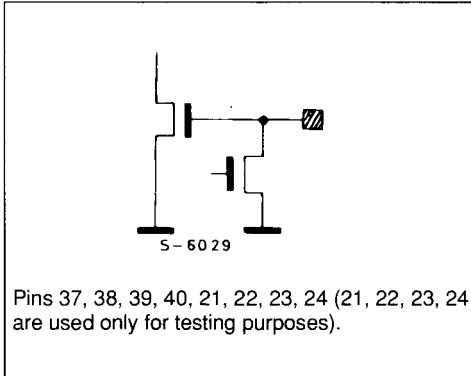

Oscillator.

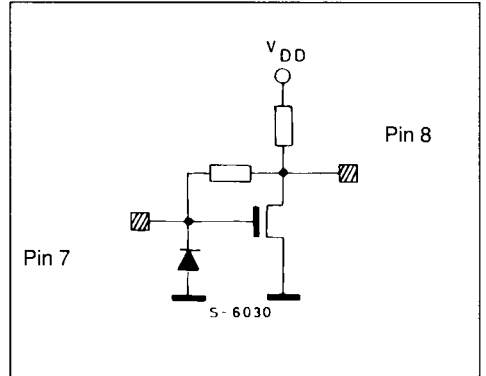

IR Input.

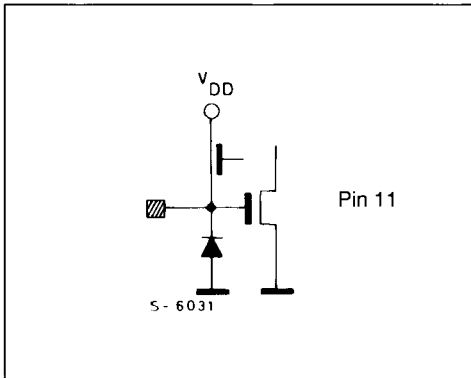





Automatic Search  
Automatic Preset  
Manual Up/Down

} Digital AFT

**LOCAL COMMANDS**

- 1/2 - Memory Up/Down
- 3/4 - Manual Search up/Down
- 5 - Digital AFT On
- 6 - Automatic Search
- 7 - Band Sequential
- 8 - Power On/Off
- 9/10 - Volume Up/Down
- 11 - Automatic Preset
- 12 - Store

