

M51414BSP

NTSC VIDEO CHROMA DEFLECTION

DESCRIPTION

The M51414BSP is a semiconductor integrated circuit that processes video, color, and vertical/horizontal sync signals for NTSC system television sets of average class to top of the line.

FEATURES

- Equipped with delay-line contour adjustment for sharper images.
- Features improved 9MHz (-3dB) video signal circuit frequency characteristics for higher picture quality.
- Employs RGB primary color output; with 9V supply voltage, achieves dynamic range equivalent to that of 12V model. It also has a built-in, on-screen character display circuit and features easy connection with external RGB input, dramatically reducing required peripheral components such as switch circuits, etc.
- Vertical/horizontal count-down by 32fH oscillator eliminates need for adjustment.
- Enables toggling between digital and linear output by vertical output count-down.

APPLICATION

NTSC System Color Televisions

RECOMMENDED OPERATING CONDITION

Supply Voltage Range	8.5~9.5V
Rated Supply Voltage	9.0V(Pin②)
Rated Input Current	20mA(Pin⑦)

PIN CONFIGURATION (TOP VIEW)

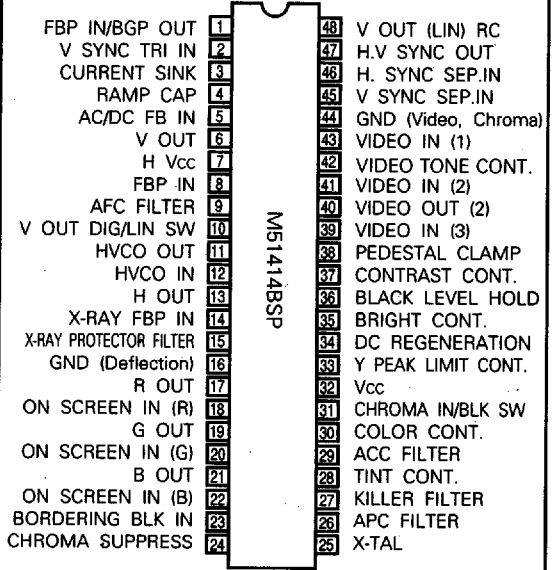

Outline 48P4B

NTSC VIDEO CHROMA DEFLECTION

ELECTRICAL CHARACTERISTICS TEST METHOD

Y_{max} Video Maximum Output

1. Make SG1 input level +20dB.
2. Test amplitude of ㊦ when not blanking.

GY Video Standard Gain

1. Test amplitude of ㊦ when not blanking and make V_{co} the obtained value.
2. $GY=20 \log \frac{V_{co}(mV_{p-p})}{200(mV_{p-p})}$ (dB)

GY_{mid} Video Gain Variation Characteristics-1**GY_{min} Video Gain Variation Characteristics-2****GY_{max} Video Gain Variation Characteristics-3**

1. Make V_{c1}, V_{c2}, and V_{c3} the output amplitude of ㊦ when 37A is 4.5V, 0V, and 9V.

$$2. GY_{mid}=20 \log \frac{V_{c1}}{V_{co}} \text{ (dB),}$$

$$GY_{min}=20 \log \frac{V_{c2}}{V_{co}} \text{ (dB),}$$

$$GY_{max}=20 \log \frac{V_{c3}}{V_{co}} \text{ (dB)}$$

Y_{BRTmid} Brightness Variation Characteristics-1**Y_{BRTmin} Brightness Variation Characteristics-2****Y_{BRTmax} Brightness Variation Characteristics-3**

1. Test DC voltage of ㊦ when not blanking.

Y_H Video Output Maximum Voltage

1. Test DC voltage of ㊦ when not blanking.

Y_{BLC1} Black Level Correction Variation Characteristics-1**Y_{BLC2} Black Level Correction Variation Characteristics-2**

1. Test DC voltage of ㊦ when not blanking.

DG Video Differential Gain Characteristics

1. Make v_{G1} and v_{G2} the output amplitude of ㊦ when ㊦ is 3.2V and 2.9V.

$$2. DG = \frac{|V_{G1}-V_{G2}|}{V_{G2}} \times 100 \text{ (%)}$$

G_{YH} Video High-Pass Standard Gain

1. Test amplitude of ㊦ when not blanking and make V_{Hi} the obtained value.

$$2. G_{YH}=20 \log \frac{V_{Hi}(mV_{p-p})}{100(mV_{p-p})} \text{ (dB)}$$

GT_{mid} Video Tone Variation Characteristics-1**GT_{min} Video Tone Variation Characteristics-2****GT_{max} Video Tone Variation Characteristics-3**

1. Make V_{T0}, V_{T1}, V_{T2}, and V_{T3} the output amplitude of ㊦ when 42A is changed to open, 4.5V, 9V, and 0V.

$$2. GT_{mid}=20 \log \frac{V_{T1}}{V_{T0}} \text{ (dB),}$$

$$GT_{min}=20 \log \frac{V_{T2}}{V_{T0}} \text{ (dB),}$$

$$GT_{max}=20 \log \frac{V_{T3}}{V_{T0}} \text{ (dB)}$$

G_f Video Frequency Characteristics

1. Input SG4 and change the frequency. Make SG4 input frequency the frequency when ㊦ output amplitude is -3dB less than when SG1 was being input.

Y_{HBLK} Horizontal Blanking Operation Voltage

1. Make voltage of 1A the voltage where horizontal blanking for ㊦ ceases as the voltage of 1A is gradually dropped below 9V.

Y_{VBLK} Vertical Blanking Voltage

1. Test DC voltage during vertical blanking of ㊦.

M51414BSP

NTSC VIDEO CHROMA DEFLECTION

Y_{DCREG} DC Playback Ratio Correction Variation Characteristics

1. Test DC voltage variance when ⑳ is not blanking and switch 34 is turned from ON to OFF.

Y_{PLmid} Video Peak Limiter Variation Characteristics-1

Y_{PLmax} Video Peak Limiter Variation Characteristics-2

1. Test DC voltage of ㉑ when not blanking.

T_{BLKV} V Blanking Amplitude

1. Test DC voltage during vertical blanking of ㉑.

Y_{BTH} Black Level Replacement Threshold Voltage

1. Increase voltage of ㉑ from 2.5V.
2. Make Y_{BTH} the voltage of ㉑ when blanking of ㉑ is replaced by black level voltage.

C_{max} Demodulated Maximum Output

1. Test demodulated output amplitude (P-P) of ㉑. (Maximize the output with 35A.)

C_{norm} Demodulated Typical Output

1. Test demodulated output amplitude (P-P) of ㉑.

ACC1 ACC Characteristics-1

ACC2 ACC Characteristics-2

1. Make V_{A0}, V_{A1}, and V_{A2} the demodulated output amplitude of ㉑ when SG5 input level is 0dB, -21dB, and +6dB.

$$ACC1 = 20 \log \frac{V_{A1}}{V_{A0}} \text{ (dB)}$$

$$ACC2 = 20 \log \frac{V_{A2}}{V_{A0}} \text{ (dB)}$$

C_{cmid} Color Control Variation Characteristics-1

C_{cmid} Color Control Variation Characteristics-2

C_{cmid} Color Control Variation Characteristics-3

1. Make V_{CL0}, V_{CL1}, V_{CL2}, and V_{CL3} the demodulated output amplitude of ㉑ when 30A is open, 4.5V, 0V, and 9V.

C_{Umid} Color Tracking Variation Characteristics-1

$$C_{cmid} = 20 \log \frac{V_{CL1}}{V_{CL0}} \text{ (dB)}$$

$$C_{cmid} = 20 \log \frac{V_{CL2}}{V_{CL0}} \text{ (dB)}$$

$$C_{cmid} = 20 \log \frac{V_{CL3}}{V_{CL0}} \text{ (dB)}$$

C_{Umin} Color Tracking Variation Characteristics-2

C_{Umax} Color Tracking Variation Characteristics-3

1. Make V_{U0}, V_{U1}, V_{U2} and V_{U3} the demodulated output amplitude ㉑ when 37A is open, 4.5V, 0V, 9V.

$$C_{Umid} = 20 \log \frac{V_{U1}}{V_{U0}} \text{ (dB)}$$

$$C_{Umin} = 20 \log \frac{V_{U2}}{V_{U0}} \text{ (dB)}$$

$$C_{Umax} = 20 \log \frac{V_{U3}}{V_{U0}} \text{ (dB)}$$

f_{pc1} APC Pull-In Range-1

f_{pc2} APC Pull-In Range-2

1. Frequency range where the ㉑ output signal changes from off to on as the burst and chroma frequency (f_{sb}=f_{sc}) are altered during SG7 input. The standard value is 3.579545MHz.

KIL Killer Operation Input Level

1. SG6 input level where the ㉑ output signal changes from off on as SG6 input level is gradually decreased.

D_{KIL} Killer Color Residual

1. Output signal amplitude for ㉑ when e_b=0mV_{P-P}, e_c=100mV_{P-P}, and frequency f_{sc}=3.579545MHz during SG6 input.

R/B Demodulated Output Amplitude Ratio-1

G/B Demodulated Output Amplitude Ratio-2

1. Make D_{B-Y}, D_{R-Y}, and D_{G-Y} the output amplitude of ㉑, ㉒, and ㉓.

$$R/B = \frac{D_{R-Y}}{D_{B-Y}}, \quad G/B = \frac{D_{G-Y}}{D_{B-Y}}$$

R_{oc}, G_{oc}, B_{oc}

R, G, B Output DC Voltage

1. Test DC voltage for ㉒, ㉓, and ㉔ when not blanking.

D_{offset} R, G, B Output DC Offset

1. Calculate the electric potential differences of ㉒ and ㉓, ㉓ and ㉔, and ㉔ and ㉒, using the testing values obtained in C-17.

C_{leak} Demodulated Output Carrier Leak

1. Test the carrier element output by ⑰, ⑱, and ㉑.

T Tint Control Variance

1. Using an oscilloscope (X-Y display), test the variation of amplitude phase of the ⑱ and ㉑ output signals when 28A is 0V and 9V.

T_{min} Tint Control Characteristics-1**T_{max} Tint Control Characteristics-2**

1. Using an oscilloscope (X-Y display), test the variation of amplitude phase of the ⑱ and ㉑ output signals when 28A is 4.5V, 0V, and 9V. Use the phase at 4.5V as reference.

R/T_a, G/T_a, B/T_a**R, G, B Output Pin Voltage Temperature Coefficient****D_{Offset/T_a} Voltage Difference Temperature Coefficient Between R, G, B Output Pins**

1. The temperature variation range should be of -20 ~ +65°C.

θ_{R-Y} Demodulated Phase Angle-1

1. Make θ_{R-Y} the phase difference of ⑰ and ㉑.

θ_{G-Y} Demodulated Phase Angle-2

2. Make θ_{G-Y} the phase difference of ⑱ and ㉑.

ΔV_{Y-C} Color Tracking Characteristics

1. Input SG1 from B, and make V_{CT1} and V_{CT2} the output amplitude of ㉑ when 37A is 4.0V and 4.5V.
2. Input SG5 from A, and make V_{CT3} and V_{CT4} the output amplitude of ㉑ when 37A is 4.0V and 4.5V.

$$3. \Delta V_{Y-C} = 20 \log \frac{V_{CT1}}{V_{CT2}} - 20 \log \frac{V_{CT3}}{V_{CT4}} \text{ (dB)}$$

CS Color Signal Suppression Characteristics

1. Input APL 10% SG14 from B, and make V_{CS1} the demodulated output amplitude of ㉑.
2. Input APL 35% SG14 from B, and make V_{CS2} the demodulated output amplitude of ㉑.

$$3. CS = 20 \log \frac{V_{CS1}}{V_{CS2}} \text{ (dB)}$$

OS On-Screen Characteristics

1. DC voltage variance of ⑰, ⑱, and ㉑ when not blanking and when the voltages of ⑱, ㉑, and ㉒ are changed from 0V to 3V.

BLK_{ON} On-Screen Blanking Threshold Voltage**B-BLK Trim-Blanking Threshold Voltage**

1. Applied voltage of each pin when ⑰, ⑱, and ㉑ are engaged in the full period of blanking as voltage of ⑱, ㉑, ㉒, and ㉓ is increased from 0V.

T_{BLK-F} On-Screen Blanking Amplitude-1**T_{BLK-B} On-Screen Blanking Amplitude-2**

1. Input SG15 from D.

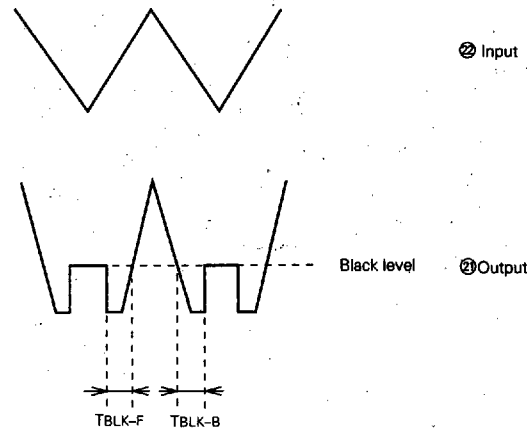
**V_{OSHV} Horizontal/Vertical Sync Output Amplitude****f_H/T_a Oscillator Frequency Temperature Coefficient**

1. The temperature variation range should be of -20 ~ +65°C.

V_{7min} Oscillator Starting Pin ⑦ Voltage

1. Gradually increase the applied voltage of 7A.
2. V_{7min} is the voltage of ⑦ when the cycle of ⑬ output waveform becomes approx. 63.5μs.

f_{PH-1} Pull-In Range 1

1. Increase the SG11 input signal frequency gradually so that the input signal and ⑬ output become unsynchronized.
2. Decreasing the input signal frequency, make this the difference between the input signal frequency and oscillator frequency (f_H) precisely when the input signal and ⑬ output become synchronized.
3. Perform the same procedure for the lower side pull-in range.

M51414BSP

NTSC VIDEO CHROMA DEFLECTION

TH H. Pulse Amplitude

V_{Hmin}, V_{Hmax}

H. Output Voltage

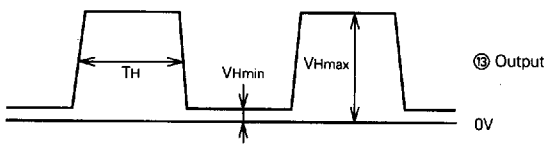

TV1 V. Pulse Amplitude-1

TV2 V. Pulse Amplitude-2



V_{OD/LV} V_{out} Digital/Linear Switching Voltage

1. Set voltage of ⑩ to 0V.
2. Make V_{OD/LV} the applied voltage of ⑩ precisely when waveform shown on the right is obtained from ⑬ output as voltage of ⑩ is increased.

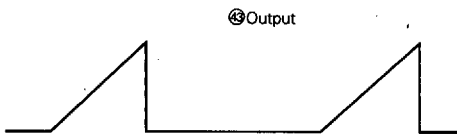

f_{PV} Pull-In Range

1. Increase the input signal frequency so that the SG12 input signal and ⑬ output become unsynchronized.
2. Decrease the input signal gradually and make f_{PV} the input signal frequency precisely when input signal and ⑬ output become synchronized.

V_{OH4} Ramp Maximum Output Voltage

V_{OL4} Ramp Minimum Output Voltage

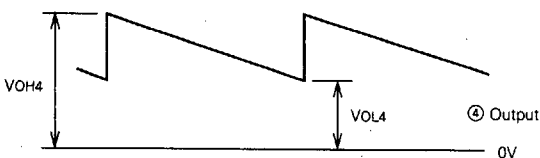

T_{GP} Burst Gate Pulse Position

T_{BGP1} Burst Gate Pulse Timing-1

T_{BGP2} Burst Gate Pulse Timing-2

V_{FBP} FBP Clamp Voltage

V_{BGP} Burst Gate Pulse Voltage

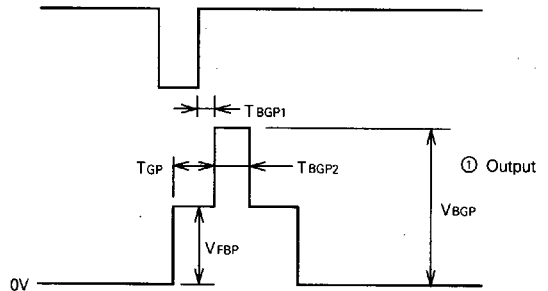

V_{THAFC} AFC Detector Voltage

1. Set voltage of 8A to 9V.
2. Make V_{THAFC} the applied voltage of 8A precisely when AFC begins to behave abnormally as voltage of 8A is gradually increased.

V_{Vmax} Vertical Output Maximum Voltage

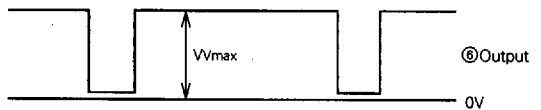

I_{SSH} Sync Separation Input Sensitivity Current (Horizontal)

1. Set I_S to 0mA.
2. Make I_{SSH} the value of I_S when the voltage of ⑱ is in the area of 3V as I_S is gradually increased.

I_{SSV} Sync Separation Input Sensitivity Current (Vertical)

1. Same as I_{SSH}.

V_{14P} Overvoltage Protector Circuit Operating Voltage

1. Set voltage of ⑭ to 0V.
2. As voltage of ⑭ is gradually increased, ⑲ begins blanking and output waveform of ⑬ ceases. Make V_{14P} the applied voltage of ⑭ when output waveform of ⑬ ceases.

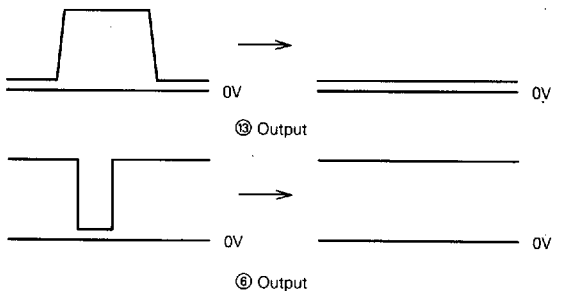

3. In order to perform the following test, first turn off all applied voltages.

V_{32P1} Supply Voltage Detector Circuit Operating Voltage-1

1. Set voltage of 32A to 9V.
2. Gradually increase voltage of 32A and make V_{32P1} the applied voltage of 32A when status becomes as described in step 2 of item V_{14P}.
3. In order to perform the following test, first turn OFF all applied voltages.





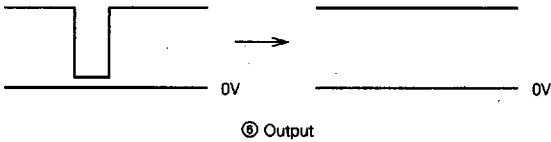

V_{32P2} Supply Voltage Detector Circuit Operating Voltage-2

1. Set voltage of 32A to 9V.
2. As voltage of 32A is gradually decreased, ⑥ output ceases. Make V_{32P2} the applied voltage of 32A when DC voltage becomes approx. 1.3V.

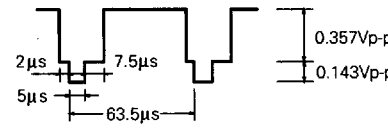
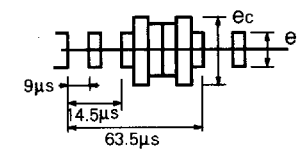

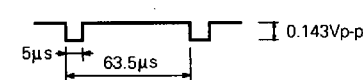
NTSC VIDEO CHROMA DEFLECTION

INPUT SIGNAL

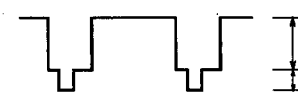
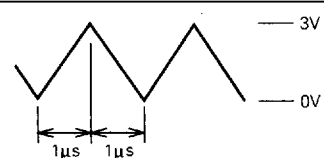
SG No.	Signal Name	Signals
SG1	200 kHz Sine Wave	Establish 0 dB as 200 mVp-p.
SG2	APL 100% Standard Signal	
SG3	2 MHz Sine Wave	Establish 0 dB as 100 mVp-p.
SG4	Sine Wave	Sine wave with variable frequency where 0 dB is set to 200 mVp-p.
SG5	Chroma Standard Signal (Color Bar)	 <p> f_{SB}: Burst Signal Frequency f_{SC}: Chroma Signal Frequency f_{SB} = f_{SC} = 3.579545 MHz 0 dB: e_b = 50 mVp-p e_c = 100 mVp-p </p>
SG6	Chroma Signal 1	 <p> f_{SB} = f_{SC} = 3.579545 MHz (Same Phase) 0 dB: e_b = 50 mVp-p e_c = 100 mVp-p </p>
SG7	Chroma Signal 2	Chroma signal with variable frequency where all burst and chroma signals are the same phase with respect to chroma signal 1 of SG6.
SG8	Chroma Signal 3	Chroma signal where f _{SB} = 3.579545 MHz, f _{SC} = 3.529545 MHz (f _{SB} - 50 kHz) with respect to chroma signal 1 of SG6.
SG9	Standard Sync Signal	
SG10	APL 50% Standard Signal	
SG11	Sync Signal 1	 <p>Duty 90% Pulse Signal</p>
SG12	Sync Signal 2	 <p>Duty 95% Pulse Signal</p>
SG13	5MHz Sine Wave	Establish 0 dB as 100 mVp-p.
SG14	Variable APL Standard Signal	 <p>Variable (0.357 Vp-p should be APL 100%.)</p>
SG15	Delta Wave (Input signal for on-screen character display)	

TYPICAL CHARACTERISTICS

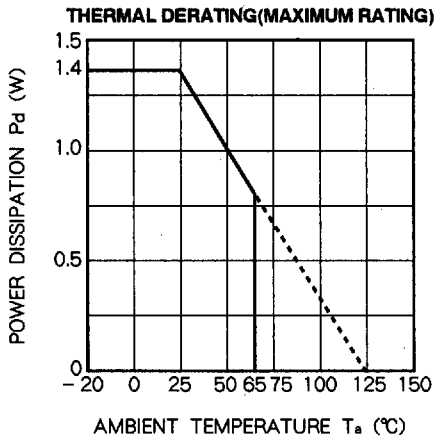

M51414BSP

NTSC VIDEO CHROMA DEFLECTION

APPLICATION EXAMPLE

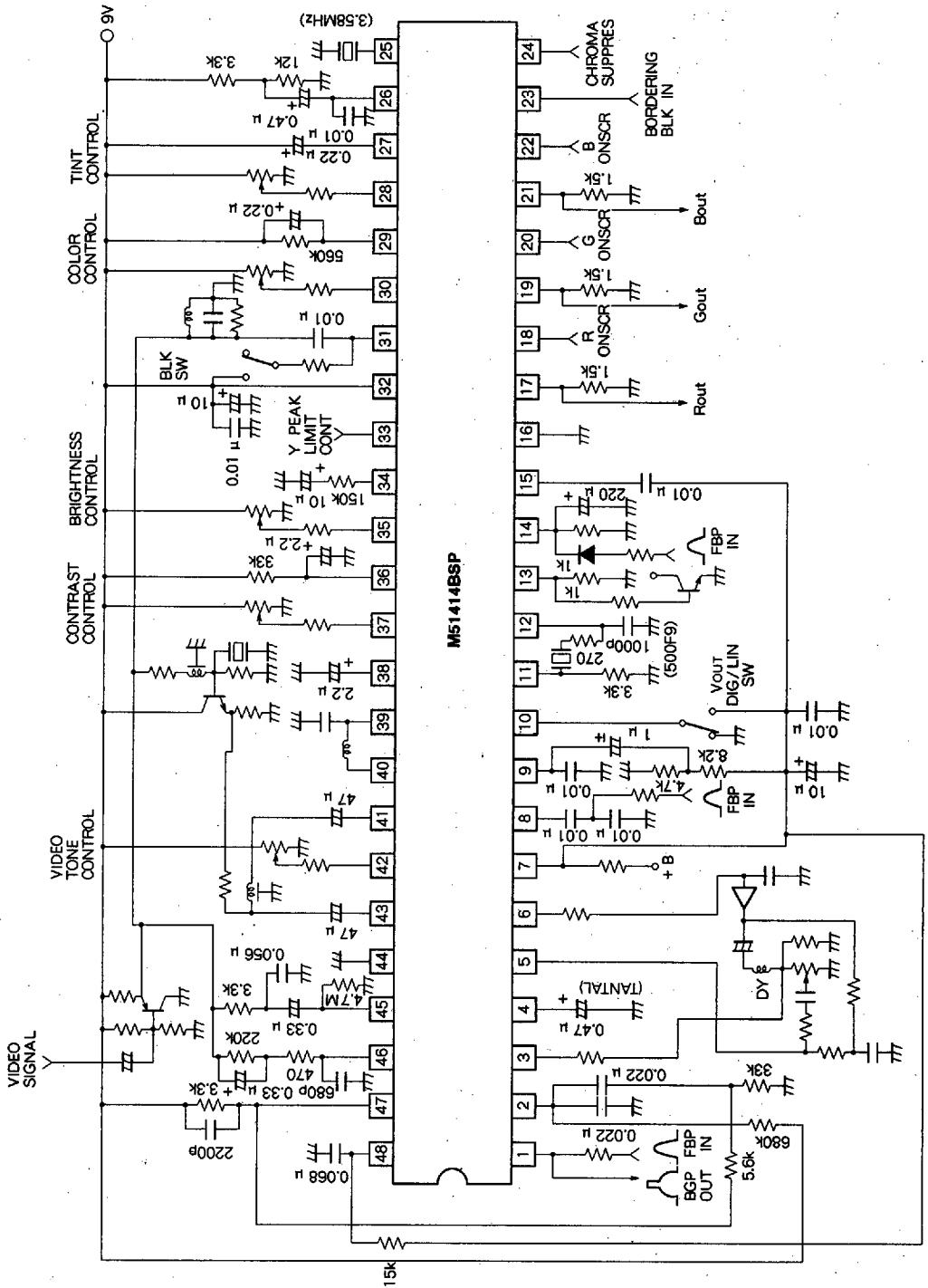

Units Resistance: Ω
Capacitance: F

M51414BSP

NTSC VIDEO CHROMA DEFLECTION

DESCRIPTION OF PIN

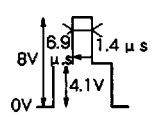
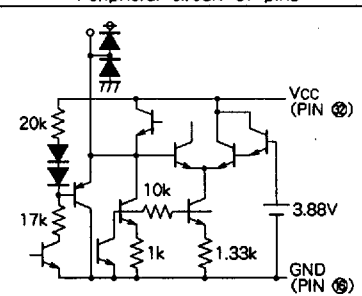
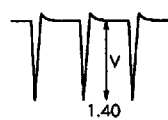
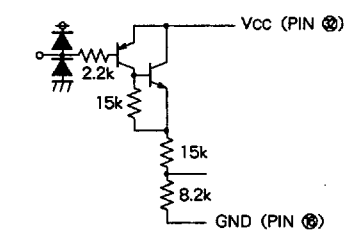
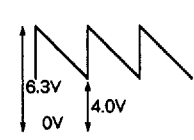
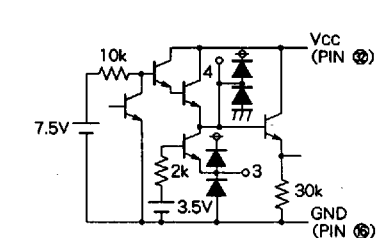
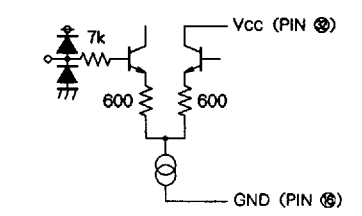
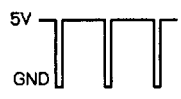
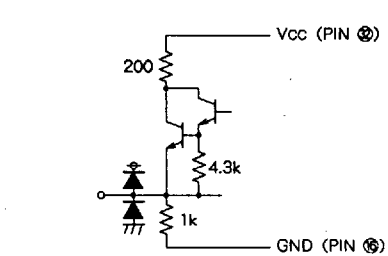
Pin No.	Name	Description	Peripheral circuit of pins	DC voltage(V)
①	FBP IN/ BGP OUT	 <p>Output as sand castle of BGP and FBP.</p>		—
②	V SYNC TRI IN			—
③ ④	CURRENT SINK RAMP CAP	<p>Amplitude of ramp is altered by external R.</p> 		2.75
⑤	AC/DC FB IN	—		—
⑥	V OUT			—

M51414BSP

NTSC VIDEO CHROMA DEFLECTION

DESCRIPTION OF PIN (cont.)

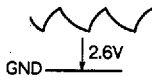
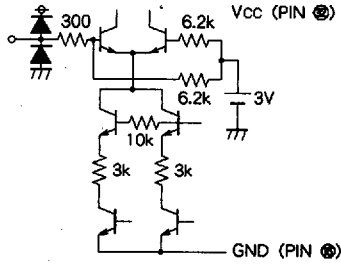
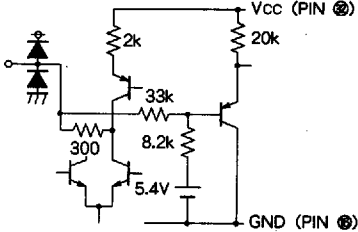
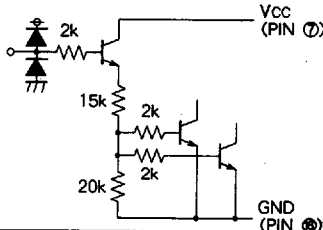
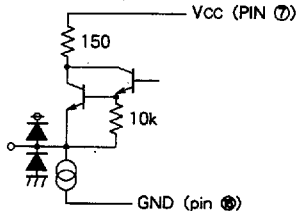
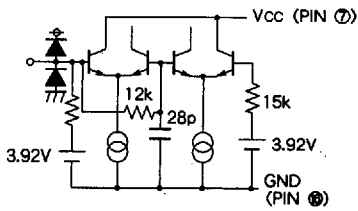
Pin No.	Name	Description	Peripheral circuit of pins	DC voltage(V)
⑦	H Vcc	Set external r so that 25 mA is input to ic component.	-	-
⑧	FBP IN			3.0
⑨	AFC FILTER	—		5.4
⑩	V OUT DIG/LIN SW	2.1V or higher : lin operation 2.1V or lower : dig operation		—
⑪	HVCO OUT	—		7
⑫	HVCO IN	—		3.9

M51414BSP

NTSC VIDEO CHROMA DEFLECTION

DESCRIPTION OF PIN (cont.)

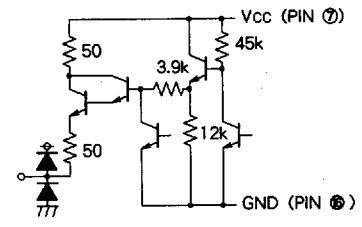
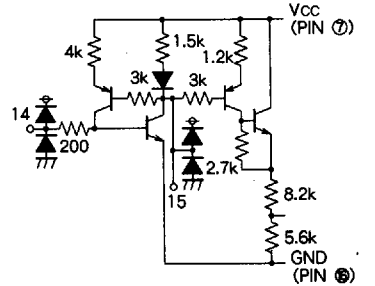
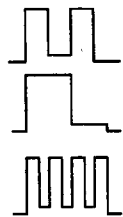
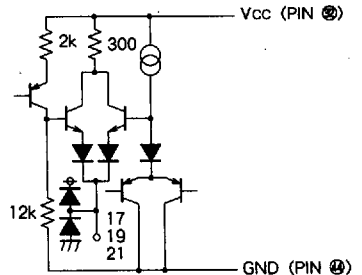
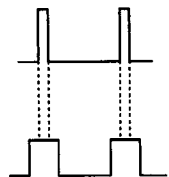
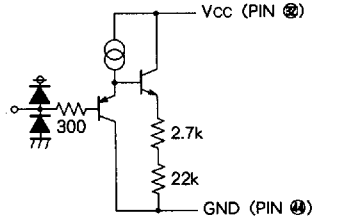
Pin No.	Name	Description	Peripheral circuit of pins	DC voltage(V)
13	H OUT			—
14	X - RAY PROTECTOR	—		—
15	X - RAY PROTECTOR FILTER	—		—
16	GND (Deflection)	—	—	—
17	R OUT			—
19	G OUT			—
21	B OUT			—
18	ON SCREEN IN (R)			—
20	ON SCREEN IN (G)			—
22	ON CSREEN IN (B)			—
23	BORDERING BLK IN			—

M51414BSP

NTSC VIDEO CHROMA DEFLECTION

DESCRIPTION OF PIN (cont.)

Pin No.	Name	Description	Peripheral circuit of pins	DC voltage(V)
②	CHROMA SUPPRESS	With pin open and low luminance, color saturation becomes -3dB. There is no suppression if grounded.		—
⑤	X-TAL	Connect to 3.58MHz X'tal.		—
⑥	APC FILTER	—		—
⑦	KILLER FILTER	—		—
⑧	TINT CONT.	Tint control pin		4.5

M51414BSP

NTSC VIDEO CHROMA DEFLECTION

DESCRIPTION OF PIN (cont.)

Pin No.	Name	Description	Periphera' circuit of pins	DC voltage (V)
②	ACC FILTER	—		—
③	COLOR CONT.	Color control pin		4.5
⑪	CHROMA IN/BLK SW	If pin voltage is raised above 4.5V, BLK is not engaged for RGB output.		2.65
⑫	Vcc	—	—	—
⑬	Y PEAK LIMIT CONT.	Controls peak of Y. If pin voltage is increased, limiter is engaged on the black side.		0 ⑮ 8
⑭	DC REGENERATION	Dc playback ratio can be varied by external CR.		—
⑮	BRIGHT CONT.	Bright control pin		3.1

M51414BSP

NTSC VIDEO CHROMA DEFLECTION

DESCRIPTION OF PIN (cont.)

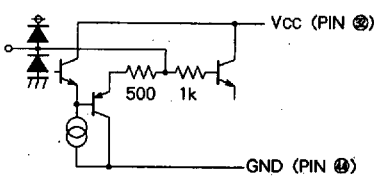
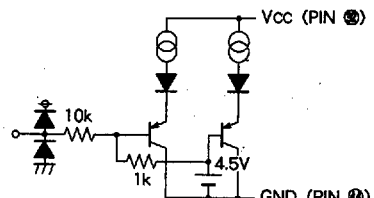
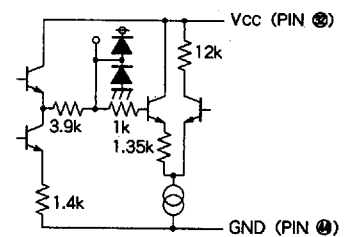
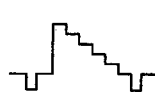
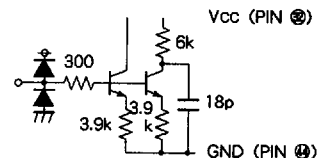
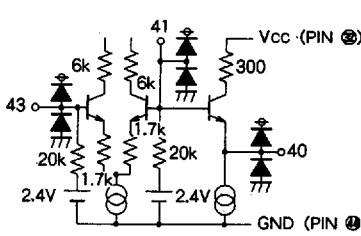
Pin No.	Name	Description	Peripheral circuit of pins	DC voltage(V)
35	BLACK LEVEL HOLD	Detects the blackest part of image.		—
37	CONTRAST CONT.	Contrast control pin		4.5
38	PEDESTAL CLAMP	—		—
39	VIDEO IN (3)			—
40	VIDEO OUT (2)	—		1.6
41	VIDEO IN (2)	—		2.4
43	VIDEO IN (1)	—		2.4

M51414BSP

NTSC VIDEO CHROMA DEFLECTION

DESCRIPTION OF PIN (cont.)

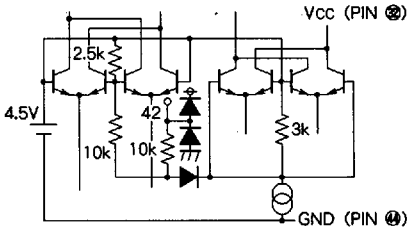
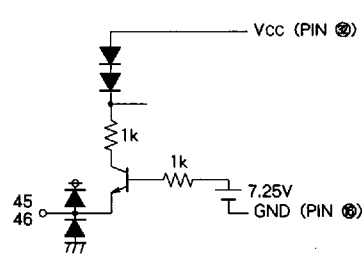
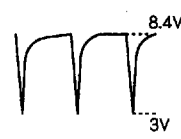
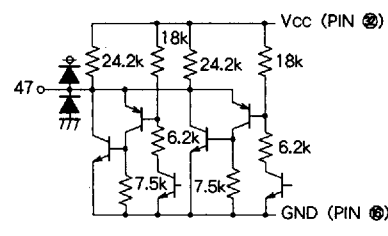
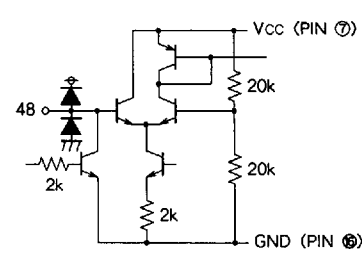
Pin No.	Name	Description	Peripheral circuit of pins	DC voltage(V)
42	VIDEO TONE CONT.	If voltage of tone control pin is decreased, high frequency increases.		4.5
44	GND (Video, Chroma)	—	—	—
45 46	Y SYNC SEP.IN H SYNC SEP.IN	—		6.5
47	H.V SYNC OUT			—
48	V OUT (LIN) RC	Vout pulse amplitude is determined by external CR.		—