

MITSUBISHI LSIs M5M5165P, FP-70, -10, -12, -15, -70L, -10L, -12L, -15L

65536-BIT (8192-WORD BY 8-BIT) CMOS STATIC RAM

DESCRIPTION

The M5M5165P, FP is a 65536-bit CMOS static RAM organized as 8192 words by 8 bits which is fabricated using high-performance double polysilicon CMOS technology. The use of resistive load NMOS cells and CMOS periphery result in a high-density and low-power static RAM. It is ideal for the memory systems which require simple interface.

The stand-by current is low enough for a battery back-up application.

FEATURES

Type	Access time (max)	Power supply current	
		Active (max)	Stand-by (max)
M5M5165P, FP-70	70ns	50mA	2mA
M5M5165P, FP-10	100ns		
M5M5165P, FP-12	120ns		
M5M5165P, FP-15	150ns		
M5M5165P, FP-70L	70ns		
M5M5165P, FP-10L	100ns	20 μ A	(V _{CC} =5.5V)
M5M5165P, FP-12L	120ns	10 μ A	(V _{CC} =3.0V)
M5M5165P, FP-15L	150ns		

- Single +5V Power Supply
- Fully Static Operation: No Clocks, No Refresh
- Data-Hold on +2V Power Supply
- Directly TTL Compatible: All Inputs and Outputs
- Three-State Outputs: OR-tie Capability
- Simple Memory Expansion by \overline{S}_1 , S_2
- \overline{OE} Prevents Data Contention in The I/O Bus
- Common Data I/O

APPLICATION

Small Capacity Memory Units.

FUNCTION

The operation mode of the M5M5165P, FP is determined by a combination of the device control inputs \overline{S}_1 , S_2 , \overline{W}

PIN CONFIGURATION (TOP VIEW)

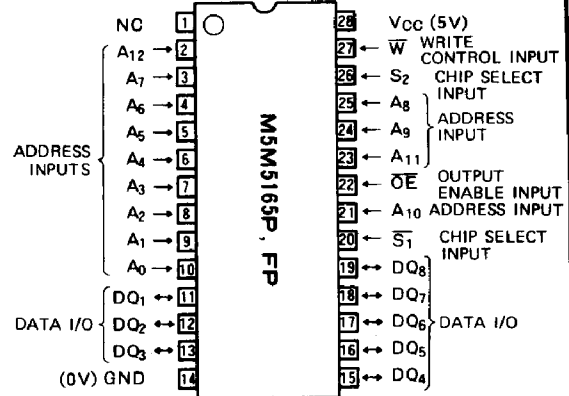

Outline 28P4 (DIP)
28P2W-C (SOP)

and \overline{OE} . Each mode is summarized in the function table. (see next page)

A write cycle is executed whenever the low level \overline{W} overlaps with the low level \overline{S}_1 and the high level S_2 . The address must be set up before the write cycle and must be stable during the entire cycle. The data is latched into a cell on the trailing edge of \overline{W} , \overline{S}_1 or S_2 , whichever occurs first, requiring the set-up and hold time relative to these edge to be maintained. The Output enable input \overline{OE} directly controls the output stage. Setting the \overline{OE} at a high level, the output stage is in a high-impedance state, and the data bus contention problem in the write cycle is eliminated.

A read cycle is executed by setting \overline{W} at a high level and \overline{OE} at a low level while \overline{S}_1 and S_2 are in an active state ($\overline{S}_1=L$,

BLOCK DIAGRAM

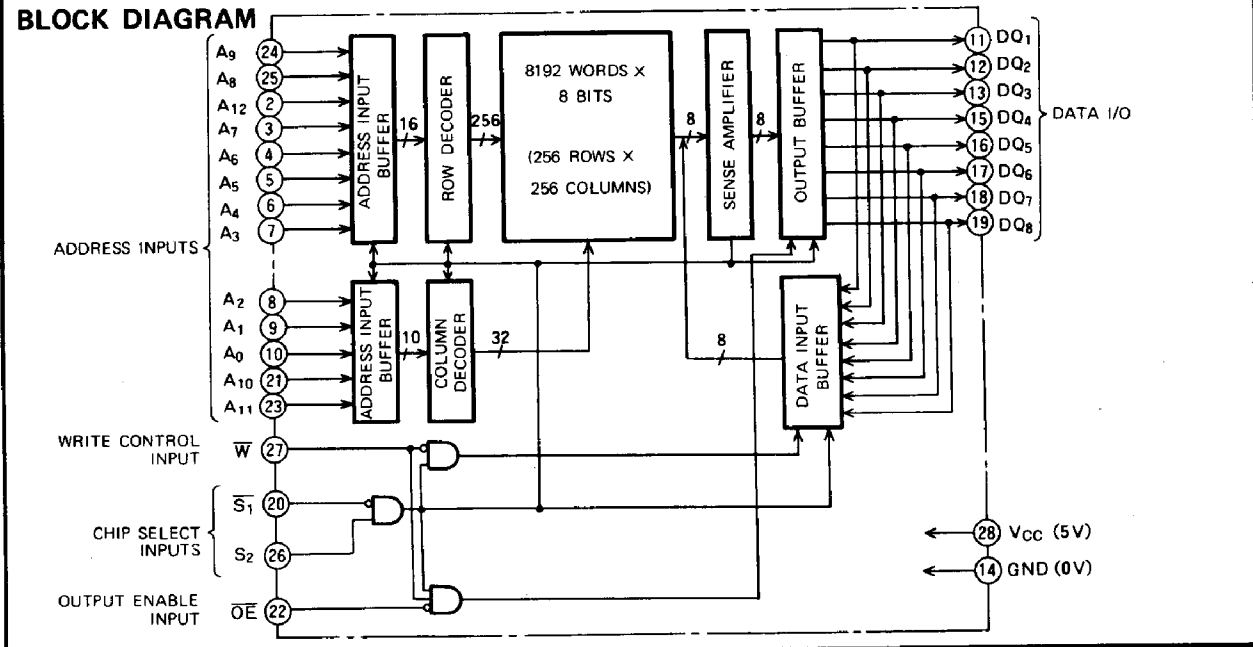

M5M5165P, FP-70, -10, -12, -15, -70L, -10L, -12L, -15L

65536-BIT (8192-WORD BY 8-BIT) CMOS STATIC RAM

S₂=H)

When setting $\overline{S_1}$ at a high level or S₂ at a low level, the chip is in a non-selectable mode in which both reading and writing are disabled. In this mode, the output stage is in a high-impedance state, allowing OR-tie with other chips and memory expansion by $\overline{S_1}$ and S₂. The power supply current is reduced as low as the stand-by current which is specified as I_{CC3} or I_{CC4}, and the memory data can be held at +2V power supply, enabling battery back-up operation during power failure or power-down operation in the non-selected mode.

FUNCTION TABLE

$\overline{S_1}$	S ₂	\overline{W}	\overline{OE}	Mode	DQ	I _{CC}
X	L	X	X	Non selection	high-impedance	Standby
H	X	X	X	Non selection	high-impedance	Standby
L	H	L	X	Write	D _{IN}	Active
L	H	H	L	Read	D _{OUT}	Active
L	H	H	H		high-impedance	Active

ABSOLUTE MAXIMUM RATINGS

Symbol	Parameter	Conditions	Ratings	Unit
V _{CC}	Supply voltage	With respect to GND	-0.3 ~ 7	V
V _I	Input voltage		-0.3 ~ V _{CC} +0.3	V
V _O	Output voltage		0 ~ V _{CC}	V
P _d	Power dissipation	T _a =25°C	700	mW
T _{opr}	Operating temperature		0 ~ 70	°C
T _{stg}	Storage temperature		-65 ~ 150	°C

ELECTRICAL CHARACTERISTICS (T_a=0 ~ 70°C, V_{CC}=5V ± 10%, unless otherwise noted)

Symbol	Parameter	Test conditions	Limits			Unit
			Min	Typ	Max	
V _{IH}	High input voltage		2.2		V _{CC} +0.3	V
V _{IL}	Low input voltage		-0.3		0.8	V
V _{OH}	High output voltage	I _{OH} =-1mA	2.4			V
V _{OL}	Low output voltage	I _{OL} =2mA			0.4	V
I _I	Input current	V _I =0 ~ V _{CC}			±1	μA
I _{OZH}	High level output current in off-state	$\overline{S_1}=V_{IH}$ or S ₂ =V _{IL} or $\overline{OE}=V_{IH}$ V _{I/O} =0 ~ V _{CC}			1	μA
I _{OZL}	Low level output current in off-state				-1	μA
I _{CC1}	Active supply current	$\overline{S_1} \leq 0.2$, S ₂ ≥ V _{CC} -0.2 Output open Other inputs ≤ 0.2 or ≥ V _{CC} -0.2		30	45	mA
I _{CC2}	Active supply current	$\overline{S_1}=V_{IL}$ or S ₂ =V _{IH} Output open Other inputs = V _{IH}		35	50	mA
I _{CC3}	Stand-by supply current	① S ₂ ≤ 0.2V, Other inputs = 0 ~ V _{CC} ② $\overline{S_1} \geq V_{CC}-0.2V$, S ₂ ≥ V _{CC} -0.2V, Other inputs = 0 ~ V _{CC}	P, FP		2	mA
			P, FP-L		20	μA
I _{CC4}	Stand-by supply current	S ₂ =V _{IL} , $\overline{S_1}=V_{IH}$, Other inputs=0 ~ V _{CC}			3	mA
C _i	Input capacitance (T _a =25°C)	V _I =GND, V _i =25mVrms, f=1MHz			6	pF
C _o	Output capacitance (T _a =25°C)	V _O =GND, V _O =25mVrms, f=1MHz			8	pF

Note 1 Direction for current flowing into IC is indicated as positive (no mark)
 2 Typical value is V_{CC}=5V, T_a=25°C

M5M5165P, FP-70, -10, -12, -15, -70L, -10L, -12L, -15L

65536-BIT (8192-WORD BY 8-BIT) CMOS STATIC RAM

SWITCHING CHARACTERISTICS (T_a = 0 ~ 70°C, V_{CC} = 5V ± 10%, unless otherwise noted)

Read cycle

Symbol	Parameter	Limits												Unit
		M5M5165P, FP-70 M5M5165P, FP-70L			M5M5165P, FP-10 M5M5165P, FP-10L			M5M5165P, FP-12 M5M5165P, FP-12L			M5M5165P, FP-15 M5M5165P, FP-15L			
		Min	Typ	Max	Min	Typ	Max	Min	Typ	Max	Min	Typ	Max	
t _{CR}	Read cycle time	70			100			120			150			ns
t _a (A)	Address access time			70			100			120			150	ns
t _a (S ₁)	Chip select 1 access time			70			100			120			150	ns
t _a (S ₂)	Chip select 2 access time			70			100			120			150	ns
t _a (OE)	Output enable access time			35			50			60			70	ns
t _{dis} (S ₁)	Output disable time after $\overline{S_1}$ high			30			35			40			50	ns
t _{dis} (S ₂)	Output disable time after S ₂ low			30			35			40			50	ns
t _{dis} (OE)	Output disable time after \overline{OE} high			30			35			40			50	ns
t _{en} (S ₁)	Output enable time after $\overline{S_1}$ low	5			10			10			10			ns
t _{en} (S ₂)	Output enable time after S ₂ high	5			10			10			10			ns
t _{en} (OE)	Output enable time after \overline{OE} low	5			10			10			10			ns
t _v (A)	Data valid time after address change	20			20			20			20			ns

TIMING REQUIREMENTS (T_a = 0 ~ 70°C, V_{CC} = 5V ± 10%, unless otherwise noted)

Write cycle

Symbol	Parameter	Limits												Unit
		M5M5165P, FP-70 M5M5165P, FP-70L			M5M5165P, FP-10 M5M5165P, FP-10L			M5M5165P, FP-12 M5M5165P, FP-12L			M5M5165P, FP-15 M5M5165P, FP-15L			
		Min	Typ	Max	Min	Typ	Max	Min	Typ	Max	Min	Typ	Max	
t _{OW}	Write cycle time	70			100			120			150			ns
t _w (W)	Write pulse width	40			60			70			90			ns
t _{su} (A)	Address set up time	0			0			0			0			ns
t _{su} (S)	Chip select set up time	65			80			85			100			ns
t _{su} (D)	Data set up time	30			35			40			50			ns
t _h (D)	Data hold time	5			5			5			5			ns
t _{rec} (W)	Write recovery time	5			5			10			10			ns
t _{dis} (W)	Output disable time after \overline{W} low	0		30			35			40			50	ns
t _{dis} (OE)	Output disable time after \overline{OE} high	0		30			35			40			50	ns
t _{en} (W)	Output enable time after \overline{W} high	5			10			10			10			ns
t _{en} (OE)	Output enable time after \overline{OE} low	5			10			10			10			ns

65536-BIT (8192-WORD BY 8-BIT) CMOS STATIC RAM

TIMING DIAGRAM
Read cycle

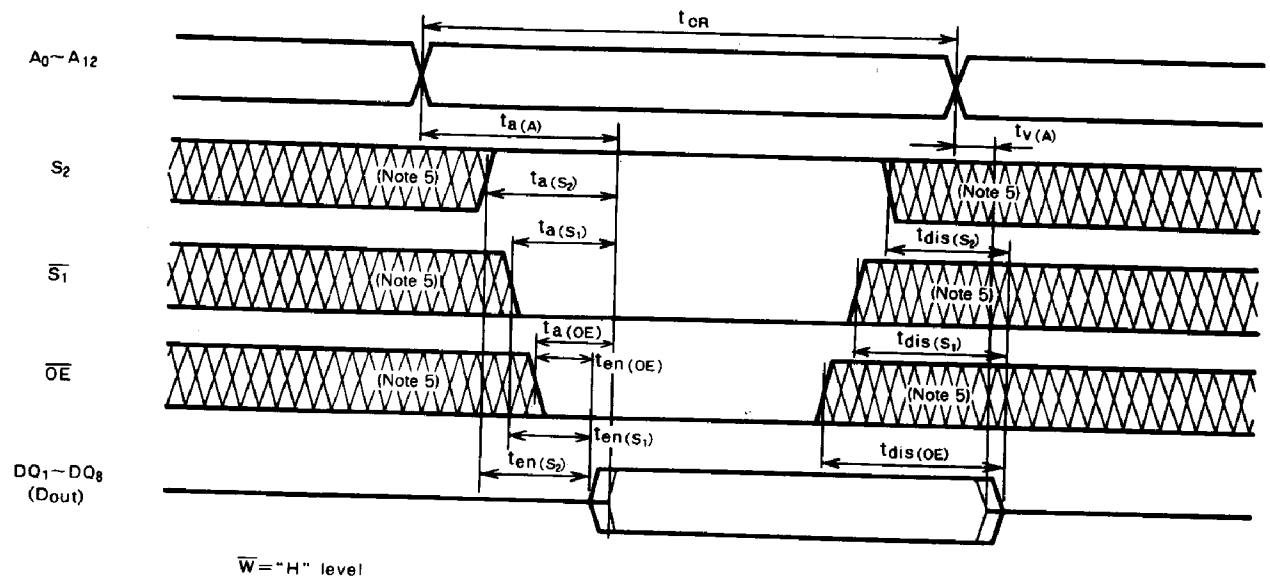

Write cycle (\overline{W} control)

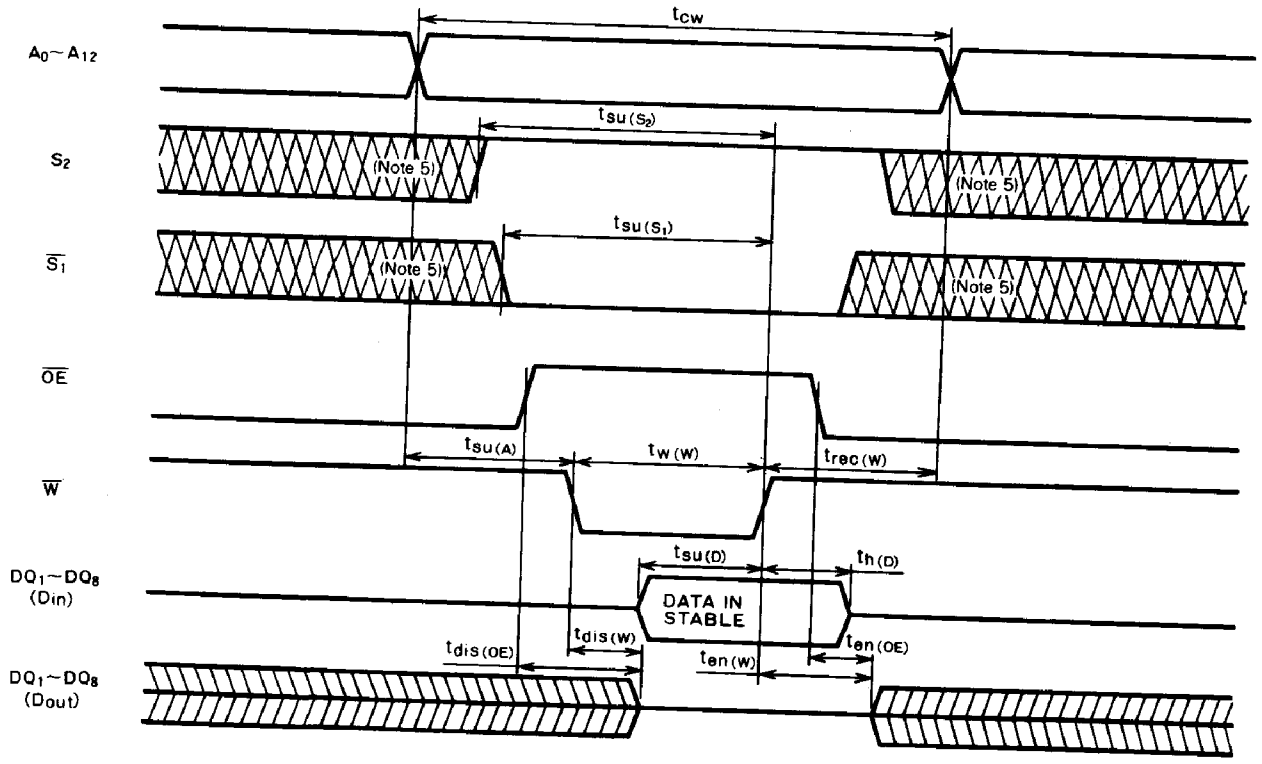

M5M5165P, FP-70, -10, -12, -15, -70L, -10L, -12L, -15L

65536-BIT (8192-WORD BY 8-BIT) CMOS STATIC RAM

Write cycle (S control)

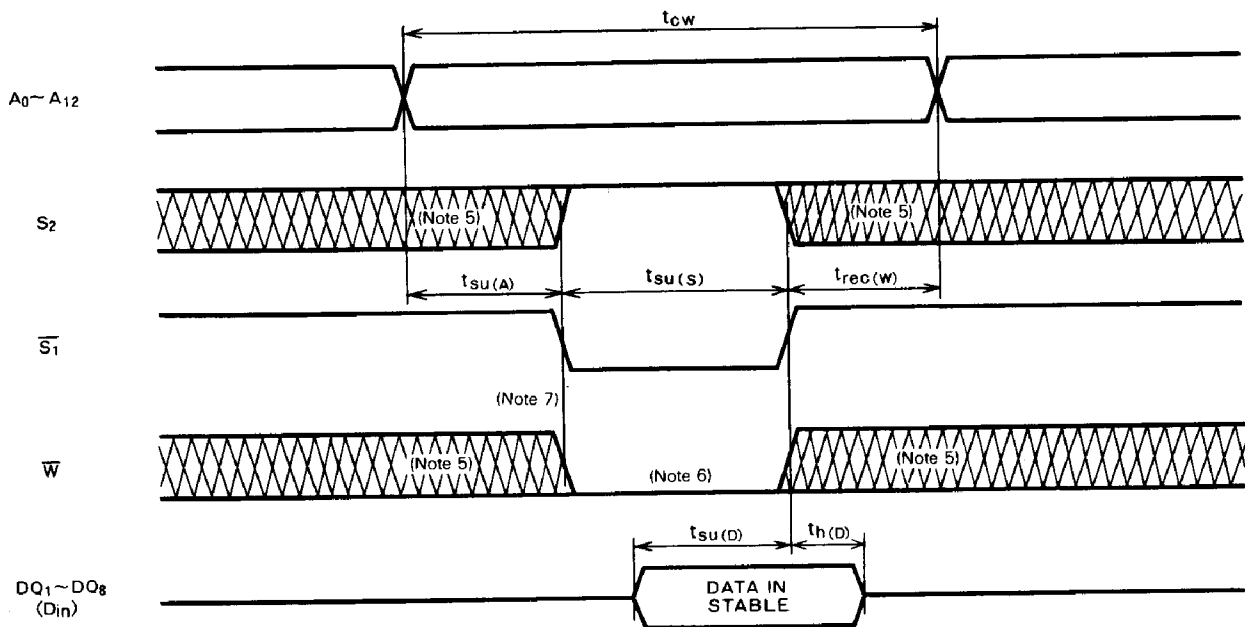

Note 4: Test condition

Input pulse level $V_{IH} = 2.4V, V_{IL} = 0.6V$

Input rise and fall time 10ns

Reference level $V_{OH} = V_{OL} = 1.5V$

Transition is measured $\pm 500mV$ from steady state voltage. (for t_{en}, t_{dis})

Output loads Fig. 1, $C_L = 100pF$ (P, FP-10, -12, -15, -10L, -12L, -15L)

$C_L = 30pF$ (P, FP-70, -70L)

$C_L = 5pF$ (for t_{en}, t_{dis})

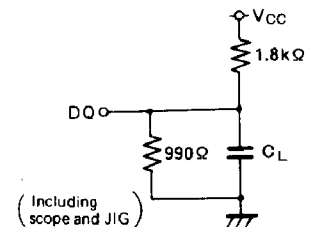

Fig. 1 Output load

Note 5: Hatching indicates the state is don't care.

6: Writing is executed while S_2 high overlaps S_1 and \overline{W} low.

7: If \overline{W} goes low simultaneously with or prior to S_1 low or S_2 high, the output remains in the high-impedance state.

8: Don't apply inverted phase signal externally when DQ pin is in output mode.

M5M5165P, FP-70, -10, -12, -15, -70L, -10L, -12L, -15L

65536-BIT (8192-WORD BY 8-BIT) CMOS STATIC RAM

POWER DOWN CHARACTERISTICS

ELECTRICAL CHARACTERISTICS (Ta = 0 ~ 70°C, unless otherwise noted)

Symbol	Parameter	Test conditions	Limits			Unit
			Min	Typ	Max	
V _{CC(PD)}	Power down supply voltage		2			V
V _I (\overline{S}_1)	Chip select input \overline{S}_1	2.2V ≤ V _{CC(PD)}	2.2			V
		2V ≤ V _{CC(PD)} ≤ 2.2V		V _{CC(PD)}		
V _I (S ₂)	Chip select input S ₂	4.5V ≤ V _{CC(PD)}			0.8	V
		V _{CC(PD)} < 4.5V			0.2	
I _{CC(PD)}	Power down supply current	V _{CC} = 3V, Other inputs = 3V	P, FP		2	mA
			P, FP-L		10 *	μA

Note 3: When \overline{S}_1 is operated at 2.2V (V_{IH min}) and the supply voltage is between 4.5V and 2.4V, supply current is defined as I_{CC4}.

*: I_{CC(PD)} = 1 μA at Ta = 25°C

TIMING REQUIREMENTS (Ta = 0 ~ 70°C, unless otherwise noted)

Symbol	Parameter	Test conditions	Limits			Unit
			Min	Typ	Max	
t _{SU(PD)}	Power down setup time		0			ns
t _{REC(PD)}	Power down recovery time		t _{CR}			ns

POWER DOWN CHARACTERISTICS

\overline{S}_1 control

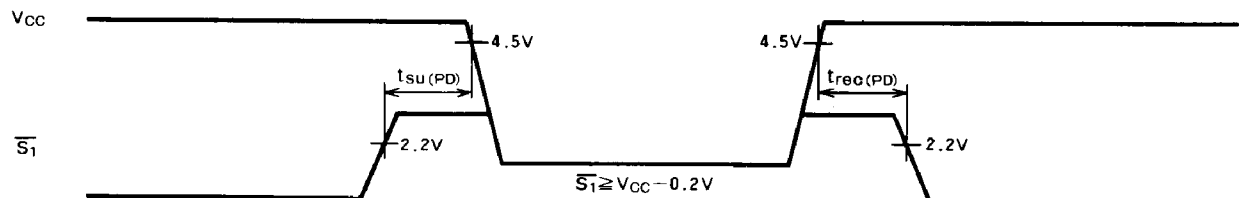

S₂ control

