

DESCRIPTION

The M61206FP is designed to provide a solution to NTSC color television system. It is an I²C bus controlled NTSC 1 chip.

It consists of various processing blocks such as power supply, video IF, sound IF, luminance, chrominance, OSD display, interface, H and V deflection.

At each block, I²C control is possible and a total of 62 parameters can be controlled by I²C bus.

FEATURES

- Various signal output for Intelligent Monitoring function
- Alignment-free sound demodulator
- Built-in H OSC resonator
- Built-in sync sep.(auto-slicer type)
- Built-in black peak hold capacitor
- ACL / ABCL
- Vertical count-down circuit
- Built-in vertical saw tooth generator
- Mute filter integrated
- PLL-SPLIT SIF system with FM receiving function
- H&V pulse output for OSD
- Built-in MCU reset circuit
- fsc output
- Built-in 5V(MCU,1CHIP) & 8V regulator

RECOMMENDED OPERATING CONDITIONS

Supply voltage	4.75V to 5.25V	(pins 2, 3, 23 and 24)
	7.6V to 8.4V	(pins 18, 19, 44, and 45)
	8.3V to 9.1V	(pin 55)
Rated supply voltage	5.0V	(pins 2, 3, 23 and 24)
	8.0V	(pins 18, 19, 44 and 45)
	8.7V	(pin 55)
Maximum output current	4.0mA	(pin 7)

APPLICATION

NTSC type color TV, projector

M61206FP

NTSC TV SIGNAL PROCESSOR

PIN CONFIGURATION (TOP VIEW)

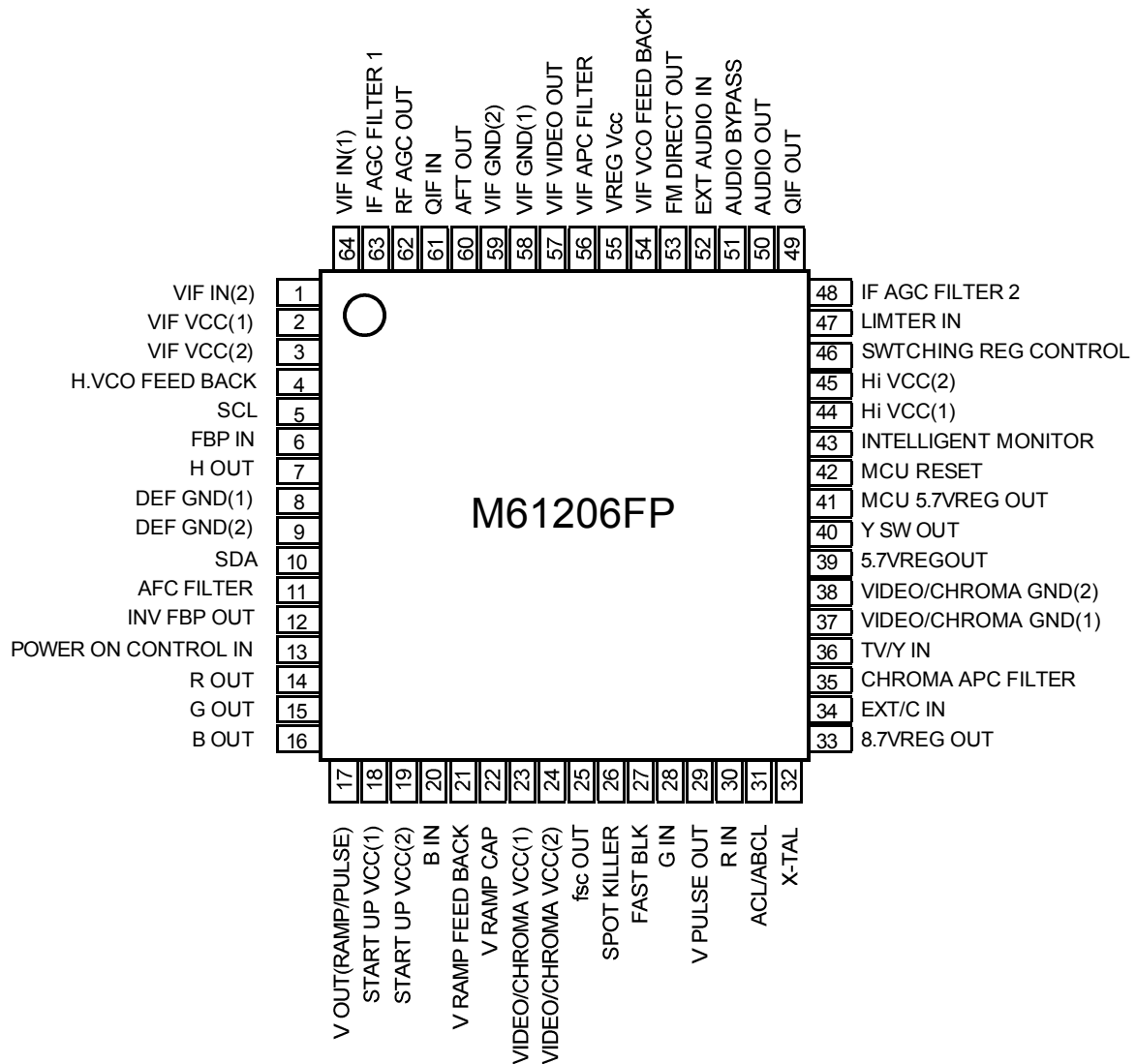

BLOCK DIAGRAM

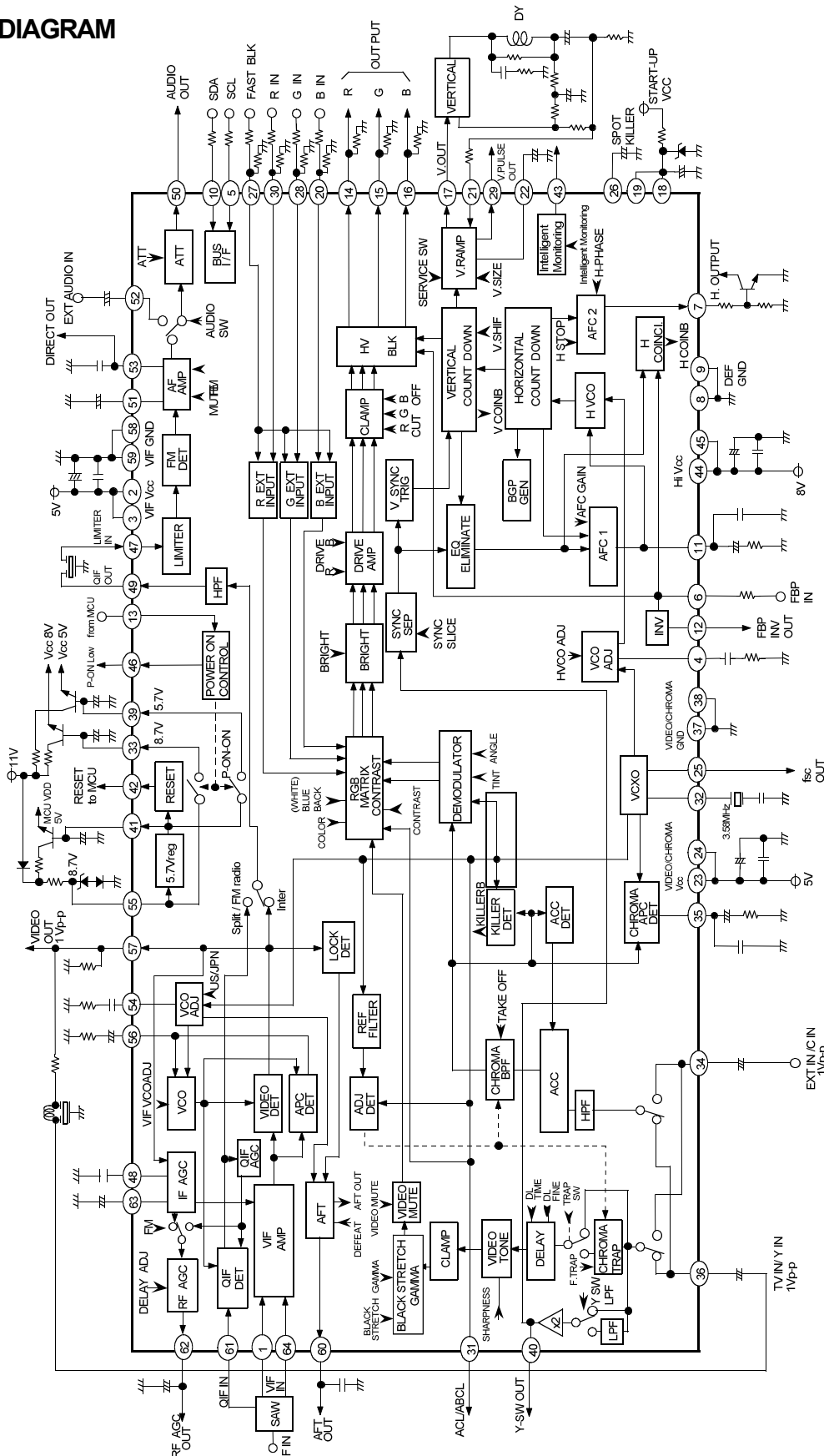

ABSOLUTE MAXIMUM RATINGS

Symbol	Parameter	Ratings	Unit
Vcc	Supply voltage	6.0, 10.0	V
Pd	Power dissipation	1325	mW
Kt	Thermal derating	10.6	mW/°C
Topr	Operating temperature	-20 to 65	°C
Tstg	Storage temperature	-40 to 150	°C

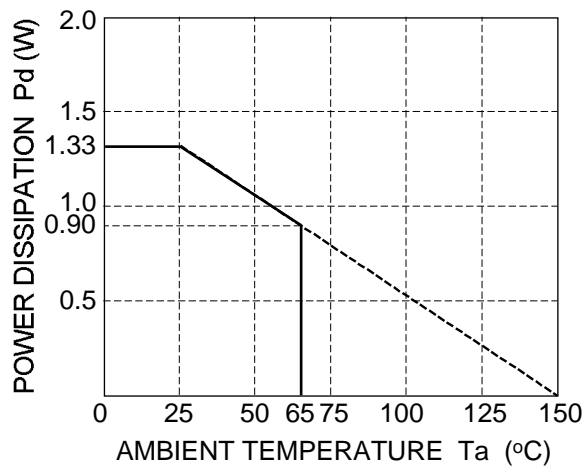
TYPICAL CHARACTERISTICS**THERMAL DERATING (MAXIMUM RATING)**

M61206FP

NTSC TV SIGNAL PROCESSOR

(1) SLAVE ADDRESS= BAH(WRITE), BBH(READ)

A6	A5	A4	A3	A2	A1	A0	R/W
1	0	1	1	1	0	1	1/0

(2) WRITE TABLE(input bytes)

SUB ADDRESS		DATA								INITIAL		
HEX	BIN	D7	D6	D5	D4	D3	D2	D1	D0			
00H	00000000	SPLIT	RF Delay Adj								40H	
		0	1	0	0	0	0	0	0			
01H	00000001	OSD level	VIF VCO ADJ								20H	
		0	0	1	0	0	0	0	0			
02H	00000010	Video Mute	Audio EXT	Force S.Killer	TRAP Off	Video T Sharp	ABCL	Y DL Fine Adj	Take Off	00H		
		0	0	0	0	0	0	0	0			
03H	00000011	Audio Mute	Audio ATT								00H	
		0	0	0	0	0	0	0	0			
04H	00000100	ABCL Gain	AFT Defeat	Video Tone								20H
		0	0	V1	V0	V0	V0	V0	V0			
05H	00000101	EXTRGB C. Clip	Contrast Control								40H	
		V0	V1	V0	V0	V0	V0	V0	V0			
06H	00000110	VIF Video Out Gain			Y/C	Black Stretch Off	EXT	Y DL Time Adj			80H	
		1	0	0	V0	0	V0	0	0			
07H	00000111	VIF Defeat	Tint Control								40H	
		0	V1	V0	V0	V0	V0	V0	V0			
08H	00001000	Blue Back	Color Control								40H	
		V0	V1	V0	V0	V0	V0	V0	V0			
09H	00001001	AFC2 H Phase				(not assigned)			AFC2 Gain	F8H		
		1	1	1	1	1	0	0				
0AH	00001010	Brightness Control								80H		
		V1	V0	V0	V0	V0	V0	V0	V0			
0BH	00001011	V-free	Drive(R)								40H	
		0	1	0	0	0	0	0	0			
0CH	00001100	FM Radio	Drive(B)								40H	
		0	1	0	0	0	0	0	0			
0DH	00001101	Cut Off(R)								80H		
		1	0	0	0	0	0	0	0			
0EH	00001110	Cut Off(G)								80H		
		1	0	0	0	0	0	0	0			
0FH	00001111	Cut Off(B)								80H		
		1	0	0	0	0	0	0	0			
10H	00010000	White Back	S.Slice Down1	H VCO Adj			Test1	Ramp Stop	AutoSliceDown	24H		
		0	0	1	0	0	1	0	0			
11H	00010001	(inhibited)		V-Size								20H
		0	0	1	0	0	0	0	0			
12H	00010010	Monitoring				Gamma Control			TRAP Fine Adj		00H	
		0	0	0	0	0	0	0	0			
13H	00010011	H-free	V.1Window	AFC Gain	H Start	Service SW	V Shift				00H	
		0	0	0	0	0	0	0	0			
14H	00010100	FBP Vth L	YSW LPF	Black Stretch Charge	S.Slice Down2	FM Station Level				04H		
		0	0	0	0	1	0	0	0			
15H	00010101	H Phase MSB	(inhibited)	fsc free	Analog OSD	Force MONO	Force COLOR	C.Angle 95	Killer level	40H		
		0	1	0	0	0	0	0	0			
16H	00010110	Test2										00H
		0	0									
17H	00010111	Test3										
		0	0									
18H	00011000	(not assigned)										
		0	0									
19H	00011001	(not assigned)										
		0	0									
1AH	00011010	(not assigned)										
		0	0									
1BH	00011011	Test4										
		0	0									
1CH	00011100	Black Stretch Discharge										
		0	0									

NOTE: V0 / V1 ==> V- LATCH BIT

(3) READ TABLE (output bytes)

SUB ADDRESS	D7	D6	D5	D4	D3	D2	D1	D0
00H	00000000	KILLERB	FM STDETB	VCOINB	STDETB	AFT0	AFT1	HCOINB (not assigned)

WRITE

	FUNCTION	BIT	SUB ADD	DATA	DISCRIPTION	INITIAL	NOTE
VIF	RF Delay Adj	7	00H	D0-D6	RF AGC Delay Point Adjustment by 7bit DAC	1000000	
	VIF VCO Adj	6	10H	D0-D5	VIF VCO Free-running Frequency Adjustment by 5bit DAC	100000	
	VIF Freq 58.75	1	01H	D6	VIF Frequency Selector 0: 45.75MHz, 1: 58.75MHz	000	
	VIF Video Out Gain	3	06H	D5-D7	VIF Video det output Amplitude Adjustment by 3bit DAC	100	
	AFT Defeat	1	04H	D6	AFT OUT ON/OFF(Defeat) switch 0: AFT ON (Non Defeat), 1: Defeat	0	
	VIF Defeat	1	07H	D7	VIF AGC Gain Normal/Minimum switch 0: AGC Function, 1: Defeat(Minimum Gain)	0	
SPL	SPLIT	1	00H	D7	Inter Carrier/Split Carrier Switch 0: Inter Carrier, 1: Split Carrier	0	
	Audio ATT	7	03H	D0-D6	Audio Out Level Attenuation by 7bit DAC MAX gain=0dB	0	
	Audio EXT	1	02H	D6	AF Direct out/External Audio input signal switch 0: AF amp out, 1: External	0	
	Audio Mute	1	03H	D7	AF Direct out ON/OFF(Mute) switch 0: Sound ON (Non Mute), 1: Mute	0	
	FM Radio	1	0CH	D7	TV / FM Radio switch 0: TV mode, 1: FM Radio mode	0	
	FM Station Level	3	14H	D0-D2	FM Radio station detection level	100	
VIDEO	Video Tone	6	04H	D0-D5	Delay line type Aperture Control	100000	V Latch
	Contrast Control	7	05H	D0-D6	Contrast Control by 7bit DAC	1000000	V Latch
	EXTRGB Contrast Clip	1	05H	D7	Contrast Control Clip Switch when OSD mode 0: Clip ON, 1: Clip OFF	0	V Latch
	Y DL Time Adj	2	06H	D0-D1	Luminance Signal Delay time Adjustment	0	
	Y DL Fine Adj	1	02H	D1	Luminance Signal Delay time Fine pitch Adjustment	0	
	EXT	1	06H	D2	AV Switch Selector 0: TV mode, 1: EXT mode	0	V Latch
	Y/C	1	06H	D4	AV Switch Selector 0: Composit video input, 1: Y/C input mode	0	V Latch
	Y SW LFP	1	14H	D6	Y SW OUT frequency switch 0: FLAT, 1: LFP(fc=700KHz)	0	
	Video Tone Sharp	1	02H	D3	Video Tone Gain (Hi/Normal) switch 0: normal, 1: high(sharp)	0	
	Video Mute	1	02H	D7	Luminance signal Mute ON/OFF switch 0: OUT, 1: Mute	0	
	TRAP Off	1	02H	D4	Chroma Trap ON/OFF switch 0:Chroma Trap ON, 1: Chroma Trap Off	0	
	TRAP Fine Adj	2	12H	D0-D1	Chroma Trap fo Adjustment	00	
	Black Stretch Off	1	06H	D3	Black Stretch function ON/OFF switch 0: ON, 1: OFF	0	
	Black Stretch Charge	2	14H	D4-D5	Charge Time Constant Adjustment for Black Stretch	00	
	Black Stretch Discharge	2	1CH	D6-D7	Discharge Time Constant Adjustment for Black Stretch	00	
	Gamma Control	2	12H	D2-D3	Luminance Gamma Threshold Control 0:Gamma OFF	00	
CHROMA	Tint Control	7	07H	D0-D6	Tint Control by 7bit DAC.	1000000	V Latch
	Color Control	7	08H	D0-D6	Color Saturation Control by 7bit DAC.	1000000	V Latch
	Take Off	1	02H	D0	Chroma BPF/Take Off Switch 0:BPF, 1: Take Off	0	
	C Angle95	1	15H	D1	Chroma Demodulation Angle Switch 0: 103deg, 1: 95deg	0	
	Killer Level	1	15H	D0	Color Killer Sensitivity Threshold Switch 0: 43dB, 1: 45dB	0	
	Force Color	1	15H	D2	Forced Color mode switch 0:OFF, 1: Forced Color	0	
	Force Mono	1	15H	D3	Forced B/W mode 0: OFF, 1: Forced Black&White	0	
Fsc Free	1	15H	D5	Free-running mode of crystal oscillator 0: OFF, 1: Free-running	0		
RGB	Brightness Control	8	0AH	D0-D7	Brightness Control by 8bit DAC	10000000	V Latch
	Drive(R)	7	0BH	D0-D6	R OUT Amplitude Adjustment by 7bit DAC	1000000	
	Drive(B)	7	0CH	D0-D6	B OUT amplitude Adjustment by 7bit DAC	1000000	
	Cut Off(R)	8	0DH	D0-D7	R OUT Pedestal Level Adjustment by 8bit DAC	10000000	
	Cut Off(G)	8	0EH	D0-D7	G OUT Pedestal Level Adjustment by 8bit DAC	10000000	
	Cut Off(B)	8	0FH	D0-D7	B OUT Pedestal Level Adjustment by 8bit DAC	10000000	
	Blue Back	1	08H	D7	Blue Back mode ON/OFF switch 0: OFF, 1: Blue Back	0	
	White Back	1	10H	D7	White Raster mode ON/OFF switch 0: OFF, 1: White Back	0	
	ABCL	1	02H	D2	ABCL ON/OFF switch 0: OFF(ACL), 1: ABCL ON	0	
	ABCL Gain	1	04H	D7	ABCL Gain Low/High switch 0: Low, 1: Hi	0	
	Force S.Killer	1	02H	D5	Forced Spot Killer under Power on condition 1: OFF, 0: Forced S.Killer	0	
	OSD level	1	01H	D7	OSD Level(70%/90%) 0:70% , 1: 90%	0	
Analog OSD	1	15H	D4	OSD Input Digital/Analog switch 0: Digital, 1: Analog	0		
DEF	AFC2 H Phase (H Phase MSB)	5	09H	D4-D7	Horizontal Phase Adjustment by 5bit DAC	1111	
	Ramp Stop	1	10H	D1	pin17 VOUT(Ramp/Pulse)STOP 0:VOUT, 1:STOP	0	
	Service SW	1	13H	D3	0: Vertical output ON/ Contrast Control Normal, 1: Vertical output OFF/Contrast Control Minimum	0	
	H Stop	1	13H	D4	Horizontal output switch 0: H OUT, 1: H STOP	0	
	AFC Gain	1	13H	D5	Horizontal AFC Gain switch 0: Low, 1: High	0	
	AFC2 Gain	1	09H	D1	Horizontal AFC2 Gain switch 0: High, 1: Low	0	
	H VCO Adj	3	10H	D3-D5	H VCO free-running frequency Adjustment	100	
	V Shift	3	13H	D0-D2	V RAMP Sarr timing Adjustment 2Line/Step	0	
	V-Size	6	11H	D0-D5	V RAMP Amplitude Adjustment by 6bit DAC.	100000	
	H-free	1	13H	D7	Horizontal Forced free-running mode switch 0: OFF, 1: Forced Free-running	0	
	V-free	1	0BH	D7	Vertical Forced free-running mode switch 0: OFF, 1: Forced Free-running	0	
	S Slice Down 1	1	10H	D6	Sync Det Slice Level (50%/30%) 0: 50%, 1: 30%	0	
	S Slice Down 2	1	14H	D3	Sync Det Slice Level (50%/40%) 0: 50%, 1: 40%	0	
	Auto Slice Down	1	10H	D0	Sync Det Slice Level switch during video period 0: Slice Level constant, 1: Level down during video	100	
	FBP Vth L	1	14H	D7	Pin6 FBP slice level switch 0:Vth=2V(narrow), 1:Vth=1V(wide)	0	
	1 Window	1	13H	D6	Vertical Sync. Det mode (1 Window/2 Window) 0: 2 Window/Vsyncdet=9µs, 1: 1Window/Vsyncdet=11µs	0	
Monitoring	4	12H	D4-D7	Intelligent Monitor mode selector	0000		
Test1	1	10H	D2	NO USE for CUSTOMER (TEST bit)	100		
Test2	2	16H	D6-D7	NO USE for CUSTOMER (TEST bit)	0		
Test3	2	17H	D6-D7	NO USE for CUSTOMER (TEST bit)	0		
Test4	2	1BH	D6-D7	NO USE for CUSTOMER (TEST bit)	0		

M61206FP

NTSC TV SIGNAL PROCESSOR

READ

KILLERB	1	00H	D7	Killer off for manual mode.
AFT0	1	00H	D3	AFT output
AFT1	1	00H	D2	AFT output
HCOINB	1	00H	D1	Horizontal mute det output. 0: H coincident
FM STDET B	1	00H	D6	Station det for FM Radio mode. 0: Station det.
VCOINB	1	00H	D5	Vertical Sync det output. 0:V coincident
STDET B	1	00H	D4	Station det for TV mode. 0: Station det.

<READ BYTE AFT OUTPUT>

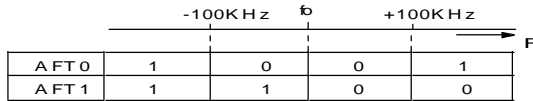

M61206FP

NTSC TV SIGNAL PROCESSOR

Measurement circuit

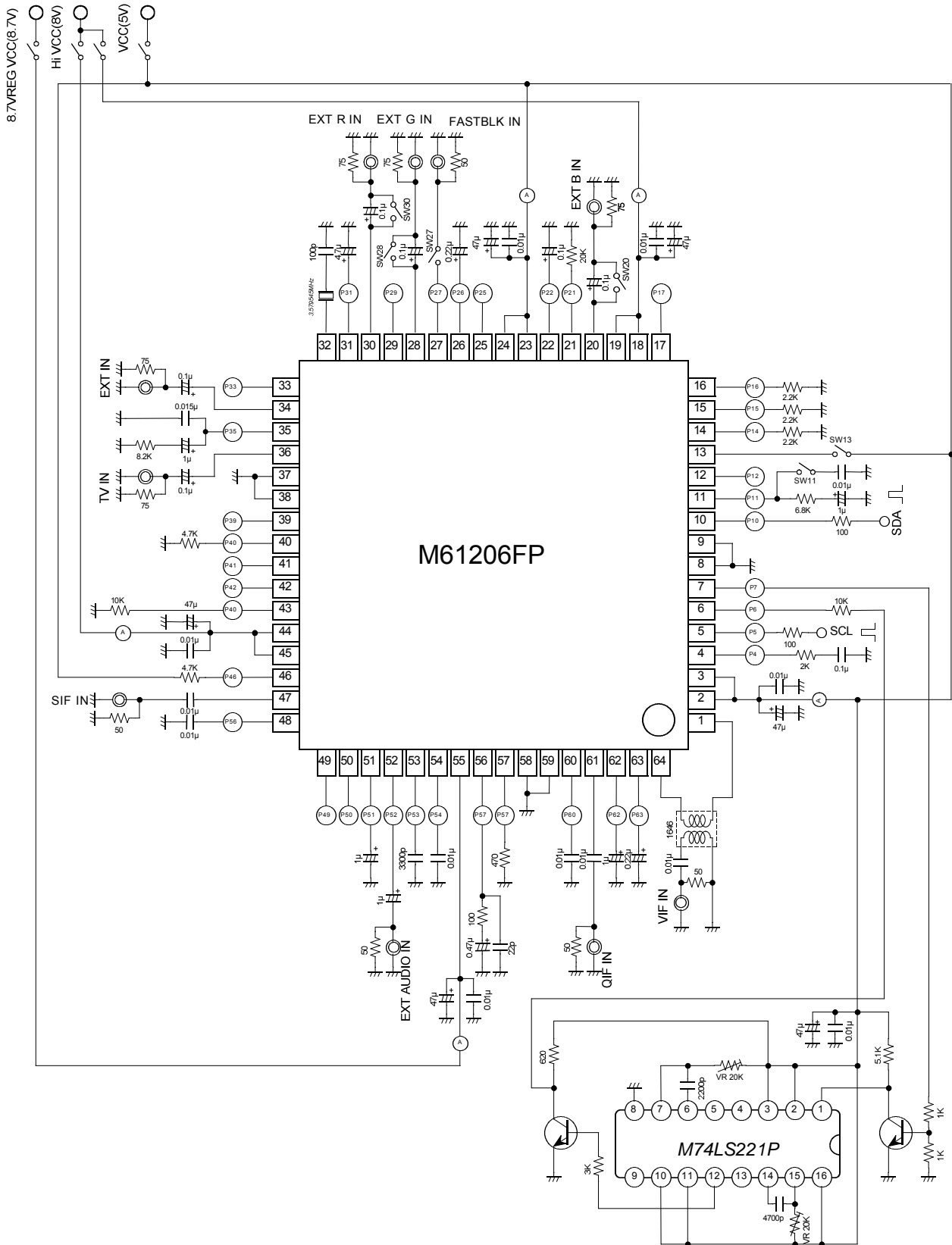

M61206FP

NTSC TV SIGNAL PROCESSOR

INPUT SIGNALS

(1) For VIF/SIF block

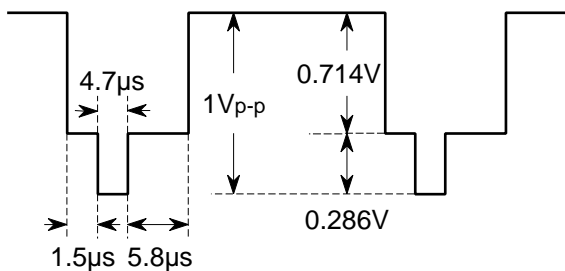
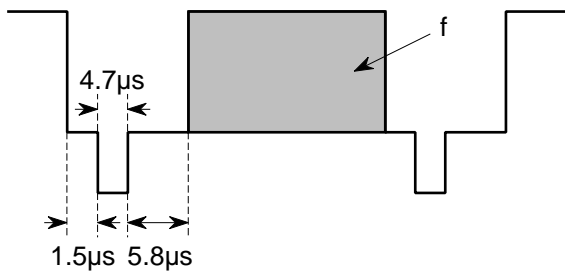
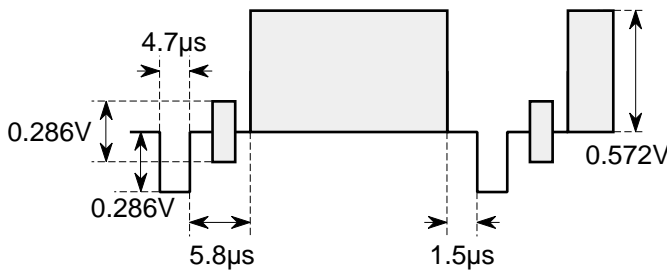
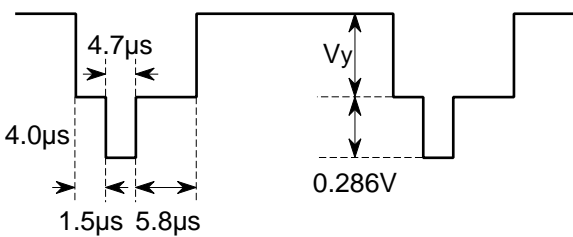

SG No.	Input signal (value at pin terminal is 50Ω)
SG 1	fo=45.75MHz, 90dBμ, fm=20kHz, AM77.8%
SG 2	fo=58.75MHz, 90dBμ, fm=20kHz, AM77.8%
SG 3	fo=45.75MHz, 90dBμ, CW
SG 4	f1=45.75MHz, 90dBμ, CW f2=45.75 ±4.5MHz, 70dBμ, CW
SG 5	fo=45.75MHz, amplitude can be varied, fm=20kHz, AM77.8%
SG 6	fo=45.75MHz, amplitude can be varied, fm=20kHz, AM16%
SG 7	fo=45.75MHz, 80dBμ, fm=20kHz, CW
SG 8	fo=45.75MHz, 110dBμ, fm=20kHz, CW
SG 9	fo=40.75 to 50.75MHz (frequency can be varied), 90dBμ, CW
SG 10	fo=44.75MHz, 90dBμ, CW
SG 11	fo=46.75MHz, 90dBμ, CW
SG 12	fo=53.75 to 63.75MHz(frequency can be varied), 90dBμ, CW
SG 13	f1=45.75MHz, 90dBμ, Red raster signal, AM=87.5% video modulation, f2=4.5MHz, CW, P/S=20dB
SG 14	fo=45.75MHz, Standard 10-step signal, Sync ratio 28.6% AM=87.5% video modulation, Sync tip-Sync tip level 90dBμ
SG 15	fo=45.75MHz, 93dBμ, CW
SG 16	fo=45.75MHz, 73dBμ, CW
SG 17	fo=4.5MHz, 100dBμ, fm=400Hz, FM ±25kHz dev.
SG 18	fo=4.5MHz, 100dBμ, fm=400Hz, AM 30%
SG 19	fo=4.5MHz, 100dBμ, CW
SG 20	fo=400Hz, 500mV _{rms} , CW
SG 21	fo=0.5 to 8.5MHz, 100dBμ, fm=400Hz, FM ±25kHz dev.
SG 22	fo=41.25MHz, amplitude can be varied, CW
SG 23	fo=41.25MHz, 85dBμ, fm=400Hz, FM ±75kHz dev.

(2) VIDEO/CHROMA/RGB/DEF block

SG No.	Input signal (value at pin terminal is 50ohm)
SG. A	<p>NTSC system APL100% standard video signal. The vertical signal should be interlaced at 60Hz.</p> 
SG. B	<p>The amplitude and frequency of Luminance signal can be varied by signal SG. A. The typical amplitude is 0.714mV_{p-p}. The frequency of Luminance, (f) as stated in test.</p> 
SG. C	<p>NTSC system standard monochrome video signal. The vertical signal should be interlaced at 60Hz.</p> 
SG. D	<p>NTSC system video signal. APL can be varied. The vertical signal should be interlaced at 60Hz.</p> 

M61206FP

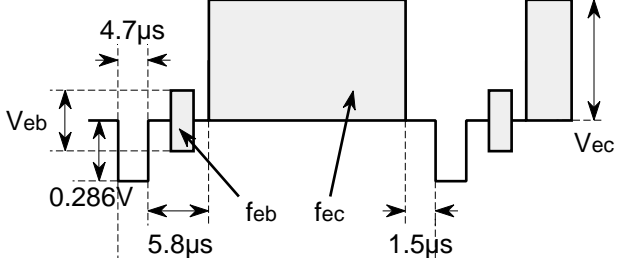
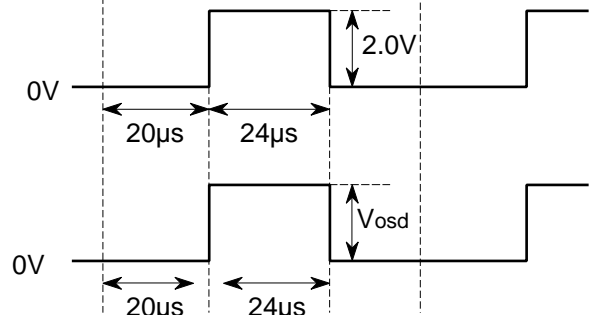
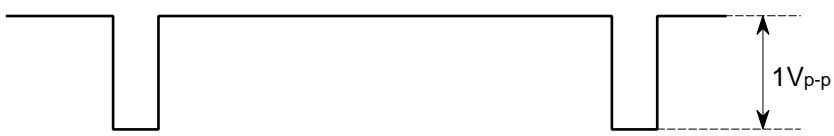
NTSC TV SIGNAL PROCESSOR

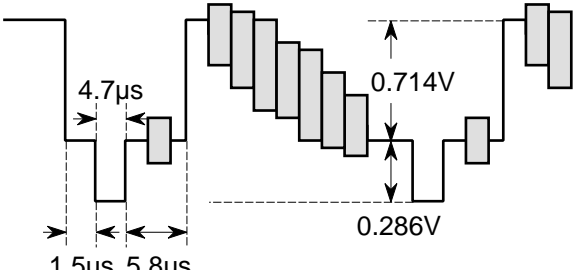
SG No.	Input signal (value at pin terminal is 50ohm)
SG. E	<p>NTSC system mono-chroma video signal. The amplitude and frequency of burst part and chroma part can be varied. The vertical signal should be interlaced at 60Hz.</p> <p>(typical condition: $V_{eb}=0.286V$, $V_{ec}=0.572V$ $f_{eb}=f_{ec}=3.579545MHz$)</p> 
SG. F	<p>Fast blanking signal. It should be synchronized with input video signal.</p> <p>External RGB (OSD) signals. They should be synchronized with input video signal and fast blanking signal.</p> 
SG. G	<p>NTSC system rainbow color bar video signal. The vertical signal should be interlaced at 60Hz.</p>
SG. H	<p>Duty cycle 90%, frequency can be varied, level can be varied (typ. $1V_{p-p}$)</p> 
SG. I	<p>Duty cycle can be varied (typ. 95%), frequency can be varied, level can be varied (typ. $1V_{p-p}$)</p> 
SG. J	<p>NTSC system standard color bar video signal. The vertical signal should be interlaced at 60Hz.</p> 
SG. K	<p>NTSC system standard 8-steps signal. The vertical signal should be interlaced at 60Hz.</p>

Setup instruction for evaluation PCB**(1) Horizontal blanking pulse adjustment**

The timing and pulse width of the horizontal blanking pulse should be as shown in the following figure by adjusting the variable resistor of the single shot multi vibrator.

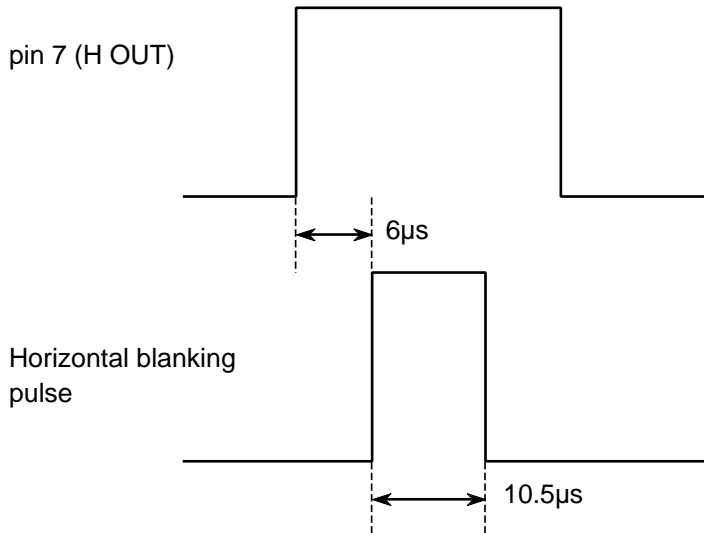

The variable resistor at pin 15 of TTL IC 'M74LS221P' is used to fix the timing at $8\mu\text{s}$ and that at pin 7 is used to fix the pulse width at $12\mu\text{s}$.

(2) VIF VCO adjustment

Before measurement of M61206FP, VIF VCO must be adjusted by the following procedure.

- (1) Input I²C bus data of VIF Freq (01H D6), according as IF frequency.
(45.75MHz : 0, 58.75MHz : 1)
- (2) Input I²C bus data of VIF Defeat ON (07H D7 = 1).
- (3) Set the DC voltage at pin 60 (AFT OUT) to 2.5V by adjusting I²C bus data of VCO control (01H D0-D5).
- (4) Input I²C bus data of VIF Defeat OFF (07H D7 = 0).

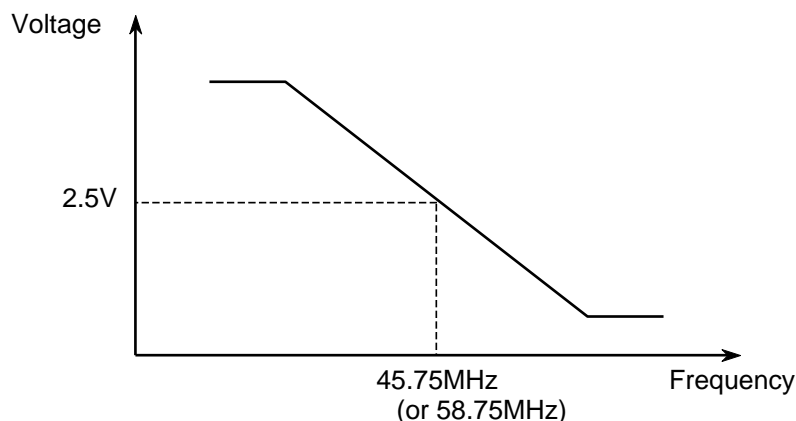
**(3) H VCO adjustment**

Before measurement of M61206FP, H VCO must be adjusted by the following procedure.

- (a) Set the frequency at pin 7 (H OUT) to about 15.734kHz by adjusting I²C bus data of H VCO control (10H D3-D5).

Electrical characteristics (Ta=25°C)

Symbol	Parameter	Input signal		Test point	Limits			Unit	Remarks
		Pins	SG		Min.	Typ.	Max.		
ICC	Standard conditions								pin13=5V, pin27=0V
ICC5V	5V current (Pins 2,3,23 and 24)	-	-	2,3,23,24	67	86	96	mA	VIF/SIF/VIDEO/Chroma supply
ICC23	Pins 2 and 3 supply current	-	-	2,3	-	41	-	mA	Reference data VIF/SIF supply
ICC2324	Pins 23 and 24 supply current	-	-	23,24	-	45	-	mA	Reference data VIDEO/Chroma supply
ICC8V	8V current	-	-	18,19,44,45	24	33	39	mA	Start up/Deflection/RGB Drive 8V supply
ICC1819	Pins 18 and 19 supply current	-	-	18,19	-	20	-	mA	Reference data Start up supply Deflection
ICC4445	Pins 44 and 45 supply current	-	-	44,45	-	13	-	mA	Reference data RGB Drive 8V supply
ICC55	Pin 55 supply current	-	-	55	6	7	8	mA	8.7 VREG supply

Power	Standard conditions of Power supply parameter								pin13=5V, pin27=0V
Vth13	Power ON Control threshold voltage	-	-	13	2.6	3	3.4	V	
V33H	8.7 VREG output voltage 1	-	-	33	8.3	8.7	8.8	V	pin13=5V
V33L	8.7 VREG output voltage 2	-	-	33	-	0	0.3	V	pin13=0V
V39	5.7 VREG output voltage 1	-	-	39	5.45	5.6	5.85	V	pin13=5V
V41H1	MCU 5.7 VREG output voltage 1	-	-	41	5.35	5.6	5.85	V	pin13=5V
V41H2	MCU 5.7 VREG output voltage 2	-	-	41	5.35	5.6	5.85	V	pin13=0V
V46H	SW REG Control output voltage 1	-	-	46	0	0.3	1	V	pin13=5V
V46L	SW REG Control output voltage 2	-	-	46	4.5	5	-	V	pin13=0V
Reset	Standard conditions of Reset parameter								pin13=5V
V42H	Reset output high voltage	-	-	42	4.5	5	5.5	V	
V42L	Reset output low voltage	-	-	42	-	0	0.5	V	
TH42	Reset threshold voltage	-	-	41	4	4.2	4.4	V	

IIC	Standard conditions of IIC parameter	-	-	-	-	-	-	-	
IACK	ACK current	-	-		-	1	-	mA	
VIL	SCL/SDA input low voltage	-	-	5,10	0.0	0.75	1.5	V	

NTSC TV SIGNAL PROCESSOR

Symbol	SUB ADDRESS																									
	00H	01H	02H	03H	04H	05H	06H	07H	08H	09H	0AH	0BH	0CH	0DH	0EH	0FH	10H	11H	12H	13H	14H	15H	16H	17H	1BH	1CH
ICC	40	20	00	00	20	40	88	40	40	F0	80	40	40	80	80	80	24	20	00	10	00	00	00	00	00	00
ICC5V																										
ICC23																										
ICC2324																										
ICC8V																										
ICC1819																										
ICC4445																										
ICC55																										

Power	40	adj	00	00	20	40	88	40	40	F0	80	40	40	80	80	80	24	20	00	10	00	00	00	00	00	
Vth13																										
V33H																										
V33L																										
V39																										
V41H1																										
V41H2																										
V46H																										
V46L																										
Reset	40	adj	00	00	20	40	88	40	40	F0	80	40	40	80	80	80	24	20	00	10	00	00	00	00	00	
V42H																										
V42L																										
TH42																										

IIC	40	adj	00	00	20	40	88	40	40	F0	80	40	40	80	80	80	24	20	00	10	00	00	00	00	00	
IACK																										
VIL																										

NTSC TV SIGNAL PROCESSOR

Symbol	Parameter	Input signal		Test point	Limits			Unit	Remarks
		Pins	SG		Min.	Typ.	Max.		
VIH	SCL/SDA input high voltage	-	-	5,10	3.5	4.25	5.0	V	
FsCL	Clock frequency	-	-	5	-	-	100	kHz	
VIF	Standard conditions of IF parameter								pin13=5V, pin27=0V
Vdc	Video detector output DC voltage	-	-	57	2.2	2.7	3.2	V	pin63=0V
Vo4575	Video detector output (45.75MHz)	1,64	SG1	57	0.7	1.0	1.4	Vpp	
Vo5875	Video detector output (58.75MHz)	1,64	SG2	57	0.7	1.0	1.4	Vpp	
P/N	Video S/N	1,64	SG3	57	43	50	-	dB	
Vf	Video frequency characteristics	1,64	SG4	57	4	5.4	-	MHz	
Vin min	Input sensitivity	1,64	SG5	57	-	45	50	dBu	
Vin max	Maximum permissible input	1,64	SG6	57	100	108	-	dBu	
GR	AGC control range	-	-	-	50	-	-	dB	Vo max - Vo min
V63H	Maximum IF AGC voltage	-	-	63	3.8	4.3	4.8	V	
V63T	IF AGC voltage (80dBu)	1,64	SG7	63	2.3	2.8	3.3	V	
V63L	Minimum IF AGC voltage	1,64	SG8	63	1.7	2.2	2.7	V	
Vdefeat	VIF DEFEAT function	1,64	SG1	57	0	0.1	0.2	Vpp	
uAFT	AFT detector sensitivity	1,64	SG9	60	7	10	13	mV/kHz	
V60H	Maximum AFT voltage	1,64	SG10	60	4.2	4.7	-	V	
V60L	Minimum AFT voltage	1,64	SG11	60	-	0.3	0.8	V	
V60D	AFT DEFEAT voltage	-	-	60	2.0	2.5	3.0	V	
VCU45	Capture range (45.75MHz upper)	1,64	SG9	57	1.5	2.2	-	MHz	Center frequency=45.75MHz
VCL45	Capture range (45.75MHz lower)	1,64	SG9	57	-	-1.8	-1.1	MHz	Center frequency=45.75MHz
VCT45	Capture range (45.75MHz total)	-	-	57	2.6	4.0	-	MHz	VCU45-VCL45
VCU58	Capture range (58.75MHz upper)	1,64	SG12	57	1.5	2.2	-	MHz	Center frequency=58.75MHz
VCL58	Capture range (58.75MHz lower)	1,64	SG12	57	-	-1.8	-1.1	MHz	Center frequency=58.75MHz
VCT58	Capture range (58.75MHz total)	-	-	57	2.6	4.0	-	MHz	VCU58-VCL58
IM	Intermodulation	1,64	SG13	57	-	42	-	dB	Reference data
DG	Differential gain	1,64	SG14	57	-	3	-	%	Reference data
DP	Differential phase	1,64	SG14	57	-	3	-	deg	Reference data
V62H	Maximum RF AGC voltage	1,64	SG15	62	4.3	4.8	-	V	

NTSC TV SIGNAL PROCESSOR

Symbol	SUB ADDRESS																									
	00H	01H	02H	03H	04H	05H	06H	07H	08H	09H	0AH	0BH	0CH	0DH	0EH	0FH	10H	11H	12H	13H	14H	15H	16H	17H	1BH	1CH
VIH																										
FsCL																										
VIF	40	adj	00	00	20	40	88	40	40	F0	80	40	40	80	80	80	24	20	00	10	00	00	00	00	00	
Vdc																										
Vo4575																										
Vo5875		+40																								
P/N																										
Vf																										
Vin min																										
Vin max																										
GR																										
V63H																										
V63T																										
V63L																										
Vdefeat																										
uAFT																										
V60H																										
V60L																										
V60D																										
VCU45																										
VCL45																										
VCT45																										
VCU58																										
VCL58																										
VCT58																										
IM																										
DG																										
DP																										
V62H																										

Symbol	Parameter	Input signal		Test point	Limits			Unit	Remarks
		Pins	SG		Min.	Typ.	Max.		
V62L	Minimum RF AGC voltage	1,64	SG16	62	-	0.2	0.7	V	
DLPH	Maximum RF AGC delay point	1,64	SG5	62	95	108	-	dBu	
DLPL	Minimum RF AGC delay point	1,64	SG5	62	-	58	71	dBu	

Symbol	SUB ADDRESS																									
	00H	01H	02H	03H	04H	05H	06H	07H	08H	09H	0AH	0BH	0CH	0DH	0EH	0FH	10H	11H	12H	13H	14H	15H	16H	17H	1BH	1CH
V62L																										
DLPH	00																									
DLPL	7F																									

Symbol	Parameter	Input signal		Test point	Limits			Unit	Remarks
		Pins	SG		Min.	Typ.	Max.		
DLP	RF AGC delay point adjustment range	-	-	-	33	43	-	dBu	DLPH-DLPL
SPN	Sync ratio	1,64	SG14	57	25	28	33	%	
SIF	Standard conditions of SIF parameter								pin13=5V, pin27=0V
VAF	AF direct output DC voltage	-	-	53	2.2	3.0	3.8	V	
VoAF	AF direct output voltage	47	SG17	53	330	590	850	mV _{rms}	
THD AF	AF output distortion	47	SG17	53	-	0.5	3	%	
LIM	Input limiting sensitivity	47	SG17	53	-	46	55	dBu	
AMR	AM rejection	47	SG18	53	48	54	-	dB	
AFSN	AF S/N	47	SG19	50	49	55	-	dB	
GEAu	EXT Audio gain	52	SG20	50	-4.1	-2.1	-0.1	dB	
SCFU	SIF capture frequency (upper)	47	SG21	53	5.5	7.5	-	MHz	Vary frequency of input signal.
SCFL	SIF capture frequency (lower)	47	SG21	53	-	3	4.0	MHz	Vary frequency of input signal.
VOL-max	Audio output maximum amplitude	47	SG17	50	350	620	890	mV _{rms}	
VOL-min	Audio ATT maximum attenuation	47	SG17	50	-	-80	-69	dB	
QIF/FM	Standard conditions of QIF parameter								pin13=5V, pin27=0V
QIF1	QIF detector output 1	61	SG22	49	91	97	103	dBu	vi=90dBu
QIF2	QIF detector output 2	61	SG22	49	91	97	103	dBu	vi=75dBu
FM-VoAF	FM mode AF direct output voltage	61	SG23	53	330	590	850	mV _{rms}	
FM-S/N	FM mode S/N	61	SG22	53	38	42	-	dB	
FM-OUT	FM mode video detector output	61	SG23	57	2.2	2.7	3.2	V	
FM-RFAGC1	FM mode RF AGC delay 1	61	SG23	62	5	23	41	data	vi=100dBu

Symbol	SUB ADDRESS																									
	00H	01H	02H	03H	04H	05H	06H	07H	08H	09H	0AH	0BH	0CH	0DH	0EH	0FH	10H	11H	12H	13H	14H	15H	16H	17H	1BH	1CH
DLP	00-7F																									
SPN																										
SIF	40	adj	00	00	20	40	88	40	40	F0	80	40	40	80	80	80	24	20	00	10	00	00	00	00	00	
VAF				80																						
VoAF																										
THD AF																										
LIM																										
AMR																										
AFSN				7F																						
GEAu			40	7F																						
SCFU																										
SCFL																										
VOL-max				7F																						
VOL-min																										
QIF/FM	40	adj	00	00	20	40	88	40	40	F0	80	40	40	80	80	80	24	20	00	10	00	00	00	00	00	
QIF1	C0											C0														
QIF2	C0											C0														
FM-VoAF	C0											C0														
FM-S/N	C0											C0														
FM-OUT	C0											C0														
FM-RFAGC1	C0											C0														

Symbol	Parameter	Input signal		Test point	Limits			Unit	Remarks
		Pins	SG		Min.	Typ.	Max.		
FM-RFAGC2	FM mode RF AGC delay 2	61	SG23	62	73	84	95	data	vi=85dBu
FM-RFAGC3	FM mode RF AGC delay 3	61	SG23	62	100	107	114	data	vi=75dBu
VIDEO	Standard conditions of video character	-	-	-	-	-	-	-	pin13=5V, pin27=0V
2AGTV	Video SW output level (TV input)	36	SG.A	40	1.6	2.0	2.6	V _{pp}	
2AGEV	Video SW output level (External input)	34	SG.A	40	1.6	2.0	2.6	V _{pp}	
Ymax	Video maximum output	34	SG.A	14,15,16	2.9	4.2	5.6	V	
GY	Video gain	34	SG.A	14,15,16	12	15	18	dB	
FBY	Video frequency characteristics	34	SG.B	14,15,16	-4	-1	-	dB	f=5MHz, C-trap : OFF
CRF	Chroma trap attenuation	34	SG.C	14,15,16	-	-	-18	dB	
TRF	Chroma trap maximum attenuation	34	SG.C	14,15,16	-	-	-20	dB	After Trap fine adj. is adjusted.
YDL1	Y delay time 1	34	SG.A	14,15,16	190	260	330	nS	
YDL2	Y delay time 2	34	SG.A	14,15,16	120	200	280	nS	YDL2=measure - YDL1
YDL3	Y delay time 3	34	SG.A	14,15,16	120	200	280	nS	YDL3=measure - YDL2
YDL4	Y delay time 4	34	SG.A	14,15,16	120	200	280	nS	YDL4=measure - YDL3
GTnor	Video tone control characteristic 1	34	SG.B	14,15,16	1.0	1.4	1.8	V	f=2.5MHz
GTmax	Video tone control characteristic 2	34	SG.B	14,15,16	7	10	14	dB	f=2.5MHz
GTmin	Video tone control characteristic 3	34	SG.B	14,15,16	-6	-2	2	dB	f=2.5MHz
GT2M	Video tone control characteristic 4	34	SG.B	14,15,16	-1	2	5	dB	f=2MHz
GT5M	Video tone control characteristic 5	34	SG.B	14,15,16	-9	-5	-1	dB	f=5MHz
BLS	Black stretch characteristic	34	SG.K	14,15,16	0.01	0.03	0.05	V	
VMF	Video mute function	34	SG.A	14,15,16	-	-45	-35	dB	

Symbol	SUB ADDRESS																									
	00H	01H	02H	03H	04H	05H	06H	07H	08H	09H	0AH	0BH	0CH	0DH	0EH	0FH	10H	11H	12H	13H	14H	15H	16H	17H	1BH	1CH
FM-RFAGC2	C0												C0													
FM-RFAGC3	C0												C0													
VIDEO	40	adj	00	00	20	40	88	40	40	F0	80	40	40	80	80	80	24	20	00	10	00	00	00	00	00	
2AGTV																										
2AGEV							8C																			
Ymax						7F	8C		00																	
GY						7F	8C		00																	
FBY			10			7F	8C		00																	
CRF							8C		00											02						
TRF							8C		00											00-03						
YDL1							8C		00																	
YDL2							8D		00																	
YDL3							8E		00																	
YDL4							8F		00																	
GTnor							8C		00																	
GTmax					3F		8C		00																	
GTmin					00		8C		00																	
GT2M							8C		00																	
GT5M							8C		00																	
BLS						adj	8C		00		adj										30					C0
VMF			80			7F	8C		00																	

Symbol	Parameter	Input signal		Test point	Limits			Unit	Remarks
		Pins	SG		Min.	Typ.	Max.		
CHROM A	Standard condition of chroma parameter	-	-	-	-	-	-	-	pin13=5V, pin27=0V
CnorR	Chroma standard output (R-Y)	34	SG.C	62	390	560	790	mV	
CnorB	Chroma standard output (B-Y)	34	SG.C	62	640	920	1290	mV	
ACC1	ACC characteristic 1	34	SG.E	62	-3	0	3	dB	V _{eb} , V _{ec} : +6dB of typical input level
ACC2	ACC characteristic 2	34	SG.E	62	-4.5	0	1.5	dB	V _{eb} , V _{ec} : -20dB of typical input level
OV	Chroma overload characteristic	34	SG.E	62	-3	2	5	dB	V _{ec} = 800mV
VikN	Killer operation input level	34	SG.E	62	-	-43	-35	dB	V _{eb} , V _{ec} : variable
KillP	Color residual at Killer on	34	SG.E	62	-	-45	-30	dB	V _{eb} = 0mV
APCU	APC pull-in range (upper)	34	SG.E	62	-	-600	-300	Hz	f _{eb} =f _{ec} : variable
APCL	APC pull-in range (lower)	34	SG.E	62	300	600	-	Hz	f _{eb} =f _{ec} : variable
R/BN	Demodulated output ratio	34	SG.E	62	0.40	0.57	0.80	-	f _{ec} =f _{eb} +50kHz
R-YN1	Demodulation phase angle 1	34	SG.E	62	86	103	120	deg	f _{ec} =f _{eb} +50kHz
R-YN2	Demodulation phase angle 2	34	SG.E	62	78	95	112	deg	f _{ec} =f _{eb} +50kHz
TC1	TINT control characteristic 1	34	SG.E	62	30	45	60	deg	f _{eb} =f _{ec} +50kHz
TC2	TINT control characteristic 2	34	SG.E	62	30	45	60	deg	f _{eb} =f _{ec} +50kHz
Ffsc	fsc output frequency	34	SG.C	25	3.5793	3.5796	3.5799	MHz	
Vfsc	fsc output amplitude	34	SG.C	25	250	500	800	mV _{pp}	
Ffscfree	fsc output frequency at fsc free mode	34	SG.C	25	3.5790	3.5795	3.5810	MHz	
Vfsc	fsc output amplitude at fsc free mode	34	SG.C	25	250	500	800	mV _{pp}	

Symbol	SUB ADDRESS																									
	00H	01H	02H	03H	04H	05H	06H	07H	08H	09H	0AH	0BH	0CH	0DH	0EH	0FH	10H	11H	12H	13H	14H	15H	16H	17H	1BH	1CH
CHROM A	40	adj	00	00	20	40	88	40	40	F0	80	40	40	80	80	80	24	20	00	10	00	00	00	00	00	00
CnorR							8C																C0	40		
CnorB							8C																80	40		
ACC1							8C																80	40		
ACC2							8C																80	40		
OV							8C																80	40		
VikN							8C																80	40		
KIIP							8C																80	40		
APCU							8C																80	40		
APCL							8C																80	40		
R/BN							8C																C0/ 80	40		
R-YN1							8C																C0/ 80	40		
R-YN2							8C															02	C0/ 80	40		
TC1							8C	7F															80	40		
TC2							8C	00															80	40		
Fsc							8C																			
Vfsc							8C																			
Fscfree							8C																20			
Vfsc							8C																20			

Symbol	Parameter	Input signal		Test point	Limits			Unit	Remarks
		Pins	SG		Min.	Typ.	Max.		
RGB	Standard condition of RGB parameter	-	-	-	-	-	-	-	pin13=5V, pin27=0V
VBLK	Output Blanking voltage	34	SG.A	14,15,16	0	0.1	0.3	V	
GYtyp	Contrast control characteristic 1	34	SG.B	14,15,16	1.6	2.1	2.7	V _{pp}	f=100kHz
GYmin	Contrast control characteristic 2	34	SG.B	14,15,16	-	200	300	mV	f=100kHz
GYEnor	Contrast control characteristic 3	34	SG.A	14,15,16	1.6	2.1	2.7	V	pin31=2.9V
GYEmin	Contrast control characteristic 4	34	SG.A	14,15,16	-	100	200	mV	pin31=0.0V
GYEclip	Contrast control characteristic 5	28,30	SG.F	14,15,16	0.50	0.65	0.80	V	pin27=2.5V
Lum nor	Brightness control characteristic 1	34	SG.D	14,15,16	1.7	2.1	2.5	V	V _y = 0.0V
Lum max	Brightness control characteristic 2	34	SG.D	14,15,16	0.6	0.9	-	V	V _y = 0.0V
Lum min	Brightness control characteristic 3	34	SG.D	14,15,16	-	-0.8	-0.5	V	V _y = 0.0V
D(R)1	R Drive control characteristic 1	34	SG.A	14	2.0	4.0	6.0	dB	
D(B)1	B Drive control characteristic 1	34	SG.A	14	2.0	4.0	6.0	dB	
D(R)2	R Drive control characteristic 2	34	SG.A	16	-5.0	-3.0	-1.0	dB	
D(B)2	B Drive control characteristic 2	34	SG.A	16	-5.0	-3.0	-1.0	dB	
EXD1(R)	Digital OSD (R) I/O characteristic1	20,27,34	SG.F, SG.A	14	1.0	1.5	2.0	V _{pp}	V _{osd} = 1.0V, SW30=ON
EXD1(G)	Digital OSD (G) I/O characteristic1	27,28,34	SG.F, SG.A	15	1.0	1.5	2.0	V _{pp}	V _{osd} = 1.0V, SW28=ON
EXD1(B)	Digital OSD (B) I/O characteristic1	27,30,34	SG.F, SG.A	16	1.0	1.5	2.0	V _{pp}	V _{osd} = 1.0V, SW20=ON
EXD2(R)	Digital OSD (R) I/O characteristic2	20,27,34	SG.F, SG.A	14	200	300	400	mV	V _{osd} = 1.0V, SW30=ON EXD2(R)=measure - EXD1(R)
EXD2(G)	Digital OSD (G) I/O characteristic2	27,28,34	SG.F, SG.A	15	200	300	400	mV	V _{osd} = 1.0V, SW28=ON EXD2(G)=measure - EXD1(G)
EXD2(B)	Digital OSD (B) I/O characteristic2	27,30,34	SG.F, SG.A	16	200	300	400	mV	V _{osd} = 1.0V, SW20=ON EXD2(B)=measure - EXD1(B)
EXD1(R-G)	Digital OSD level difference R and G	-	-	-	-350	0	350	mV	
EXD1(G-B)	Digital OSD level difference G and B	-	-	-	-350	0	350	mV	
EXD1(B-R)	Digital OSD level difference B and R	-	-	-	-350	0	350	mV	
EXA(R)	Analog OSD (R) I/O characteristic	20,27,34	SG.F, SG.A	14	1.2	2.1	3.0	V _{pp}	V _{osd} = 0.7V
EXA(G)	Analog OSD (G) I/O characteristic	27,28,34	SG.F, SG.A	15	1.2	2.1	3.0	V _{pp}	V _{osd} = 0.7V
EXA(B)	Analog OSD (B) I/O characteristic	27,30,34	SG.F, SG.A	16	1.2	2.1	3.0	V _{pp}	V _{osd} = 0.7V
EXA(R-G)	Analog OSD level difference R and G	-	-	-	-350	0	350	mV	
EXA(G-B)	Analog OSD level difference G and B	-	-	-	-350	0	350	mV	
EXA(B-R)	Analog OSD level difference B and R	-	-	-	-350	0	350	mV	

NTSC TV SIGNAL PROCESSOR

Symbol	SUB ADDRESS																									
	00H	01H	02H	03H	04H	05H	06H	07H	08H	09H	0AH	0BH	0CH	0DH	0EH	0FH	10H	11H	12H	13H	14H	15H	16H	17H	1BH	1CH
RGB	40	adj	00	00	20	40	88	40	40	F0	80	40	40	80	80	80	24	20	00	10	00	00	00	00	00	00
VBLK							8C		00																	
GYtyp							8C		00																	
GYmin						00	8C		00																	
GYEnor							8C		00																	
GYEmin							8C		00																	
GYEclip						00	8C		00																	
Lum nor							8C		00																	
Lum max							8C		00		FF															
Lum min							8C		00		00															
D(R)1							8C		00		00	7F														
D(B)1							8C		00		00		7F													
D(R)2							8C		00		00	00														
D(B)2							8C		00		00		00													
EXD1(R)		00					8C		00																	
EXD1(G)		00					8C		00																	
EXD1(B)		00					8C		00																	
EXD2(R)		80					8C		00																	
EXD2(G)		80					8C		00																	
EXD2(B)		80					8C		00																	
EXD1(R-G)							8C																			
EXD1(G-B)							8C																			
EXD1(B-R)							8C																			
EXA(R)						40	8C		00														10			
EXA(G)						40	8C		00														10			
EXA(B)						40	8C		00														10			
EXA(R-G)							8C																10			
EXA(G-B)							8C																10			
EXA(B-R)							8C																10			

Symbol	Parameter	Input signal		Test point	Limits			Unit	Remarks
		Pins	SG		Min.	Typ.	Max.		
OFRG	Offset voltage between R and G	34	SG.D	14,15	-100	0	100	mV	$V_y = 0.0V$
OFBG	Offset voltage between B and G	34	SG.D	15,16	-100	0	100	mV	$V_y = 0.0V$
C(R)1	R Cut off control characteristic 1	34	SG.D	14	2.6	2.9	3.2	V	$V_y = 0.0V$
C(G)1	G Cut off control characteristic 1	34	SG.D	15	2.6	2.9	3.2	V	$V_y = 0.0V$
C(B)1	B Cut off control characteristic 1	34	SG.D	16	2.6	2.9	3.2	V	$V_y = 0.0V$
C(R)2	R Cut off control characteristic 2	34	SG.D	14	1.1	1.4	1.7	V	$V_y = 0.0V$
C(G)2	G Cut off control characteristic 2	34	SG.D	15	1.1	1.4	1.7	V	$V_y = 0.0V$
C(B)2	B Cut off control characteristic 2	34	SG.D	16	1.1	1.4	1.7	V	$V_y = 0.0V$
Ccon 1	Color control characteristic 1	34	SG.C	15	2	5	8	dB	
Ccon 2	Color control characteristic 2	34	SG.C	15	-	-15	-10	dB	
Ccon 3	Color control characteristic 3	34	SG.C	15	-	-40	-35	dB	
MTXRB	Matrix ratio R/B	34	SG.G	14,16	0.81	0.98	1.08	-	
MTXGB	Matrix ratio G/B	34	SG.G	15,16	0.29	0.37	0.45	-	
DOSD1	Digital OSD speed characteristic 1	27,30,34	SG.F, SG.A	14	-	0.05	0.13	us	$V_{osd} = 1.0V, SW30=ON$
DOSD2	Digital OSD speed characteristic 2	27,30,34	SG.F, SG.A	14	-	0.05	0.13	us	$V_{osd} = 1.0V, SW30=ON$
AOSD1	Analog OSD speed characteristic 1	27,30,34	SG.F, SG.A	14	-	0.05	0.13	us	$V_{osd} = 1.0V$
AOSD2	Analog OSD speed characteristic 2	27,30,34	SG.F, SG.A	14	-	0.05	0.13	us	$V_{osd} = 1.0V$
BB(R)	Blue back function (R)	34	SG.A	14	1.7	2.1	2.5	V	
BB(G)	Blue back function (G)	34	SG.A	15	1.7	2.1	2.5	V	
BB(B)	Blue back function (B)	34	SG.A	16	2.7	3.7	4.7	V	
WB	White raster function	34	SG.A	14,15,16	2.7	3.7	4.7	V	

Symbol	SUB ADDRESS																									
	00H	01H	02H	03H	04H	05H	06H	07H	08H	09H	0AH	0BH	0CH	0DH	0EH	0FH	10H	11H	12H	13H	14H	15H	16H	17H	1BH	1CH
OFRG						8C		00																		
OFBG						8C		00																		
C(R)1						8C		00						FF												
C(G)1						8C		00							FF											
C(B)1						8C		00								FF										
C(R)2						8C		00						00												
C(G)2						8C		00							00											
C(B)2						8C		00								00										
Ccon 1			80			8C		7F																		
Ccon 2			80			8C		01																		
Ccon 3			80			8C		00																		
MTXRB						8C																				
MTXGB						8C																				
DOSD1						7F	8C																			
DOSD2						7F	8C																			
AOSD1						7F	8C																	10		
AOSD2						7F	8C																	10		
BB(R)						8C		80																		
BB(G)						8C		80																		
BB(B)						8C		80																		
WB						8C											A0									

NTSC TV SIGNAL PROCESSOR

Symbol	Parameter	Input signal		Test point	Limits			Unit	Remarks
		Pins	SG		Min.	Typ.	Max.		
DEF	Standard condition of deflection parameter	-	-	-	-	-	-	-	pin13=5V, pin27=0V
fH1	Horizontal free-running frequency 1	-	-	7	15.3	15.7	16.1	kHz	
fH2	Horizontal free-running frequency 2	-	-	7	14.7	15.1	15.5	kHz	
fH3	Horizontal free-running frequency 3	-	-	7	15.8	16.2	16.6	kHz	
Hfree	Forced horizontal free-running function	34	SG.A	7	15.3	15.7	16.1	kHz	
FPHU	Horizontal pull-in range (upper)	34	SG.H	7	250	500	-	Hz	Vary frequency of input signal.
FPHL	Horizontal pull-in range (lower)	34	SG.H	7	-	-500	-250	Hz	Vary frequency of input signal.
HPT1	Horizontal pulse timing 1	34	SG.A	7	9.5	11.0	12.5	us	
HPT2	Horizontal pulse timing 2	34	SG.A	7	4.5	6.0	7.5	us	
HPTW	Horizontal pulse width	-	-	7	21	25	29	us	
VH	Horizontal pulse amplitude	-	-	7	4.7	5.4	-	V	
HSTO	Horizontal pulse stop function	-	-	7	-	0.0	0.5	V	
AFCG	AFC gain operation	34	SG.A	11	2.0	3.0	10.0	dB	
fV	Vertical free-running frequency	-	-	17	55	60	65	Hz	
Vfree	Forced Vertical free-run function	34	SG.A	17	55	60	65	Hz	
SVC	Service mode function	-	-	17	4.2	4.7	5.2	V	
FPVU	Vertical pull-in frequency (upper)	34	SG.H	17	63	67	-	Hz	Vary frequency of input signal.
FPVL	Vertical pull-in frequency (lower)	34	SG.H	17	-	55	57	Hz	Vary frequency of input signal.
VRsi 1	Vertical ramp size	34	SG.A	17	1.6	2.0	2.4	Vpp	
VRsc 1	Vertical ramp size control range 1	34	SG.A	17	2.0	2.4	2.8	Vpp	
VRsc 2	Vertical ramp size control range 2	34	SG.A	17	0.8	1.2	1.6	Vpp	
VRpo 1	Vertical ramp position control range 1	34	SG.A	17	18	38	58	us	
VRpo 2	Vertical ramp position control range 2	34	SG.A	17	840	860	880	us	(Measured value) - (Vrpo 1)
VW	Vertical pulse width	34	SG.A	29	0.35	0.53	0.65	ms	
VBLKW	Vertical blanking width	34	SG.A	14,15,16	1.32	1.47	1.62	ms	
WVSS	Minimum vertical sync detection width	34	SG.I	17	13	-	-	us	Vary duty cycle of input signal.

NTSC TV SIGNAL PROCESSOR

Symbol	SUB ADDRESS																									
	00H	01H	02H	03H	04H	05H	06H	07H	08H	09H	0AH	0BH	0CH	0DH	0EH	0FH	10H	11H	12H	13H	14H	15H	16H	17H	1BH	1CH
DEF	40	adj	00	00	20	40	88	40	40	F0	80	40	40	80	80	80	24	20	00	10	00	00	00	00	00	00
fH1																										
fH2																	04									
fH3																34										
Hfree							8C													90						
FPHU							8C																			
FPHL							8C																			
HPT1							8C			08										30						
HPT2							8C			F8										30						
HPTW																										
VH																										
HSTO																										
AFCG							8C													30						
fV																										
Vfree							8C				C0															
SVC																				18						
FPVU							8C																			
FPVL							8C																			
VRsi 1							8C																			
VRsc 1							8C											30								
VRsc 2							8C											00								
VRpo 1							8C																			
VRpo 2							8C													17						
VW							8C																			
VBLKW							8C		00																	
WVSS							8C																			

Symbol	Parameter	Input signal		Test point	Limits			Unit	Remarks
		Pins	SG		Min.	Typ.	Max.		
MONITORING	Standard condition of Intelligent monitor	-	-	-	-	-	-	-	pin13=5V, pin27=0V
MONI1	Intelligent monitoring 1 (AFT)	64,1	SG.7	43	2.0	2.5	3.0	V	At which AFT voltage is 2.5V
MONI2-1	Intelligent monitoring 2-1 (RF AGC1)	-	-	43	3.75	3.95	4.15	V	At which RF AGC voltage is High
MONI2-2	Intelligent monitoring 2-2 (RF AGC2)	64,1	SG.7	43	0.9	0.95	1.00	-	pin43 voltage / pin62 voltage
MONI3	Intelligent monitoring 3 (Audio direct out)	47	SG.16	43	280	460	740	mV _{rms}	
MONI4	Intelligent monitoring 4 (Audio bypass)	47	SG.16	43	2.05	2.45	2.85	V	
MONI5	Intelligent monitoring 5 (Video SW output)	36	SG.A	43	0.76	0.95	1.24	V _{pp}	
MONI6	Intelligent monitoring 6 (G out)	36	SG.A	43	1.5	2.0	2.5	V _{pp}	Measure amplitude from blanking level.
MONI7	Intelligent monitoring 7 (R out)	36	SG.A	43	1.5	2.0	2.5	V _{pp}	Measure amplitude from blanking level.
MONI8	Intelligent monitoring 8 (B out)	36	SG.A	43	1.5	2.0	2.5	V _{pp}	Measure amplitude from blanking level.
MONI9	Intelligent monitoring 9 (ACL)	-	-	43	3.6	4.0	4.4	V	
MONI10	Intelligent monitoring 10 (Composit sync)	36	SG.A	43	3.50	3.95	4.40	V _{pp}	
MONI11	Intelligent monitoring 11 (H out)	36	SG.A	43	2.4	2.8	3.2	V _{pp}	
MONI12	Intelligent monitoring 12 (VIF Vcc)	-	-	43	2.35	2.50	2.65	V	
MONI13	Intelligent monitoring 13 (Start-up Vcc)	-	-	43	2.55	2.70	2.85	V	
MONI14	Intelligent monitoring 14 (Video/chroma Vcc)	-	-	43	2.35	2.50	2.65	V	
MONI15	Intelligent monitoring 15 (Hi Vcc)	-	-	43	2.55	2.70	2.85	V	

Symbol	SUB ADDRESS																									
	00H	01H	02H	03H	04H	05H	06H	07H	08H	09H	0AH	0BH	0CH	0DH	0EH	0FH	10H	11H	12H	13H	14H	15H	16H	17H	1BH	1CH
MONITORING	40	adj	00	00	20	40	88	40	40	F0	80	40	40	80	80	80	24	20	00	10	00	00	00	00	00	00
MONI1																			10							
MONI2-1																			20							
MONI2-2																			20							
MONI3																			30							
MONI4																			40							
MONI5																			50							
MONI6									00										60							
MONI7									00										70							
MONI8									00										80							
MONI9																			90							
MONI10																			A0							
MONI11																			B0							
MONI12																			C0							
MONI13																			D0							
MONI14																			E0							
MONI15																			F0							

Electrical characteristics test method

VIF BLOCK

P/N : Video S/N

1. Input SG3 and measure the rms value of output signal at pin 57.
2. P/N is defined as follows:

$$P/N = 20 \log \frac{V_o \text{ measured value}(V_{p-p}) \times 10^3 \times 0.7}{\text{Noise measured value}(mV_{rms})} \text{ (dB)}$$

Vf : Video frequency characteristics

1. Input SG4 and set the frequency f₂ to 44.75MHz so that the beat element of 1MHz is output to pin 57.
2. Then set the applied voltage at pin 63 so that the beat element of 1MHz at pin 64 may be 100dBμ.
3. Decrease f₂ to the level at which the beat element becomes 3dB smaller than the element of 1MHz, and read the value at that level.

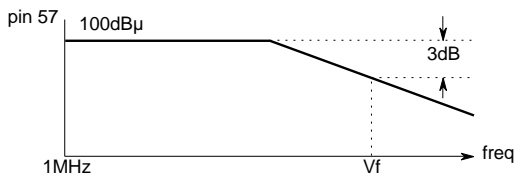

Vin min : Input sensitivity

1. Decrease SG5 level until the video detector output is 3dB smaller than the measured value of Parameter Vo "Video detector output".

Vin max : Maximum permissible input

1. Input 90dBμ SG6.
2. V_A is the output level at pin 57. Increase amplitude of SG6 until the output at pin 57 becomes 3dB smaller than V_A. The input level at that time is the maximum permissible input.

μAFT : AFT detector sensitivity

V2H : Maximum AFT voltage

V2L : Minimum AFT voltage

See the following figure.

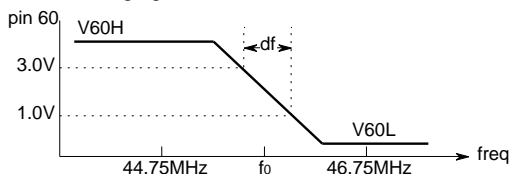

μAFT is defined as follows:

$$\mu AFT = \frac{(3.0-1.0) \times 10^3 mV}{df \text{ KHz}} \text{ (mV/KHz)}$$

IM : Intermodulation

1. Input SG13 to pins 64 and 1.
2. Measure elements of 0.92MHz and 3.58MHz of output at pin 57.
3. IM is defined as follows:

$$IM = 20 \log \frac{\text{Element of 0.92MHz}}{\text{Element of 3.58MHz}} \text{ (dB)}$$

DLPH : Maximum RF AGC delay point

DLPL : Minimum RF AGC delay point

1. Input SG5 to pins 64 and 1.
2. Change amplitude of SG5 to the level at which voltage of pin 62 becomes 2.5V, and read the value at that level.

SIF, QIF BLOCK

LIM : Input limiting sensitivity

Decrease the input level of SG19. Measure the input level when the element of 400Hz at pin 57 is 3dB smaller than VoAF P (Maximum AF output (5.5M)).

AMR : AM Rejection

1. V_{am} is the element of 400Hz at pin 53.
2. AMR is defined as follows:

$$AMR = 20 \log \frac{V_{oAF} P(mV_{rms})}{V_{am}(mV_{rms})} \text{ (dB)}$$

AFSN : AF S/N

1. Measure the noise (20Hz to 100KHz) of output at pin 50.
2. AFSN is defined as follows:

$$AF \text{ S/N} = 20 \log \frac{V_{oAF} \text{ max}}{\text{Measured value}} \text{ (dB)}$$

FM-SM : FM mode S/N

1. Set FM Radio and SPLIT control data to 'ON'.
2. Input SG22 (v_i=85dBμ) to pins 64 and 1.
3. Measure the noise (20Hz to 100KHz) of output at pin 53.
4. FM-SN is defined as follows:

$$FM-SN = 20 \log \frac{FM-V_{oAF}}{\text{Measured value}} \text{ (dB)}$$

FM-OUT : FM mode video detector output

1. Set FM Radio and SPLIT control data to 'ON'.
2. Input SG23 to pins 64 and 1.
3. Measure the DC voltage of output at pin 57.

VIDEO BLOCK

2AGTV :Video SW output level (TV input)
 2AGEV :Video SW output level (External input)

1. Input SG.A to pin 36 (2AGTV) or pin 34 (2AGEV).
2. Measure the amplitude (peak to peak) at pin 40.

Note : use sub address 06H to select TV or external video input.

Ymax : Maximum video output

1. Input SG.A to pin 34.
2. Measure the amplitude (peak to peak) except measure from blanking part of output at pins 14, 15 and 16.

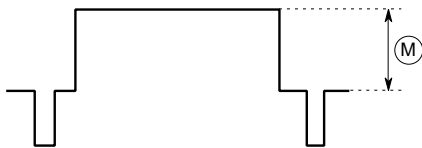

FBY : Video frequency characteristics

1. Input SG.B (5MHz, 0.4V_{p-p}) to pin 34.
2. Measure the amplitude (peak to peak) except measure from blanking part of the output at pins 14, 15 and 16. The amplitude is defined as YB.
3. FBY is defined as follows:

$$FBY = 20 \log \frac{YB V_{p-p}}{GY V_{p-p}} \text{ (dB)}$$

CRF : Chroma trap attenuation (common to R/G/B output)

TRF : Chroma trap maximum attenuation

1. Input SG.C to pin 34. Measure the frequency level of 3.58MHz at trap on/off (02H D4) data 1. The level is defined as N₀.
2. Then, measure the level at trap on/off data 1 (trap active).
3. CRF is defined as follows.

$$CRF = 20 \log \frac{\text{Measured value (mV}_{p-p})}{N_0 \text{ (mV}_{p-p})} \text{ (dB)}$$

4. TRF is minimum value of CRF at which I²C bus data of Trap fine adj. (12H D0/D1) is adjusted.

YDL1 : Y delay time 1

1. Input SGA to pin 34.
2. Measure the delay time from signal input to output at pins 14, 15 and 16.

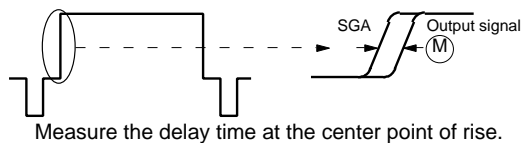

YDL2, 3 and 4 : Y delay time 2, 3 and 4

1. Input SGA to pin 34.
2. Measure the delay time from signal input to output at pins 14, 15 and 16.
3. YDL2, YDL3 and YDL4 are defined as follows:

$$\begin{aligned} YDL2 &= \text{Measured value (nsec)} - YDL1 \\ YDL3 &= \text{Measured value (nsec)} - YDL2 \\ YDL4 &= \text{Measured value (nsec)} - YDL3 \end{aligned}$$

GTmax : Video tone control characteristic 1

1. Input SG.B (f=2.5MHz) to pin 34.
2. The output amplitude at pins 14, 15 and 16 when video tone data is center (20H) are defined as GT_{nor}.
3. Measure output amplitude at pins 14, 15 and 16 at video tone data maximum.
4. GT_{max} is defined as follows:

$$GT_{max} = 20 \log \frac{\text{Measured value (mV}_{p-p})}{GT_{nor} \text{ (mV}_{p-p})} \text{ (dB)}$$

GTmin : Video tone control characteristic 2

1. Input SG.B (f=2.5MHz) to pin 34.
2. The output amplitude at pins 14, 15 and 16 when video tone data is center (20H) are defined as GT_{nor}.
3. Measure output amplitude at pins 14, 15 and 16 at video tone data minimum.
4. GT_{min} is defined as follows:

$$GT_{min} = 20 \log \frac{\text{Measured value (mV}_{p-p})}{GT_{nor} \text{ (mV}_{p-p})} \text{ (dB)}$$

GT1M : Video tone control characteristic 3

1. The output amplitude at pins 14, 15 and 16 when frequency of input signal is 2.5MHz are defined as GT_{nor}.
2. Input SG.B (f=2MHz) to pin 34.
3. Measure output amplitude at pins 14, 15 and 16.
4. GT_{2M} is defined as follows:

$$GT_{2M} = 20 \log \frac{\text{Measured value (mV}_{p-p})}{GT_{nor} \text{ (mV}_{p-p})} \text{ (dB)}$$

GT5M : Video tone control characteristic 4

1. The output amplitude at pins 14, 15 and 16 when frequency of input signal is 2.5MHz are defined as GT_{nor}.
2. Input SG.B (f=5MHz) to pin 34.
3. Measure output amplitude at pins 14, 15 and 16.
4. GT_{5M} is defined as follows:

$$GT_{5M} = 20 \log \frac{\text{Measured value (mV}_{p-p})}{GT_{nor} \text{ (mV}_{p-p})} \text{ (dB)}$$

BLS Black stretch characteristics

1. Input SG.K to pin 34.
2. At condition of Black stretch OFF (06H D3=1), set output level of the first step (the lowest step) to 2.0V and eighth step (the highest step) to 4.6V at pins 14, 15 and 16 by adjusting Contrast (05H) and Brightness (0AH).
3. Change to Black stretch ON (06H D3=0), and measure the output level of the first step at pins 14, 15 and 16.
4. BLS is defined as follows:

$$BLS = 2.0 - \text{Measured value (V)}$$

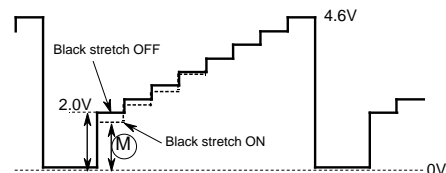

VMF Video mute characteristics

1. Input SG.A to pin 34.
2. Measure output amplitude when mute switch (02H D7) is on "VMFon" and off "VMFoff".
3. VMF is defined as follows:

$$VMF = 20 \log \frac{VMF_{on} \text{ (V}_{p-p})}{VMF_{off} \text{ (V}_{p-p})} \text{ (dB)}$$

CHROMA BLOCK

CnorR : Standard chroma output (R-Y)
 CnorB : Standard chroma output (B-Y)

1. Input SG.C to pin 34.
2. CnorR and CnorB are output amplitude measured at pin 62 when I²C data of 'test mode' 16H D6=1, D7=1 and D6=0, D7=1 respectively.

ACC1: ACC characteristics 1

1. Input SG.E (eb=570mV:level+6dB) to pin 34.
2. Measure the output amplitude at pin 62.
3. ACC1 is defined as follows:

$$ACC1 = 20 \log \frac{\text{Measured value (mV}_{p-p})}{Cnor1 (mV}_{p-p})} \text{ (dB)}$$

ACC2: ACC characteristics 2

1. Input SG.E (input level:-20dB) to pin 34.
2. Measure the output amplitude at pin 62.
3. ACC2 is defined as follows:

$$ACC2 = 20 \log \frac{\text{Measured value (mV}_{p-p})}{Cnor1 (mV}_{p-p})} \text{ (dB)}$$

OV : Chroma overload characteristics

1. Input SG.E (ec=800mV_{p-p}:chroma+3dB) to pin 34.
2. Measure the output amplitude at pin 62.
3. OV is defined as follows:

$$OV = 20 \log \frac{\text{Measured value (mV}_{p-p})}{Cnor1 (mV}_{p-p})} \text{ (dB)}$$

VikN1 : Killer operating input level 1

VikN2 : Killer operating input level 2

1. Input SG.E (level:variable) to pin 34 at input level 0dB.
2. Lower the input level while monitoring the output amplitude at pin 62, and measure the input level when output amplitude is not found.

KillP : Killer color residual

1. Input SG.E (level:-40dB) to pin 34.
2. Measure the output amplitude at pin 62.

APCU : APC pull-in range (Upper)

APCL : APC pull-in range (Lower)

1. Input SG.E (feb=fec=3.579545MHz) to pin 34.
2. Increase the frequency until the output from pin 62 disappears. Decrease the frequency and note the point at which the output reappears; f_u.
3. Decrease the frequency until the output from pin 62 disappears. Increase the frequency and note the point at which the output reappears; f_L.
4. APCU and APCL are defined as follows:

$$APCU = f_u - 357954500 \text{ (Hz)}$$

$$APCL = f_L - 357954500 \text{ (Hz)}$$

R/BN : Demodulation output ratio

1. Input SG.E (eb=single chroma=ec+50KHz) to pin 34.
2. V_{RY} is the output amplitude at pin 62 when I²C bus data of 'test mode' 16H D6=1, D7=1 .
3. V_{BY} is the output amplitude at pin 62 when I²C bus data of 'test mode' 16H D6=0, D7=1 .
4. R/BN is defined as follows:

$$R/BN = \frac{V_{RY} (mV_{p-p})}{V_{BY} (mV_{p-p})}$$

R-YN : Demodulated phase angle

1. Input SG.E (eb=single chroma=ec+50KHz) to pin 34.
2. V_{RY} is the output amplitude at pin 62 when I²C bus data of 'test mode' 16H D6=1, D7=1 .
3. V_{BY} is the output amplitude at pin 62 when I²C bus data of 'test mode' 16H D6=0, D7=1 .
4. R-YN is defined as follows:

$$R-YN = \tan^{-1} \frac{V_{RY} \times 3.8}{(V_{BY} \times 1.9) + 45} \text{ (deg)}$$

Note: Vector should be found with taking the gain ratio of a demodulator into consideration.

TC1 : Tint control characteristics 1

TC2 : Tint control characteristics 2

1. Input SG.C (see the following figure) to pin 34. Based on the output voltage at pin 62, find the absolute angle as shown in the above figure.

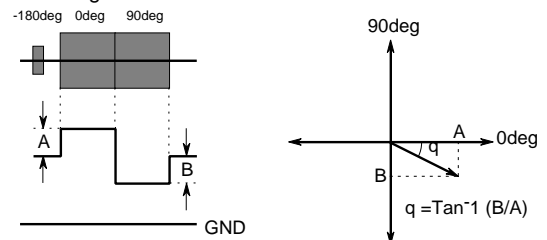

2. Tint data center (07H data 40H) is defined as the reference angle "TC". Find angles at tint data maximum and tint data minimum. TC1 and TC2 are differences in angle between TCmax and TC and between TCmin and TC and defined as follows.

$$TC1 = TC_{max} - TC \text{ (deg)}$$

$$TC2 = TC - TC_{min} \text{ (deg)}$$

RGB INTERFACE BLOCK

VBLK : Output blanking voltage

1. Input SG.A to pin 34.
2. Measure the voltage of pedestal part and blanking part at pins 14, 15 and 16.

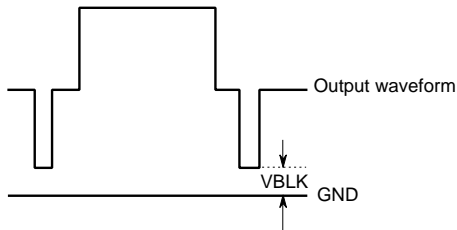

GYmax : Contrast control characteristic 1

GYmin : Contrast control characteristic 2

1. Input SG.B (f=100KHz) to pin 34.
2. Measure output amplitude at pins 14, 15 and 16.

GYEnor : Contrast control characteristic 3

GYEmin : Contrast control characteristic 4

1. Input SG.A to pin 34.
2. Measure output amplitude at pins 14, 15 and 16 when 2.9V and 0V are externally applied to pin 31.

GYEcrip : Contrast control characteristic 5

1. Input SG.F to pins 20, 27, 28 and 30.
2. Set contrast control data to minimum and measure the output amplitude which is higher than the pedestal level at pins 14, 15 and 16. The amplitude at blanking part should not be measured.

Lum nor : Brightness control characteristic 1

Lum max : Brightness control characteristic 2

Lum min : Brightness control characteristic 3

1. Input SG.D (Vy=0V) to pin 34.
2. Measure DC voltage of output at pins 14, 15 and 16 except that at blanking part.

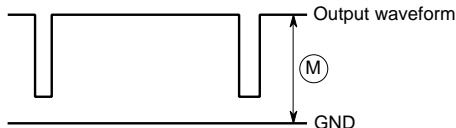

D(R)1 : Drive control characteristic 1 (R)

1. Input SG.A to pin 34.
2. Measure DRnor and DRmax which are output amplitude at pin 14 at Drive (R) data center and Drive (R) data maximum respectively.
3. D(R)1 is defined as follows:

$$D(R)1 = 20 \log \frac{DRmax (V_{p-p})}{DRnor (V_{p-p})} \text{ (dB)}$$

D(B)1 : Drive control characteristic 1 (B)

1. Input SG.A to pin 34.
2. Measure DBnor and DBmax which are output amplitude at pin 16 at Drive(B) data center and Drive(B) data maximum respectively.
3. D(B)1 is defined as follows:

$$D(B)1 = 20 \log \frac{DBmax (V_{p-p})}{DBnor (V_{p-p})} \text{ (dB)}$$

D(R)2 : Drive control characteristic 2 (R)

1. Input SG.A to pin 34.
2. Measure DRnor and DRmin which are output amplitude at pin 14 at Drive(R) data center and Drive(R) data minimum respectively.
3. D(R)2 is defined as follows:

$$D(R)2 = 20 \log \frac{DRmin (V_{p-p})}{DRnor (V_{p-p})} \text{ (dB)}$$

D(B)2 : Drive control characteristic 2 (B)

1. Input SG.A to pin 34.
2. Measure DBnor and DBmin which are output amplitude at pin 16 at Drive(B) data center and Drive(B) data minimum respectively.
3. D(B)2 is defined as follows:

$$D(B)2 = 20 \log \frac{DBmin (V_{p-p})}{DBnor (V_{p-p})} \text{ (dB)}$$

EXD(R) : Digital OSD (R) I/O characteristic

EXD(G) : Digital OSD (G) I/O characteristic

EXD(B) : Digital OSD (B) I/O characteristic

1. Input SG.F (Vosd=1.0V) to pins 20, 27, 28 and 30.
2. Measure output amplitude which is higher than the pedestal level at pins 14, 15 and 16. The amplitude at blanking part should not be measured.

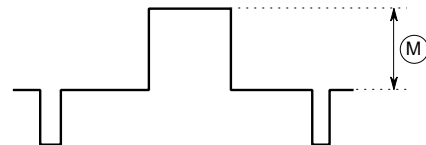

EXD(R-G) : Digital OSD level difference R and G

EXD(G-B) : Digital OSD level difference G and B

EXD(B-R) : Digital OSD level difference B and R

1. EXD(R-G), EXD(G-B) and EXD (B-R) are defined as follows:

$$EXD(R-G) = EXD(R) - EXD(G)$$

$$EXD(G-B) = EXD(G) - EXD(B)$$

$$EXD(B-R) = EXD(B) - EXD(R)$$

EXA(R) : Analog OSD (R) I/O characteristic

EXA(G) : Analog OSD (G) I/O characteristic

EXA(B) : Analog OSD (B) I/O characteristic

1. Input SG.F (Vosd=0.7V) to pins 20, 27, 28 and 30.
2. Measure output amplitude which is higher than the pedestal level at pins 14, 15 and 16. The amplitude at blanking part should not be measured.

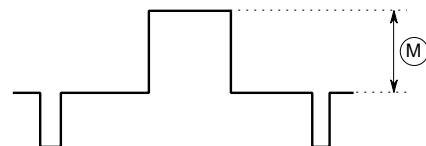

EXA(R-G) : Analog OSD level difference R and G

EXA(G-B) : Analog OSD level difference G and B

EXA(B-R) : Analog OSD level difference B and R

1. EXA(R-G), EXA(G-B) and EXA (B-R) are defined as follows:

$$EXA(R-G) = EXA(R) - EXA(G)$$

$$EXA(G-B) = EXA(G) - EXA(B)$$

$$EXA(B-R) = EXA(B) - EXA(R)$$

M61206FP

NTSC TV SIGNAL PROCESSOR

OFEXR : Offset voltage between R and EXT(R)
 OFEXG : Offset voltage between G and EXT(G)
 OFEXB : Offset voltage between B and EXT(B)

1. Input SG.D (Vy=0V) to pin 34.
2. Measure DC voltage of output at pins 14, 15 and 16 except that at blanking part.
3. The voltage when RGB output is defined as VR, VG and VB, and the voltage when OSD output is defined as VEXR, VEXG and VEXB.
4. OFEXR, OFEXG and OFEXB are defined as follows:

$$\begin{aligned} \text{OFEXR} &= V_R - V_{\text{EXR}} \text{ (V)} \\ \text{OFEXG} &= V_G - V_{\text{EXG}} \text{ (V)} \\ \text{OFEXB} &= V_B - V_{\text{EXB}} \text{ (V)} \end{aligned}$$

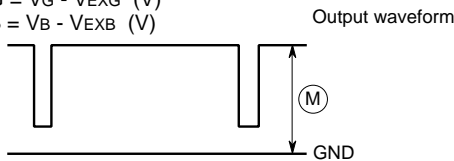

C(R)1 : R cutoff characteristic 1
 C(G)1 : G cutoff characteristic 1
 C(B)1 : B cutoff characteristic 1
 C(R)2 : R cutoff characteristic 2
 C(G)2 : G cutoff characteristic 2
 C(B)2 : B cutoff characteristic 2

1. Input SG.D (Vy=0V) to pin 34.
2. Measure DC voltage of output at pins 14, 15 and 16 except that at blanking part.

Ccon1 : Color control characteristic 1
 Ccon2 : Color control characteristic 2
 Ccon3 : Color control characteristic 3

1. Input SG.C to pin 34.
2. Measure output amplitude at pins 14, 15 and 16 when I²C data 08H=40h, and define as Ccon0
2. Measure output amplitude at pins 14, 15 and 16 under each condition.
3. Ccon1, Ccon2 and Ccon3 are defined as follows:

$$\begin{aligned} &\text{Ccon1, Ccon2 and Ccon3} \\ &= 20 \log \frac{\text{Measured value (V}_{p-p})}{\text{Ccon0 (V}_{p-p})} \text{ (dB)} \end{aligned}$$

MTXRB : Matrix ratio R/B
 MTXGB : Matrix ratio G/B

1. Input SG.G (rainbow color bar) to pin 34.
2. Measure output amplitude VR, VG and VB at pins 14, 15 and 16 respectively.
3. MTXRB and MTXGB are defined as follows:

$$\begin{aligned} \text{MTXRB} &= \frac{V_R (V_{p-p})}{V_B (V_{p-p})} \\ \text{MTXGB} &= \frac{V_G (V_{p-p})}{V_B (V_{p-p})} \end{aligned}$$

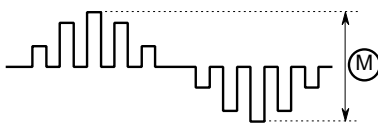

DOSD1 : Digital OSD speed characteristic 1
 DOSD2 : Digital OSD speed characteristic 2

1. Input SG.F (Vosd=1.0V) to pins 20, 27, 28, 30.
2. Measure rise time and fall time of the signal of output at pins 14, 15 and 16. Measurement points should be higher than the pedestal level and blanking part should not be measured.

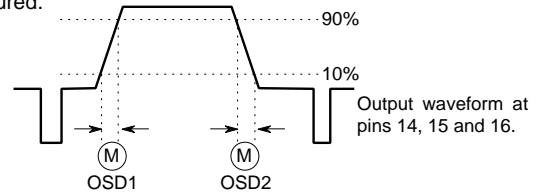

AOSD1 : Analog OSD speed characteristic 1
 AOSD2 : Analog OSD speed characteristic 2

1. Input SG.F (Vosd=0.7V) to pins 20, 27, 28, 30.
2. Measure rise time and fall time of the signal of output at pins 14, 15 and 16. Measurement points should be higher than the pedestal level and blanking part should not be measured.

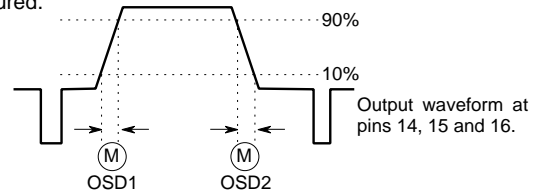

BB(R) : Blue back function (R)
 BB(G) : Blue back function (G)
 BB(B) : Blue back function (B)

1. Input SG.A to pin 34.
2. Measure the amplitude (peak to peak) except measure from blanking part of output at pins 14, 15 and 16.

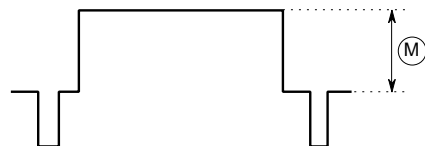

WB : White raster function

1. Input SG.A to pin 34.
2. Measure the amplitude (peak to peak) except measure from blanking part of output at pins 14, 15 and 16.

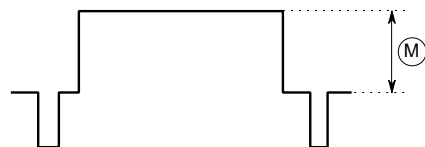

DEFLECTION BLOCK

fH1 : Horizontal free-running frequency 1
 fH2 : Horizontal free-running frequency 2
 fH3 : Horizontal free-running frequency 3

Measure the output frequency at pin 7 when no signal is input.

Hfree : Forced horizontal free-running frequency

1. Input SG.A to pin 34.
2. Set H-free control data to 'ON', and measure the output frequency at pin 7.

FPHU : Horizontal pull-in range (upper)

FPHL : Horizontal pull-in range (lower)

1. Input SG.H to pin 34.
2. Change the frequency of SG.H, and measure the frequency at the moment when the output signal at pin 7 and the input signal at pin 34 are pulled in. The horizontal pull-in range is measured by comparing with the horizontal frequency of video signal.

HPT1 : Horizontal pulse timing 1

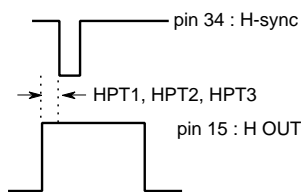

HPT2 : Horizontal pulse timing 2
 HPT3 : Horizontal pulse timing 3

1. Measure the timing of horizontal pulse as same method in HPT1.
2. HPT2 and HPT3 are defined as follows:
 $HPT2, HPT3 = (\text{Measured value}) - HPT1$

HPTW : Horizontal pulse width
 VH : Horizontal pulse amplitude

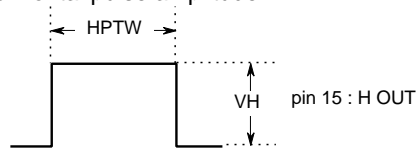

HSTO : Horizontal stop operation

Confirm that the horizontal output is high when the horizontal stop switch is on.

AFCG : AFC gain operation

1. Measure AFCOn which is the output amplitude of pin 19 when AFC switch is on and AFCoff which is that when the switch is off.
2. AFCG is defined as follows:

$$AFCG = 20 \log \frac{AFCOn (V_{p-p})}{AFCoff (V_{p-p})} \text{ (dB)}$$

fV : Vertical free run frequency

Measure the output frequency at pin 17 when no signal is input.

Vfree : Forced vertical free-running frequency

1. Input SG.A to pin 34.
2. Set V-free control data to 'ON', and measure the output frequency at pin 17.

SVC : Service mode function

Measure the output DC voltage at pin 17 when the service switch is on.

FPVU : Vertical pull-in frequency (upper)

FPVL : Vertical pull-in frequency (lower)

Change the vertical frequency of SG.H and measure the frequency when output waveform at pin 17 is pulled in.

VRsi : Vertical ramp size

VRsc1 : Vertical ramp size control range 1

VRsc2 : Vertical ramp size control range 2

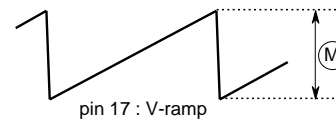

VRpo1 : Vertical ramp position control range 1

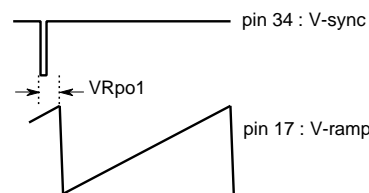

VRpo2 : Vertical ramp position control range 2

1. Measure the timing of vertical ramp as same method in VRpo1
2. VRpo2 is defined as follows:

$$VRpo2 = (\text{Measured value}) - VRpo1$$

VW : Vertical pulse width

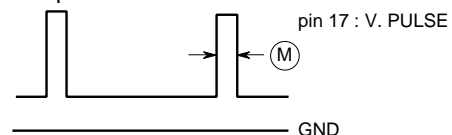

VBLKW : Vertical BLK width

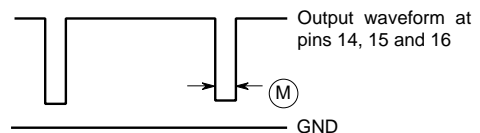

WVSS : Minimum sync detection width

Reduce the width of signal SG.I and measure the width of input signal when the output waveform at pin 17 loses lock with SG.I.

M61206FP

NTSC TV SIGNAL PROCESSOR

APPLICATION CIRCUIT (EVALUATION BOARD CIRCUIT)

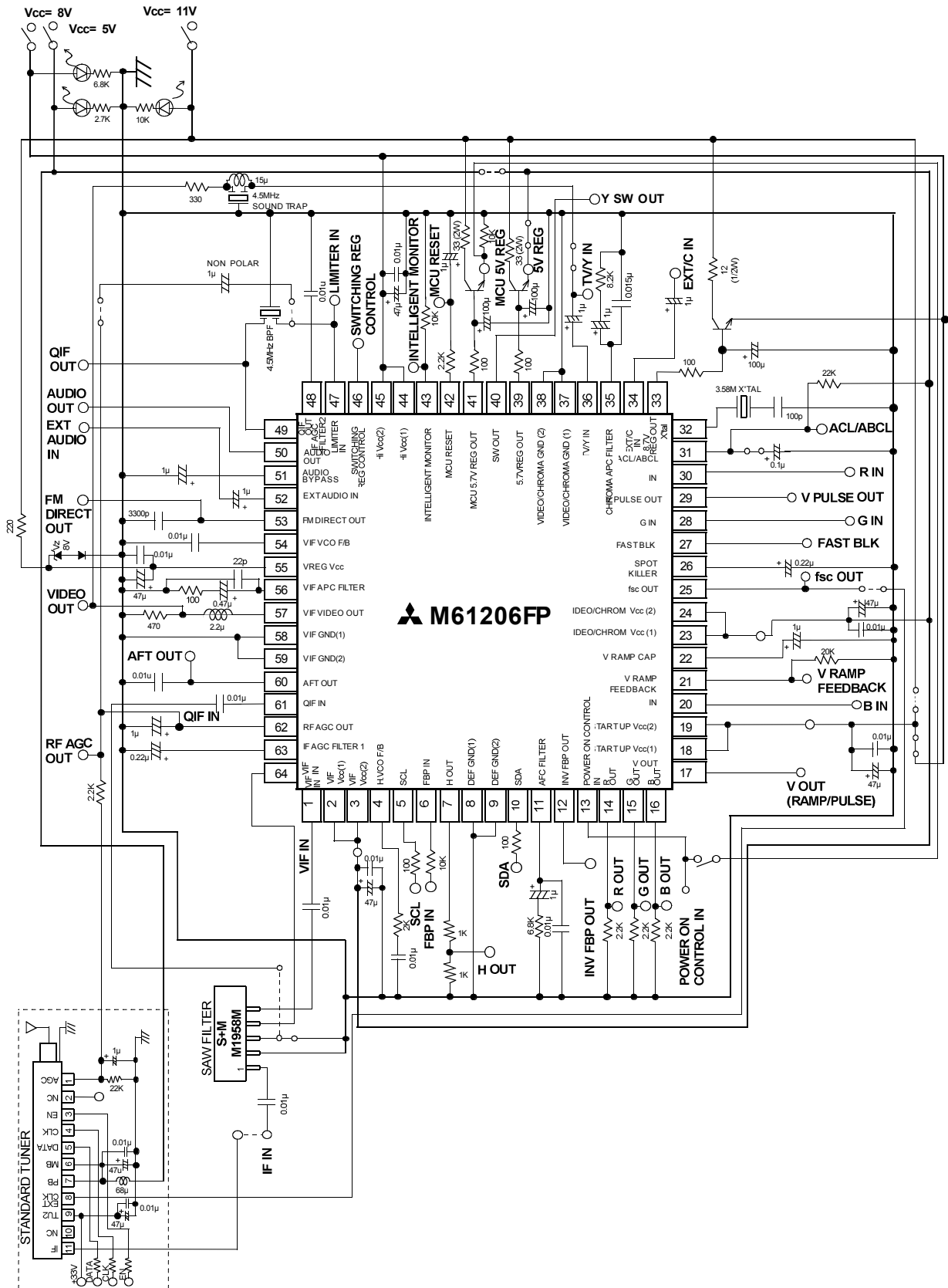

M61206FP

NTSC TV SIGNAL PROCESSOR

PIN DESCRIPTION

Pin No.	Name	Peripheral circuit of pins	DC Voltage (V)
64 1	VIF IN (1) VIF IN (2)		1.6V
2 3	VIF Vcc (1) VIF Vcc (2)		5.0V
4	H VCO FEEDBACK		3.0V
5	SCL		$V_{IL} : 0.75V$ $V_{IH} : 4.25V$

M61206FP

NTSC TV SIGNAL PROCESSOR

Pin No.	Name	Peripheral circuit of pins	DC Voltage (V)
6	FBP IN		$V_{TH} : 2.0V$ (FBP Vth L=OFF) $V_{TH} : 1.0V$ (FBP Vth L=ON)
7	H OUT		$V_{OL} : 0.0V$ $V_{OH} : 5.4V$
8	DEF GND (1)		
9	DEF GND (2)		
10	SDA		$V_{IL} : 0.75V$ $V_{IH} : 4.25V$

M61206FP

NTSC TV SIGNAL PROCESSOR

Pin No.	Name	Peripheral circuit of pins	DC Voltage (V)
11	AFC FILTER		3.5V
12	FBP INV OUT		VOL : 0.0V VOH : 5.0V
13	POWER ON CONTROL		V _{TH} : 3.0V
14 15 16	R OUT G OUT B OUT		

M61206FP

NTSC TV SIGNAL PROCESSOR

Pin No.	Name	Peripheral circuit of pins	DC Voltage (V)
17	V OUT		4.6V
18 19	START UP Vcc (1) START UP Vcc (2)		
20	B IN		(1) Digital OSD $V_{IL} : 0.0V$ $V_{IH} : 1.0V$ (2) Analog OSD $0.7V_{pp}$
21 22	V RAMP FEED BACK V RAMP CAP		

M61206FP

NTSC TV SIGNAL PROCESSOR

Pin No.	Name	Peripheral circuit of pins	DC Voltage (V)
23 24	Video/Chroma Vcc (1) Video/Chroma Vcc (2)	—————	5.0V
25	fsc OUT		3.0V
26	SPOT KILLER		7.1V
27	FAST BLK		0.0-0.5V: INT RGB 1.5-3.0V: EXT RGB 4.0-5.0V: BLK

M61206FP

NTSC TV SIGNAL PROCESSOR

Pin No.	Name	Peripheral circuit of pins	DC Voltage (V)
28	R IN		(1) Digital OSD $V_{IL} : 0.0V$ $V_{IH} : 1.0V$ (2) Analog OSD $0.7V_{pp}$
29	V PULSE OUT		$V_{OL} : 0.0V$ $V_{OH} : 5.0V$
30	R IN		(1) Digital OSD $V_{IL} : 0.0V$ $V_{IH} : 1.0V$ (2) Analog OSD $0.7V_{pp}$
31	ACL/ABCL		

M61206FP

NTSC TV SIGNAL PROCESSOR

Pin No.	Name	Peripheral circuit of pins	DC Voltage (V)
32	X-TAL		3.3V
33	8.7 VREG OUT		8.7V
34	EXT/C IN		1.7V
35	CHROMA APC FILTER		3.2V

M61206FP

NTSC TV SIGNAL PROCESSOR

Pin No.	Name	Peripheral circuit of pins	DC Voltage (V)
36	TV/Y IN		1.7V
37 38	Video/Chroma GND(1) Video/Chroma GND (2)		0.0V
39	5.7 VREG OUT		5.7V
40	Y SW OUT		1.7V

M61206FP

NTSC TV SIGNAL PROCESSOR

Pin No.	Name	Peripheral circuit of pins	DC Voltage (V)
41	MCU 5.7VREG OUT		5.7V
42	MCU RESET		H: 5.0V L: 0.0V
43	INTELLIGENT MONITOR		
44 45	Hi Vcc (1) Hi Vcc (2)		8V

M61206FP

NTSC TV SIGNAL PROCESSOR

Pin No.	Name	Peripheral circuit of pins	DC Voltage (V)
46	SWITCHING REG CONTROL		Open Collector
47	LIMITER IN		2.5V
48	IF AGC FILTER 2		2.3V
49	QIF OUT		2.3V

M61206FP

NTSC TV SIGNAL PROCESSOR

Pin No.	Name	Peripheral circuit of pins	DC Voltage (V)
50	AUDIO OUT		2.3V
51	AUDIO BYPASS		2.3V
52	EXT AUDIO IN		2.3V
53	FM DIRECT OUT		2.3V

M61206FP

NTSC TV SIGNAL PROCESSOR

Pin No.	Name	Peripheral circuit of pins	DC Voltage (V)
54	VIF VCO FEEDBACK		3.0V
55	VREG Vcc		8.7V
56	VIF APC FILTER		3.0V
57	VIDEO OUT		2.7V

M61206FP

NTSC TV SIGNAL PROCESSOR

Pin No.	Name	Peripheral circuit of pins	DC Voltage (V)
58 59	VIF GND (1) VIF GND (2)	_____	
60	AFT OUT		0.3 ~ 4.7V
61	QIF IN		2.7V
62	RF AGC OUT		0.3 ~ 4.7V
63	IF AGC FILTER 1		2.3V