

Surface Mount PIN Diodes

MA4P1250, MA4P1450 SMQ™

V3.00

Features

- Non-Rollable MELF Design
- Hermetically Sealed
- Low Loss, Low Distortion
- Passivated PIN Diode Chips
- Full Face Chip Bonds
- Non-Magnetic Package
- Pick and Place Compatibility

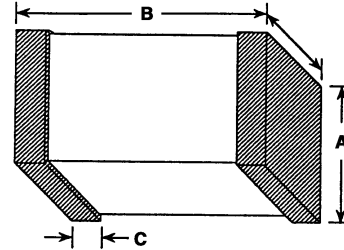

Description

The MA4P1250 and MA4P1450 are square surface mountable PIN diodes in a non-rollable, metal electrode leadless faced (MELF) package. They incorporate passivated PIN diode chips that are full face bonded to refractory metal pins. These parts utilize M/A-COM's HIPAX technology in a low inductance ceramic package with no ribbons or whisker wires. The package is hermetically sealed at temperatures exceeding 300°C.

		Size, Inches (mm)		
Model No.	Case Style	A(sq.) Min./Max.	B Min./Max.	C Min./Max.
MA4P1250	1072	0.080/0.095 (2.03/2.41)	0.115/0.135 (2.92/3.43)	0.008/0.030 (0.203/0.762)
MA4P1450	1091	0.138/0.155 (3.51/3.94)	0.180/0.200 (4.57/5.08)	

Applications

The MA4P1250 is designed for use as a low loss switching element from HF through UHF. Its high power rating allows performance in antenna switch elements at RF power levels greater than 100 watts CW. It is designed to meet the low distortion requirements of mobile radios.

The MA4P1450 is a higher power diode. It has lower distortion at RF CW power greater than 10 watts and can dissipate 7.5 watts.

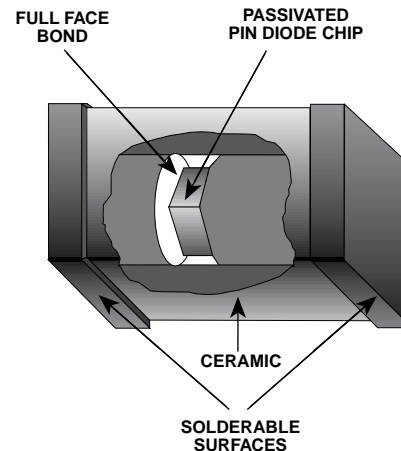

Designed for Automated Assembly

These surface mount PIN diodes are designed for high volume tape and reel assembly. The square package eases automatic pick and place indexing and assembly. The parallel flat surfaces are suitable for key jaw or vacuum pickup techniques. All solderable surfaces are tin plated and compatible with reflow and vapor phase soldering methods.

Environmental Capability

These HIPAX diodes are applicable for use in industrial and military applications. They can meet the environmental requirements of MIL-STD-750 and MIL-STD-202 or be screened to JAN-TX and other high reliability standards.

SMQ is a trademark of M/A-COM, Inc.
Specifications Subject to Change Without Notice.

M/A-COM, Inc.

North America: Tel. (800) 366-2266 ■ Asia/Pacific: Tel. +81 3 3263 8761 ■ Europe: Tel. +44 (1344) 869 595
Fax (800) 618-8883 Fax +81 3 3263 8769 Fax +44 (1344) 300 020

Electrical Specifications @ 25°C (MA4P1250)

Parameter	Minimum	Typical	Maximum	Unit	Condition
Series Resistance	—	0.5	0.75	Ω	F = 100 MHz I = 50 mA
Capacitance	—	0.9	1.2	pF	F = 1 MHz V = 50 V
Parallel Resistance	5 K	10 K	—	Ω	F = 100 MHz V = 0 V
Carrier Lifetime	2.0	4.0	—	μs	I = 10 mA
Forward Bias Harmonic Distortion (R _a ^{2a} , R _a ^{3a})	80	90	—	dBc	F = 100 MHz P = 30W I = 50 mA
Reverse Bias Harmonic Distortion (R _a ^{2a} , R _a ^{3a})	60	70	—	dBc	F = 100 MHz P = 0 dBm V = 0 V
Voltage Rating	50	—	—	V	I = 10 μA
Forward Voltage	—	1.0	—	V	I = 50 mA

* Available only in case style 1072.

Absolute Maximum Ratings @ 25°C

Parameter	Absolute Maximum
Voltage	50 Volts
Operating Temperature	-65°C to +175°C
Storage Temperature	-65°C to +175°C
Power Dissipation	
Free Air	1.5 Watts
Contact Surfaces @ +25°C	4.0 Watts

Typical Performance Curves

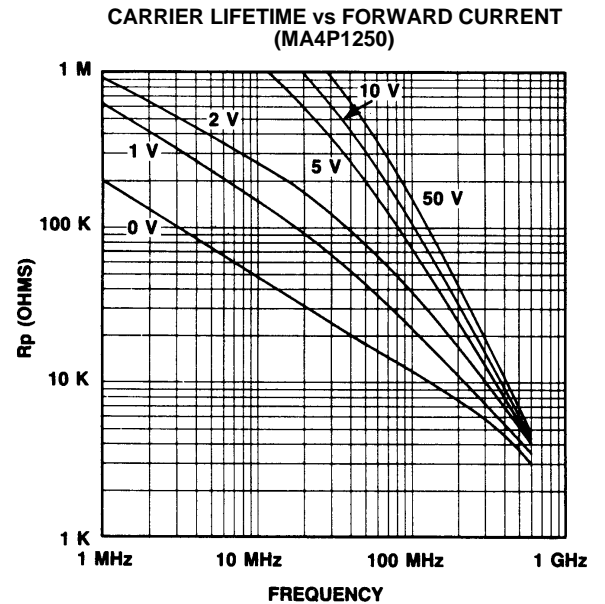
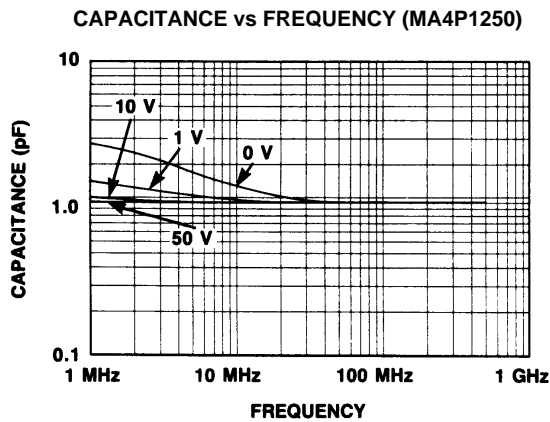

SERIES RESISTANCE AT 100 MHz vs FORWARD CURRENT (MA4P1250)

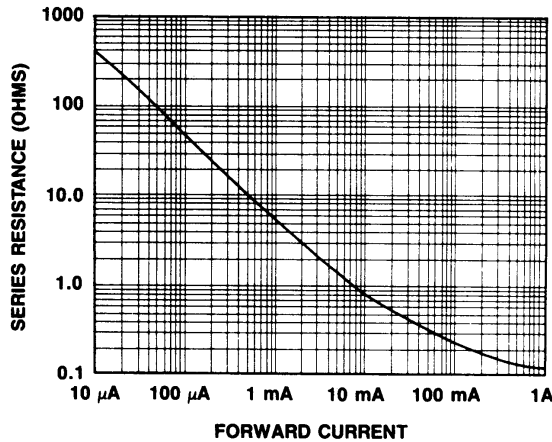

PARALLEL RESISTANCE vs FREQUENCY AND REVERSE BIAS (MA4P1250)

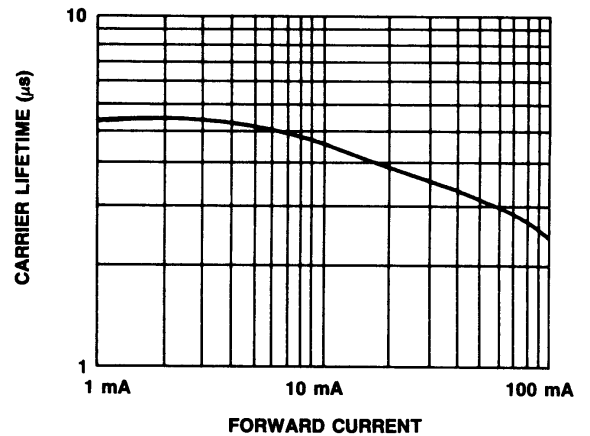

Specifications Subject to Change Without Notice.

MA4P1450 PIN Diodes for High Volume Applications
Electrical Specifications @ 25°C

Parameter	Minimum	Typical	Maximum	Unit	Condition
Series Resistance	—	0.5	0.75	Ohms	$I_F = 50 \text{ mA}$ $F = 100 \text{ MHz}$
Capacitance	—	1.8	2.5	pF	$F = 1 \text{ MHz}$ $V_R = 0$
Parallel Resistance	5 K	10 K	—	∅	$F = 100 \text{ MHz}$ $V_R = 0$
Carrier Lifetime	4	6	—	μS	$I_F = 10 \text{ mA}$
Forward Bias Harmonic Distortion (R_{2a} , R_{3a})	80	90	—	dBc	$F = 100 \text{ MHz}$ $P = 30 \text{ W}$ $I_F = 100 \text{ mA}$
Reverse Bias Harmonic Distortion (R_{2a} , R_{3a})	60	70	—	dBc	$F = 100 \text{ MHz}$ $P = 0 \text{ dBm}$ $V = 0 \text{ Volts}$
Voltage Rating	50	—	—	Volts	$I_V = 10 \text{ mA}$
Forward Voltage	1.0	—	—	—	100 mA
Thermal Resistance Junction Case $R_{TH(I-C)}$	—	12.5	15	°C/Watt	—

Note: Available only in case style 1091.

Absolute Maximum Ratings @ 25°C

Parameter	Absolute Maximum
Operating Temperature	-65°C to +175°C
Storage Temperature	-65°C to +175°C
DC Reverse Voltage	50 Volts
Power Dissipation	
Free Air	1.5 Watts
Contact Surfaces @ +25°C	4.0 Watts

Typical Performance Curves

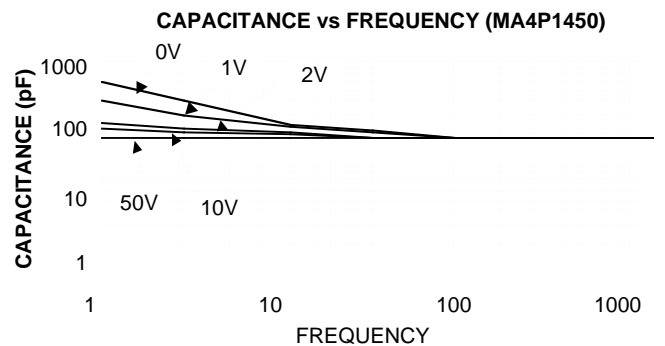
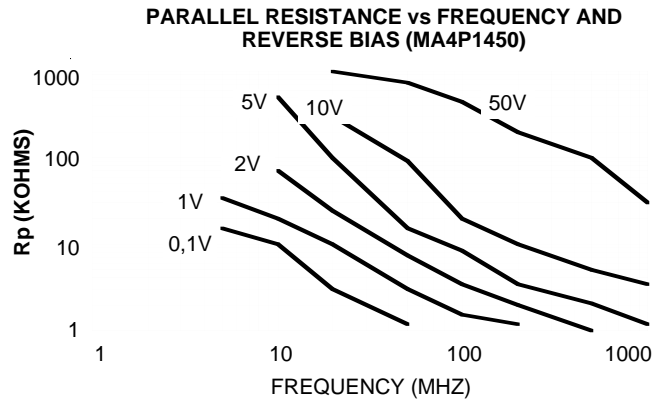
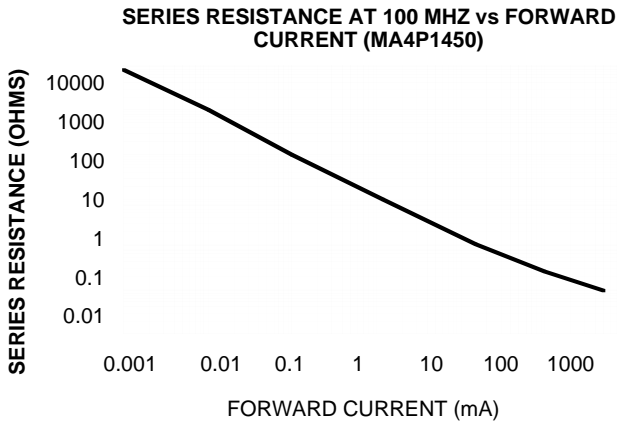

Specifications Subject to Change Without Notice.