



MAX1259 Battery Manager

MAX1259

General Description

The MAX1259 battery manager provides backup-battery switching for CMOS RAM, microprocessors, or other low-power logic ICs. It automatically switches to the backup battery when the primary power supply is interrupted. Low-loss switches guarantee an input-to-output differential of only 200mV while supplying 250mA from the primary power supply or 15mA from the battery.

Battery discharge during shipping does not occur in the MAX1259, since the backup battery can be disconnected by strobing the RST input.

A battery-fail output signal indicates when the backup battery is below +2V, and a power-fail output signal indicates when the primary power supply is low. The MAX1259 monitors the backup battery, warns of impending power failures, and switches the memory to the battery when failures occur. The MAX1259 is pin compatible with the DS1259, but consumes three times less supply current. Commercial, extended and military temperature range devices are available.

Applications

Battery Backup for CMOS RAM
 Uninterruptible Power Supplies
 Computers
 Controllers
 Automotive Systems

Functional Diagram

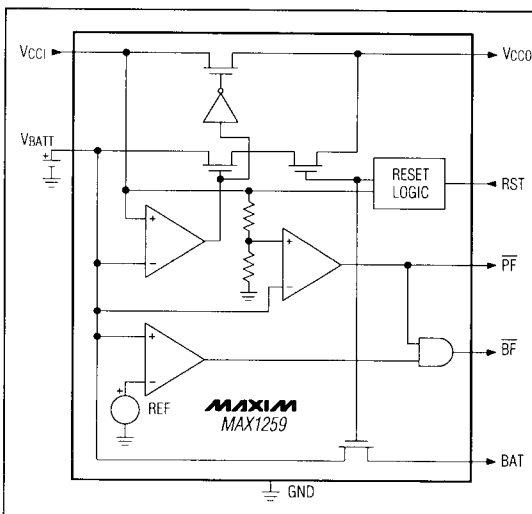

Features

- ◆ Switches to Backup Battery if Power Fails
- ◆ Consumes Less than 100nA of Battery Current
- ◆ Power-Fail Output Signals Primary Power-Supply Loss
- ◆ Battery Monitor Indicates Low Battery
- ◆ Battery Can Be Disconnected to Prevent Discharge During Shipping
- ◆ Battery Automatically Reconnected when Vcc is Applied
- ◆ Pin Compatible with the DS1259
- ◆ Supply Current Three Times Lower than DS1259
- ◆ Available in Extended-Industrial and Military Temperature Ranges

Ordering Information

PART	TEMP. RANGE	PIN-PACKAGE
MAX1259CPE	0°C to +70°C	16 Plastic DIP
MAX1259CWE	0°C to +70°C	16 Wide SO
MAX1259C/D	0°C to +70°C	Dice*
MAX1259EPE	-40°C to +85°C	16 Plastic DIP
MAX1259EWE	-40°C to +85°C	16 Wide SO
MAX1259MJE	-55°C to +125°C	16 CERDIP

* Contact factory for dice specifications.

Pin Configuration

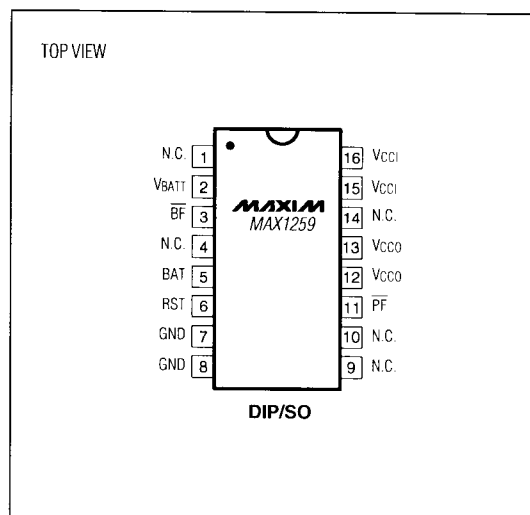

MAXIM

Maxim Integrated Products 1

Call toll free 1-800-998-8800 for free samples or literature.

MAX1259 Battery Manager

ABSOLUTE MAXIMUM RATINGS

Voltage to Any Pin Relative to GND -0.3V to +7.0V

Operating Temperature Ranges:

MAX1259C 0°C to +70°C

MAX1259E -40°C to +85°C

MAX1259MJE -55°C to +125°C

Storage Temperature Range -55°C to +125°C

Lead Temperature (soldering, 10 sec) +300°C

Stresses beyond those listed under "Absolute Maximum Ratings" may cause permanent damage to the device. These are stress ratings only, and functional operation of the device at these or any other conditions beyond those indicated in the operational sections of the specifications is not implied. Exposure to absolute maximum rating conditions for extended periods may affect device reliability.

RECOMMENDED DC OPERATING CONDITIONS

(All Grades, $T_A = T_{MIN}$ to T_{MAX} , unless otherwise noted.)

PARAMETER	SYMBOL	CONDITIONS	MIN	TYP	MAX	UNITS
Primary Power Supply (Note 1)	V _{CCI}			5.0	5.5	V
Input High Voltage (Note 1)	V _{IH}	MAX1259C	2.0		V _{CCI} + 0.3	V
		MAX1259E/M	2.4		V _{CCI} + 0.3	
Input Low Voltage (Note 1)	V _{IL}		-0.3		0.8	V
Battery Voltage (Note 2)	V _{BATT}	Pin 2	2.5	3.0	3.7	V
Battery Output (Note 1)	BAT	Pin 5	V _{BATT} - 0.1			V

DC ELECTRICAL CHARACTERISTICS

(V_{CC} = +4.5V to +5.5V, All Grades, $T_A = T_{MIN}$ to T_{MAX} , unless otherwise noted.)

PARAMETER	SYMBOL	CONDITIONS	MIN	TYP	MAX	UNITS
Leakage Current	I _{LO}		-1.0		1.0	μA
Output Current, PF, BF (Note 3)	I _{OH}	V _{OH} = 2.4V	-1.0			mA
Output Current, PF, BF	I _{OL}	V _{OL} = 0.4V			4.0	mA
Input Supply Current (Note 4)	I _{CCI}			2.00	3.33	mA
V _{CCO} Output Current	I _{CCO}	V _{CCO} = V _{CCI} - 0.2V Pins 12, 13			250	mA
Power-Fail Trip Point (Notes 2, 5)	V _{TP}	Pin 11	1.26 x V _{BATT} - 250mV	1.26 x V _{BATT}	1.26 x V _{BATT} + 250mV	V
Battery-Fail Trip Point (Note 6)	V _{BATTF}	Pin 3 (BF detect)		2.0		V

DC ELECTRICAL CHARACTERISTICS

(V_{CCI} < V_{BATT}, All Grades, $T_A = T_{MIN}$ to T_{MAX} , unless otherwise noted.)

PARAMETER	SYMBOL	CONDITIONS	MIN	TYP	MAX	UNITS
V _{CCO} Output Current (Note 7)	I _{CCO2}	V _{CCO} = V _{BATT} - 0.2V Pins 12, 13			15	mA
Battery Leakage (Note 8)	I _{BATT}	MAX1259C			100	nA
		MAX1259E			150	
		MAX1259M			10	μA
BAT Output Current (Note 9)	I _{BATOUT}	Pin 5			100	μA

MAX1259 Battery Manager

MAX1259

CAPACITANCE

(All Grades, $T_A = +25^\circ\text{C}$, unless otherwise noted.)

PARAMETER	SYMBOL	CONDITIONS	MIN	TYP	MAX	UNITS
Input Capacitance (Note 10)	C_{IN}			5	10	pF
Output Capacitance (Note 10)	C_{OUT}			5	10	pF

AC ELECTRICAL CHARACTERISTICS

($V_{CC} = 4.0\text{V}$ to 5.5V , All Grades, $T_A = T_{MIN}$ to T_{MAX} , unless otherwise noted.)

PARAMETER	SYMBOL	CONDITIONS	MIN	TYP	MAX	UNITS
V_{CCI} Fall Time	t_F		300			μs
V_{CCI} Rise Time	t_R		1			μs
Power Down to PF Low	t_{PF}		0			μs
PF High after Power Up	t_{REC}				100	μs
RST Pulse Width	RSTPW		50	10		ns

Note 1: All voltages referenced to ground.

Note 2: Trip-point voltage for Power-Fail Detect: $V_{TP} = 1.26 \times V_{BATT}$. For 5% operation: $V_{BATT} = 3.7\text{V}$ max.

Note 3: 50pF load capacity.

Note 4: Measured with pins 3, 11, 12, 13, and open.

Note 5: V_{TP} is the point at which PF is driven low.

Note 6: V_{BATT} is the point at which BF is driven low.

Note 7: I_{CCO2} may be limited by battery capacity.

Note 8: Battery leakage is the internal energy consumed by the MAX1259

Note 9: See *Typical Operating Characteristics, BAT Switch Drop vs. Battery Voltage*.

Note 10: Guaranteed by design. Not tested.

Pin Description

PIN	NAME	FUNCTION
1, 4, 9, 10, 14	N.C.	No Connect. Make no connections to these pins.
2	V_{BATT}	Backup Battery Input
3	BF	Battery-Fail Output. BF is high for V_{CCI} at or above V_{TP} and the backup battery greater than 2V. If the backup battery is below 2V or V_{CCI} falls below V_{TP} , BF will be driven low.
5	BAT	Battery Output. During normal operation, the BAT output supplies up to 1mA of continuous battery current. In shipping mode, the BAT output is high impedance.
6	RST	Battery-Disconnect Input. The RST input is used to prevent battery discharge during shipping. Pulsing the RST input disconnects the backup battery from the V_{CCO} and BAT outputs.
7, 8	GND	Ground
11	PF	Power-Fail Output. PF is high for V_{CCI} greater than $1.26 \times V_{BATT}$ (V_{TP}), indicating a valid V_{CCI} voltage.
12, 13	V_{CCO}	CMOS RAM is powered from V_{CCO} . The battery switchover circuit compares V_{CCI} to the V_{BATT} input, and connects V_{CCO} to whichever is higher.
15, 16	V_{CCI}	+5V V_{CC} Input

MAX1259 Battery Manager

Typical Operating Characteristics

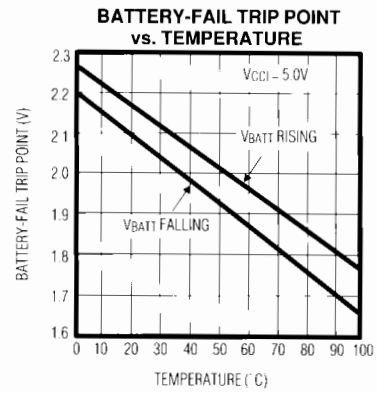
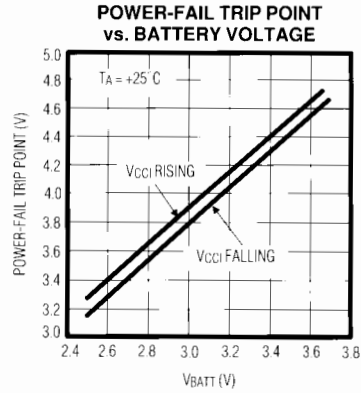
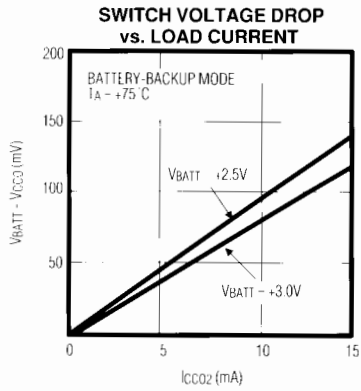
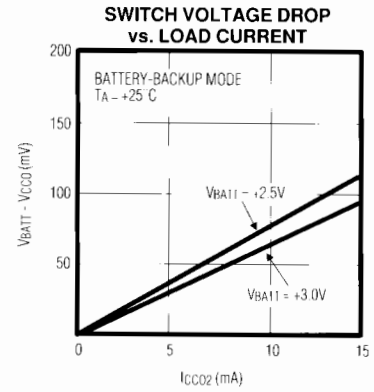
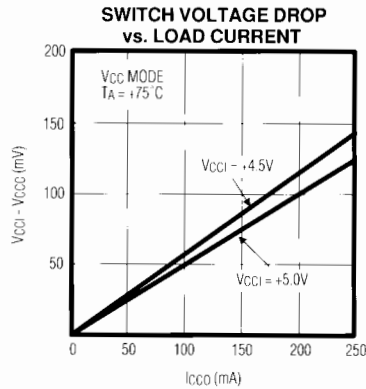
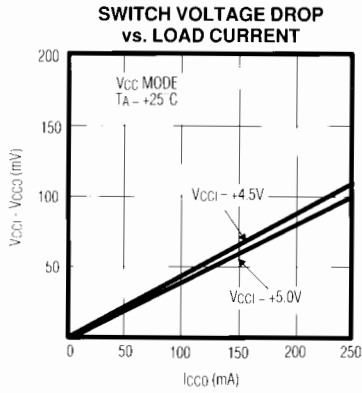

MAX1259 Battery Manager

Typical Operating Characteristics (continued)

MAX1259

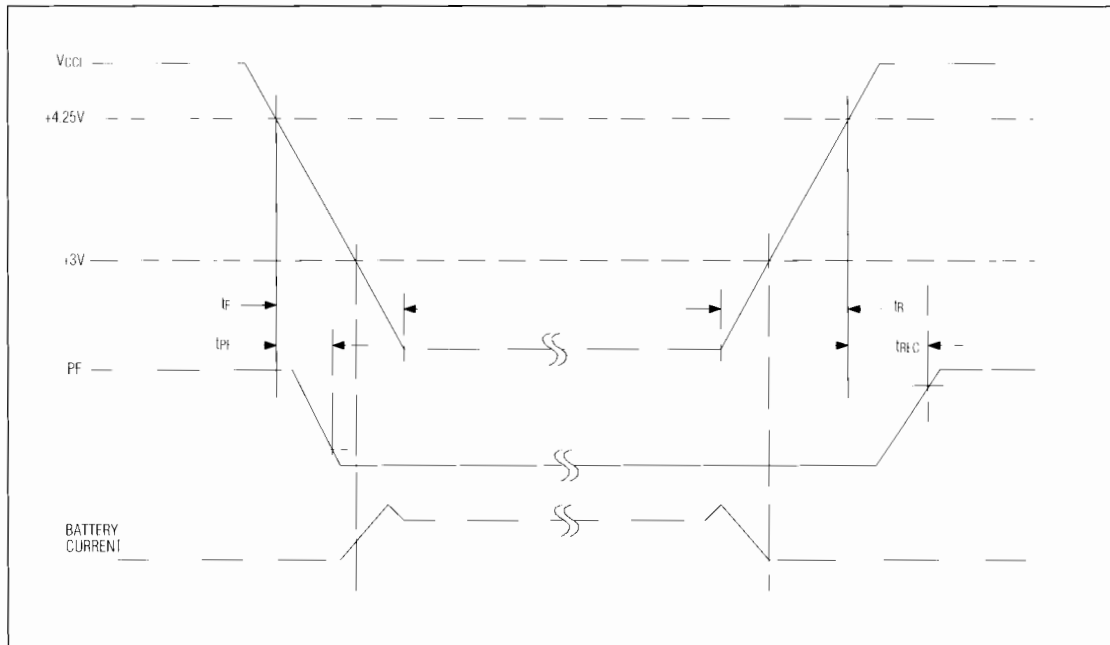
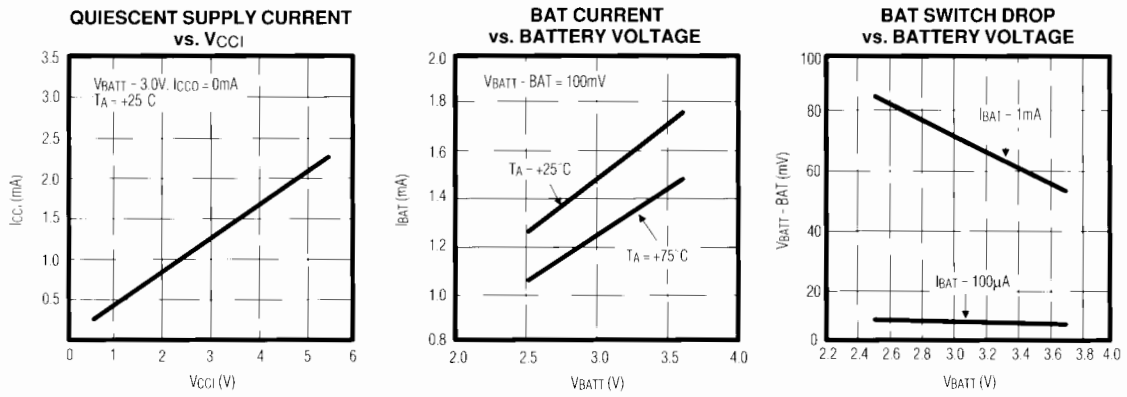

Figure 1. Power-Down/Power-Up Conditions

MAX1259 Battery Manager

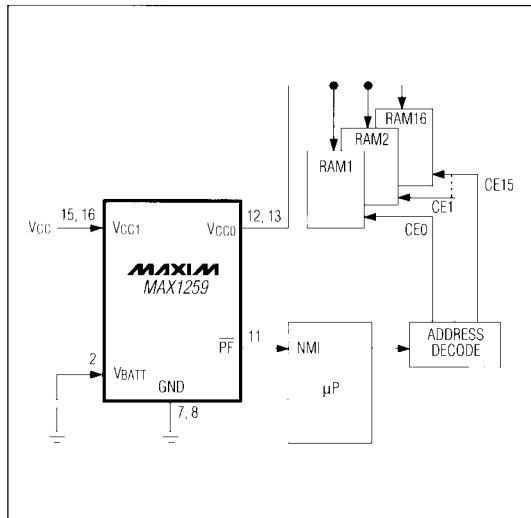
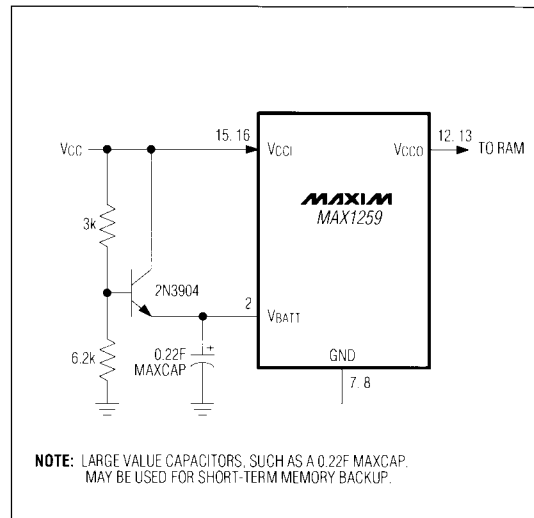

Figure 2. Typical Application Circuit



NOTE: LARGE VALUE CAPACITORS, SUCH AS A 0.22F MAXCAP, MAY BE USED FOR SHORT-TERM MEMORY BACKUP.

Figure 3. Using a MAXCAP as a Backup Battery

Detailed Description

Battery Switchover and V_{CC0}

Figure 2 shows a typical application for the MAX1259. CMOS RAM is powered from V_{CC0}. The battery switchover circuit compares V_{CC} to the V_{BATT} input, and connects V_{CC0} to whichever is higher.

Switchover occurs when V_{CC} equals V_{BATT} as V_{CC} falls, and when V_{CC} is 60mV greater than V_{BATT} as V_{CC} rises. This hysteresis prevents repeated, rapid switching if V_{CC} falls very slowly or remains nearly equal to the battery voltage. Low-loss switches guarantee an input-to-output differential of only 200mV, while supplying 250mA from the primary power supply or 15mA from the battery.

Note: With adequate filtering, the MAX1259 need only supply the average current drawn by the CMOS RAM. Many RAM data sheets specify a 75mA maximum supply current, but this peak current spike lasts only 100ns. If the sum of the peak currents is greater than 250mA, a capacitor placed on the V_{CC0} output can supply the high instantaneous current, while V_{CC0} need only supply the average current, which is much less.

The MAX1259 operates with battery voltages from 2.5V to 3.7V. High-value capacitors – either standard electrolytic or farad-sized, double-layer capacitors – can also be used for short-term memory backup (Figure 3).

To achieve rated performance, the V_{CC} input should be connected to both V_{CC1} pins (pins 15 and 16). As well, the switched output should be connected to both V_{CC0} pins (pins 12 and 13).

Power Fail

The Power-Fail (PF) Output is high for V_{CC1} greater than 1.26 x V_{BATT} (V_{TP}), indicating a valid V_{CC1} voltage.

Battery Fail

If V_{CC1} is at or above the voltage trip threshold (V_{TP}) and the backup battery is greater than 2V, the Battery-Fail (BF) Output will be held high, indicating a charged battery. If the backup battery drops below 2V or V_{CC1} falls below V_{TP}, BF will be driven low.

BAT Output

During normal operation, the BAT output stays at the battery voltage, regardless of the V_{CC1} level. This provides 1mA battery current.

RESET (Digitally Controlled Battery Disconnect)

To prevent battery discharge during shipping, the backup battery can be disconnected from V_{CC0} and BAT.

This disconnect feature is activated by pulsing the Reset (RST) Input high for a minimum of 50ns with V_{CC1} greater than V_{TP} (Figure 4). When primary power is removed, the V_{CC0} and BAT outputs will go high impedance. The next time primary power is applied with V_{CC1} greater than 1.26 x V_{BATT} (V_{TP}), normal operation resumes. Note that when the MAX1259 is first powered up, V_{CC1} must be brought above 1.26 x V_{BATT}. This resets an internal flip flop, ensuring that the part is in normal V_{CC} mode and not in shipping mode.

MAX1259 Battery Manager

MAX1259

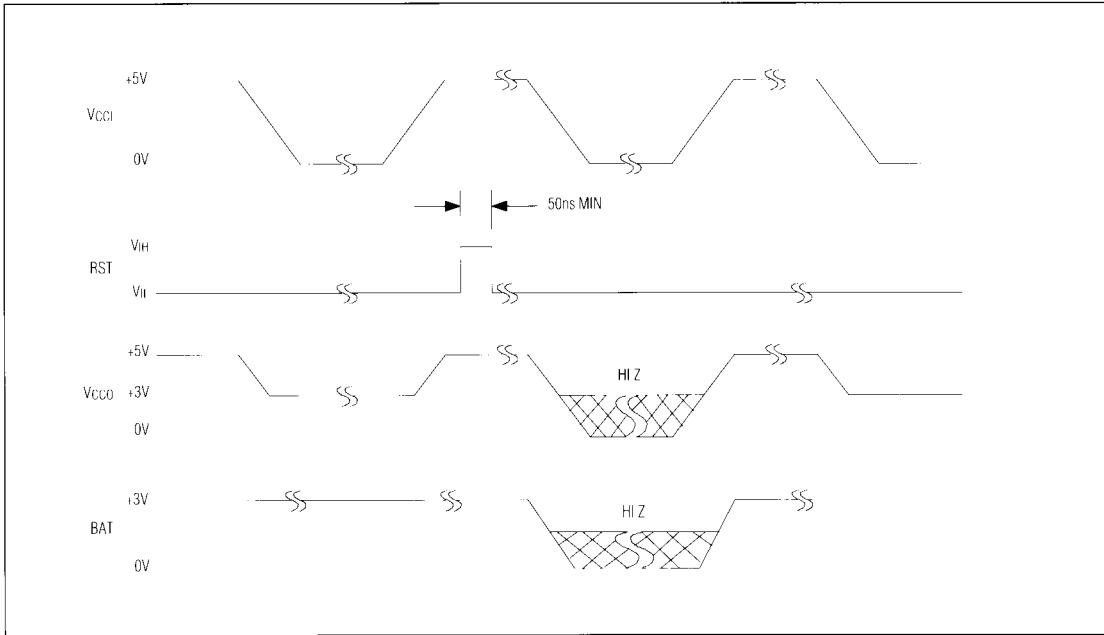

Figure 4. Reset Timing

Application Information

If a protection diode is placed in series with the backup battery, Pin 2 must be bypassed with at least a 0.01 μ F capacitor to ground.

MAX1259 Battery Manager

Chip Topography

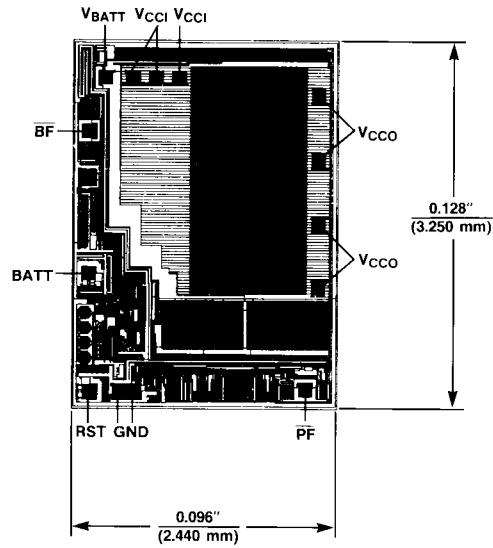

Maxim cannot assume responsibility for use of any circuitry other than circuitry entirely embodied in a Maxim product. No circuit patent licenses are implied. Maxim reserves the right to change the circuitry and specifications without notice at any time.

8 **Maxim Integrated Products, 120 San Gabriel Drive, Sunnyvale, CA 94086 (408) 737-7600**

© 1994 Maxim Integrated Products

Printed USA

MAXIM is a registered trademark of Maxim Integrated Products.