

MAXIM

24V, 600mA Internal Switch, 100% Duty Cycle, Step-Down Converter

MAX1776

General Description

The MAX1776 high-efficiency step-down converter provides an adjustable output voltage from 1.25V to V_{IN} from supply voltages as high as 24V. An internal current-limited 0.4Ω MOSFET delivers load currents up to 600mA. Operation to 100% duty cycle minimizes dropout voltage (240mV at 600mA).

The MAX1776 has a low 15 μ A quiescent current to improve light-load efficiency and conserve battery life. The device draws only 3 μ A while in shutdown.

High switching frequencies (up to 200kHz) allow the use of tiny surface-mount inductors and output capacitors. The MAX1776 is available in an 8-pin μ MAX package, which uses half the space of an 8-pin SO. For increased output drive capability, use the MAX1626/MAX1627 step-down controllers, which drive an external P-channel MOSFET to deliver up to 20W.

Features

- ◆ Fixed 5V or Adjustable Output
- ◆ 4.5V to 24V Input Voltage Range
- ◆ Up to 600mA Output Current
- ◆ Internal 0.4Ω P-Channel MOSFET
- ◆ Efficiency Over 95%
- ◆ 15 μ A Quiescent Supply Current
- ◆ 3 μ A Shutdown Current
- ◆ 100% Maximum Duty Cycle for Low Dropout
- ◆ Current-Limited Architecture
- ◆ Thermal Shutdown
- ◆ Small 8- μ MAX Package

Applications

Notebook Computers
Distributed Power Systems
Keep-Alive Supplies
Hand-Held Devices

Ordering Information

PART	TEMP RANGE	PIN-PACKAGE
MAX1776EUA	-40°C to +85°C	8 μ MAX

Typical Operating Circuit

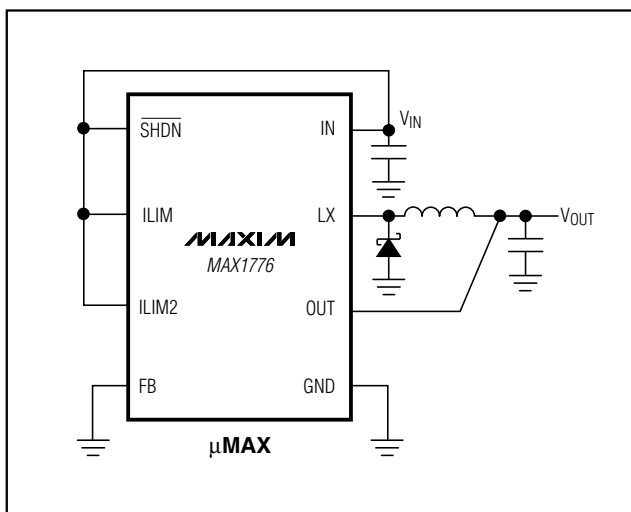

Pin Configuration

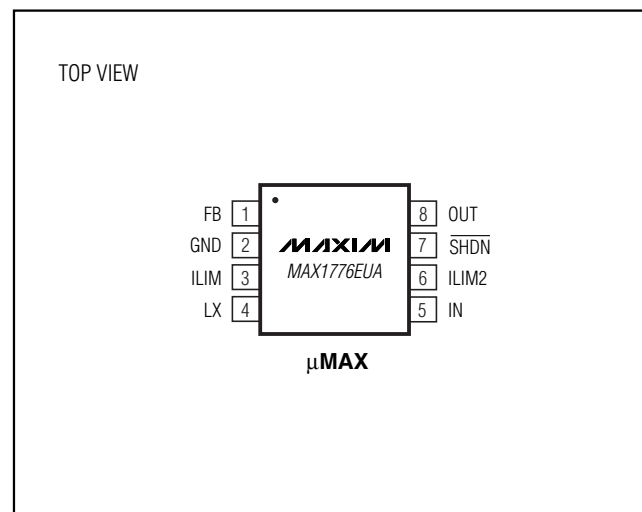
**MAXIM**

Maxim Integrated Products 1

For pricing, delivery, and ordering information, please contact Maxim/Dallas Direct! at 1-888-629-4642, or visit Maxim's website at www.maxim-ic.com.

24V, 600mA Internal Switch, 100% Duty Cycle, Step-Down Converter

ABSOLUTE MAXIMUM RATINGS

IN, $\overline{\text{SHDN}}$, ILIM, ILIM2 to GND-0.3V to 25V
 LX to GND-2V to ($V_{\text{IN}} + 0.3\text{V}$)
 OUT, FB to GND-0.3V to 6V
 Peak Input Current 2A
 Maximum DC Input Current 500mA

Continuous Power Dissipation ($T_A = +70^\circ\text{C}$)
 8-Pin μMAX (derate 4.1mW/ $^\circ\text{C}$ above $+70^\circ\text{C}$)330mW
 Operating Temperature Range-40 $^\circ\text{C}$ to +85 $^\circ\text{C}$
 Junction Temperature+150 $^\circ\text{C}$
 Storage Temperature Range-65 $^\circ\text{C}$ to +150 $^\circ\text{C}$
 Lead Temperature (soldering, 10s)+300 $^\circ\text{C}$

Stresses beyond those listed under "Absolute Maximum Ratings" may cause permanent damage to the device. These are stress ratings only, and functional operation of the device at these or any other conditions beyond those indicated in the operational sections of the specifications is not implied. Exposure to absolute maximum rating conditions for extended periods may affect device reliability.

ELECTRICAL CHARACTERISTICS

(Circuit of Figure 1, $V_{\text{IN}} = +12\text{V}$, $\overline{\text{SHDN}} = \text{IN}$, $T_A = 0^\circ\text{C}$ to +85 $^\circ\text{C}$, unless otherwise noted.)

PARAMETER	SYMBOL	CONDITIONS		MIN	TYP	MAX	UNITS
Input Voltage Range	V_{IN}			4.5		24	V
Input Supply Current	I_{IN}	No load			15	28	μA
Input Supply Current in Dropout	$I_{\text{IN(DROP)}}$	No load			50	70	μA
Input Shutdown Current		$\overline{\text{SHDN}} = \text{GND}$			3	7	μA
Input Undervoltage Lockout Threshold	V_{UVLO}	V_{IN} rising		3.6	4.0	4.4	V
		V_{IN} falling		3.5	3.9	4.3	
Output Voltage (Preset Mode)	V_{OUT}	FB = GND		4.80	5.00	5.20	V
Feedback Set Voltage (Adjustable Mode)	V_{FB}			1.212	1.25	1.288	V
OUT Bias Current		$V_{\text{OUT}} = 5.5\text{V}$		1.65	3.5	6.25	μA
OUT Pin Maximum Voltage						5.5	V
FB Bias Current	I_{FB}	$V_{\text{FB}} = 1.3\text{V}$		-25		+25	nA
FB Dual Mode™ Threshold Low				50	100	150	mV
LX Switch Minimum Off-Time	$t_{\text{OFF(MIN)}}$			0.22	0.42	0.62	μs
LX Switch Maximum On-Time	$t_{\text{ON(MAX)}}$	$V_{\text{FB}} = 1.3\text{V}$		8	10	12	μs
LX Switch On-Resistance	R_{LX}	$V_{\text{IN}} = 6\text{V}$	ILIM = ILIM2 = GND		1.6	3.2	Ω
			ILIM = GND, ILIM2 = IN		0.8	1.6	
			ILIM = IN, ILIM2 = GND		0.4	0.8	
			ILIM = ILIM2 = IN		0.4	0.8	
		$V_{\text{IN}} = 4.5\text{V}$	ILIM = ILIM2 = GND		1.9	3.8	
			ILIM = GND, ILIM2 = IN		1.0	1.9	
			ILIM = IN, ILIM2 = GND		0.5	0.95	
			ILIM = ILIM2 = IN		0.5	0.95	
LX Current Limit	$I_{\text{LX(PEAK)}}$	ILIM = ILIM2 = GND		120	150	180	mA
		ILIM = GND, ILIM2 = IN		240	300	360	
		ILIM = IN, ILIM2 = GND		480	600	720	
		ILIM = ILIM2 = IN		960	1200	1440	
LX Zero-Crossing Threshold				-75		+75	mV
Zero-Crossing Timeout		LX does not rise above the threshold			30		μs
LX Switch Leakage Current		$V_{\text{IN}} = 24\text{V}$, LX = GND	$T_A = +25^\circ\text{C}$			1	μA
			$T_A = 0^\circ\text{C}$ to +85 $^\circ\text{C}$			10	

Dual Mode is a trademark of Maxim Integrated Products, Inc.

24V, 600mA Internal Switch, 100% Duty Cycle, Step-Down Converter

MAX1776

ELECTRICAL CHARACTERISTICS (continued)

(Circuit of Figure 1, $V_{IN} = +12V$, $\overline{SHDN} = IN$, $T_A = 0^{\circ}C$ to $+85^{\circ}C$, unless otherwise noted.)

PARAMETER	SYMBOL	CONDITIONS	MIN	TYP	MAX	UNITS
Dropout Voltage	$V_{DROPOUT}$	$I_{OUT} = 525mA$, $I_{LIM} = I_{LIM2} = IN$		0.2		V
Line Regulation		$V_{IN} = 8V/24V$, 200 Ω load		0.1		%/V
Load Regulation		No load/full load		0.9		%
Digital Input Level		\overline{SHDN} , I_{LIM2}			0.8	V
		Low				
		High	2.4			
Digital Input Leakage Current		$V_{\overline{SHDN}}$, $V_{I_{LIM}}$, $V_{I_{LIM2}} = 0$ or 24V, $V_{IN} = 24V$	-1		+1	μA
ILIM Input Level		Low			0.05	V
		High	2.2			
Thermal Shutdown		10 $^{\circ}C$ hysteresis		160		$^{\circ}C$

ELECTRICAL CHARACTERISTICS

(Circuit of Figure 1, $V_{IN} = +12V$, $\overline{SHDN} = IN$, $T_A = -40^{\circ}C$ to $+85^{\circ}C$, unless otherwise noted.) (Note 1)

PARAMETER	SYMBOL	CONDITIONS	MIN	MAX	UNITS	
Input Voltage Range	V_{IN}		4.5	24	V	
Input Supply Current	I_{IN}	No load		28	μA	
Input Supply Current in Dropout	$I_{IN(DROP)}$	No load		70	μA	
Input Shutdown Current		$\overline{SHDN} = GND$		7	μA	
Input Undervoltage Lockout Threshold	V_{UVLO}	V_{IN} rising	3.6	4.4	V	
		V_{IN} falling	3.5	4.3		
Output Voltage (Preset Mode)	V_{OUT}	FB = GND	4.75	5.25	V	
Feedback Set Voltage (Adjustable Mode)	V_{FB}		1.2	1.3	V	
OUT Bias Current		$V_{OUT} = 5.5V$	1.65	6.25	μA	
OUT Pin Maximum Voltage				5.5	V	
FB Bias Current	I_{FB}	$V_{FB} = 1.3V$	-25	+25	nA	
FB Dual Mode Threshold Low			45	155	mV	
LX Switch Minimum Off-Time	$t_{OFF(MIN)}$		0.22	0.64	μs	
LX Switch Maximum On-Time	$t_{ON(MAX)}$	$V_{FB} = 1.3V$	7.5	12.5	μs	
LX Switch On-Resistance	R_{LX}	$V_{IN} = 6V$	ILIM = ILIM2 = GND		3.2	Ω
			ILIM = GND, ILIM2 = IN		1.6	
			ILIM = IN, ILIM2 = GND		0.8	
			ILIM = ILIM2 = IN		0.8	
		$V_{IN} = 4.5V$	ILIM = ILIM2 = GND		3.8	
			ILIM = GND, ILIM2 = IN		1.9	
			ILIM = IN, ILIM2 = GND		0.95	
			ILIM = ILIM2 = IN		0.95	
LX Current Limit	$I_{LX(PEAK)}$	ILIM = ILIM2 = GND	100	200	mA	
		ILIM = GND, ILIM2 = IN	200	400		
		ILIM = IN, ILIM2 = GND	400	800		
		ILIM = ILIM2 = IN	800	1600		

24V, 600mA Internal Switch, 100% Duty Cycle, Step-Down Converter

ELECTRICAL CHARACTERISTICS (continued)

(Circuit of Figure 1, $V_{IN} = +12V$, $\overline{SHDN} = IN$, $T_A = -40^\circ C$ to $+85^\circ C$, unless otherwise noted.) (Note 1)

PARAMETER	SYMBOL	CONDITIONS	MIN	MAX	UNITS
LX Zero-Crossing Threshold			-75	75	mV
LX Switch Leakage Current		$V_{IN} = 24V$, LX = GND		10	μA
Digital Input Level		\overline{SHDN} , ILIM2	Low	0.8	V
		High	2.4		
Digital Input Leakage Current		$V_{\overline{SHDN}}$, V_{ILIM} , $V_{ILIM2} = 0$ or $24V$, $V_{IN} = 24V$	-1	1	μA
ILIM Input Level		Low		0.05	V
		High	2.2		

Note 1: Specifications to $-40^\circ C$ are guaranteed by design, not production tested.

Typical Operating Characteristics

(Circuit of Figure 1, components from Table 3, $V_{IN} = +12V$, $\overline{SHDN} = IN$, $T_A = +25^\circ C$.)

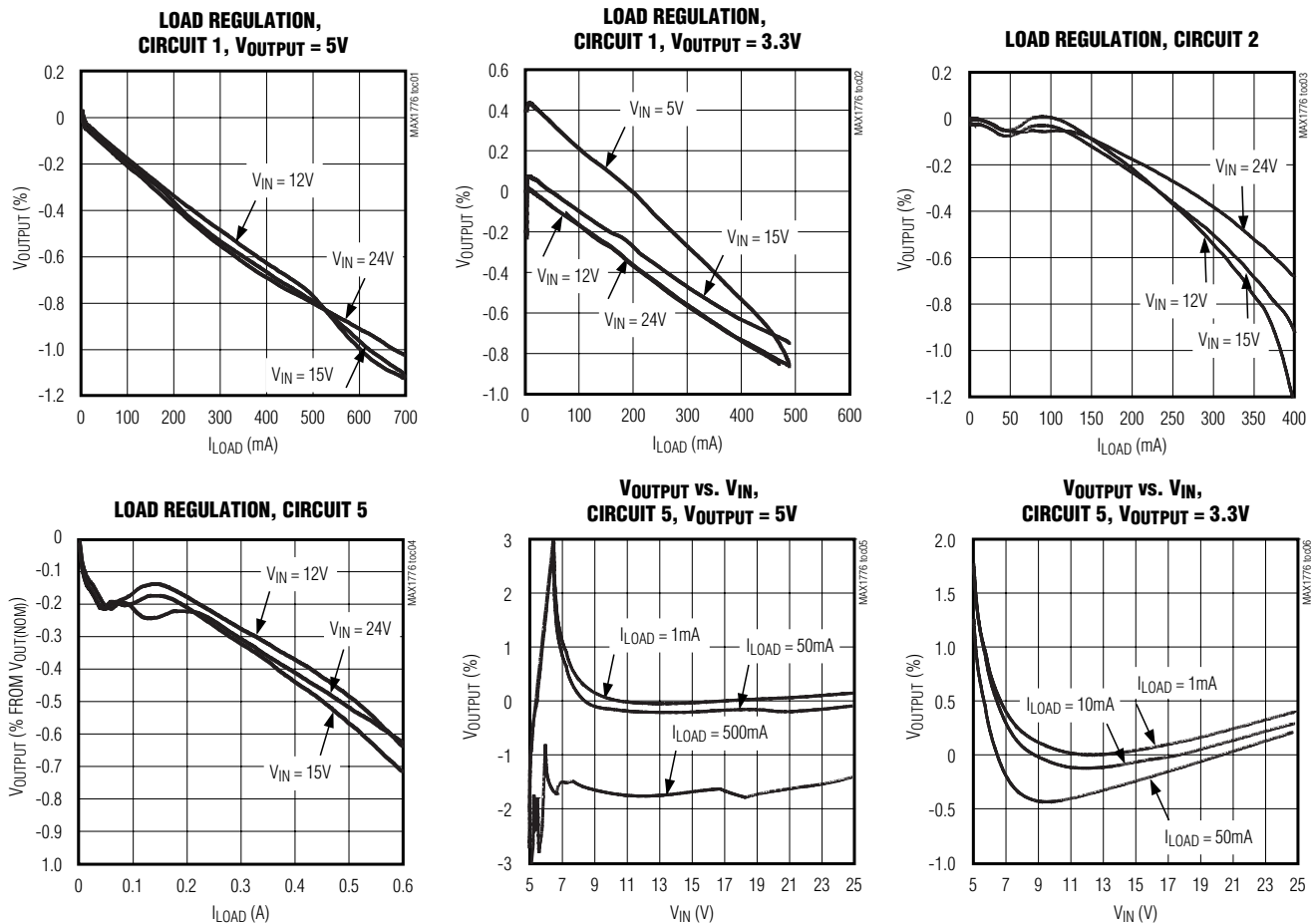

24V, 600mA Internal Switch, 100% Duty Cycle, Step-Down Converter

MAX1776

Typical Operating Characteristics (continued)

(Circuit of Figure 1, components from Table 3, $V_{IN} = +12V$, $SHDN = IN$, $T_A = +25^{\circ}C$.)

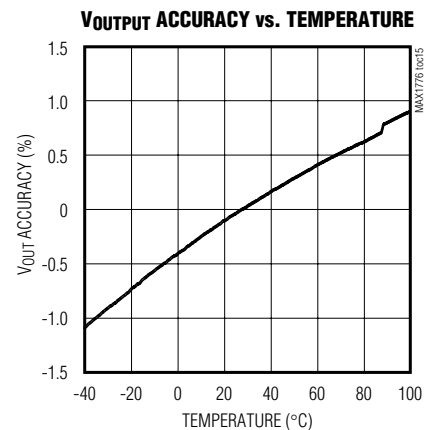
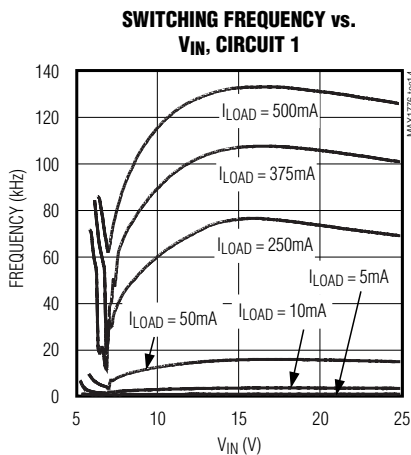
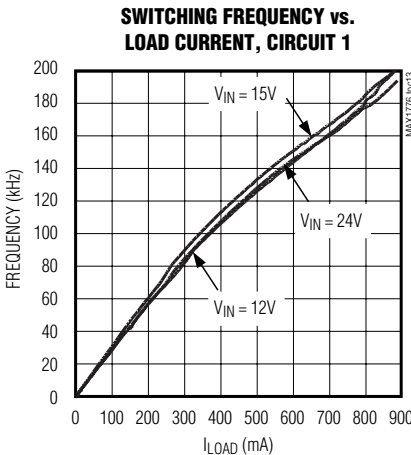
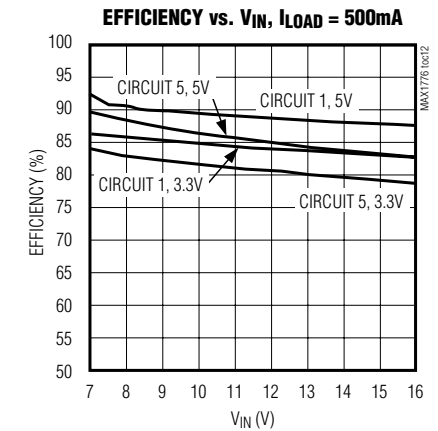
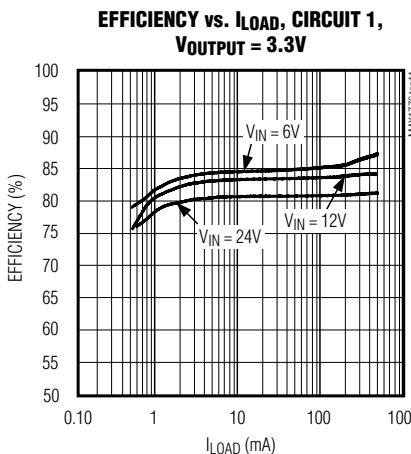
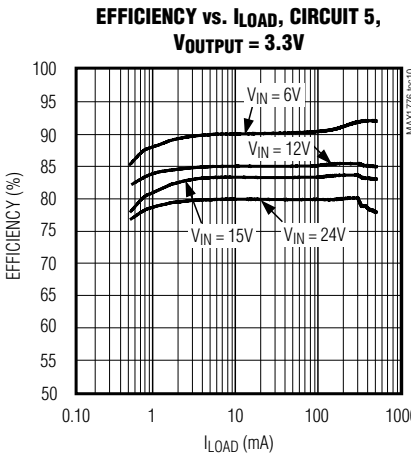
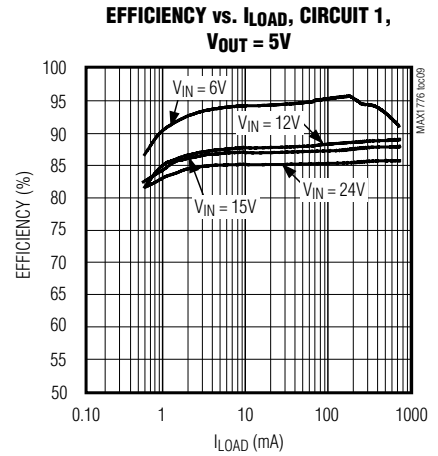
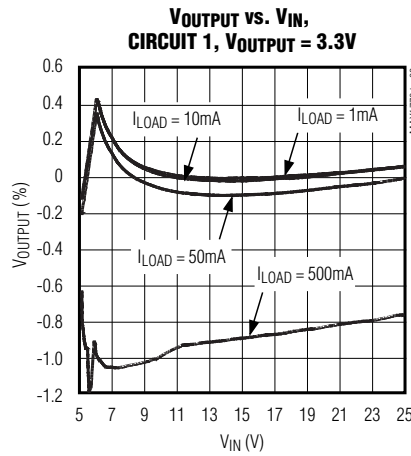
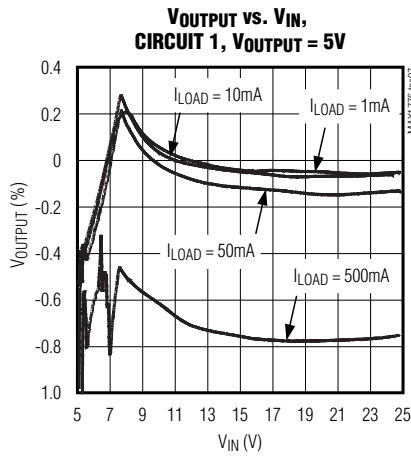

24V, 600mA Internal Switch, 100% Duty Cycle, Step-Down Converter

Typical Operating Characteristics (continued)

(Circuit of Figure 1, components from Table 3, $V_{IN} = +12V$, $\overline{SHDN} = IN$, $T_A = +25^\circ C$.)

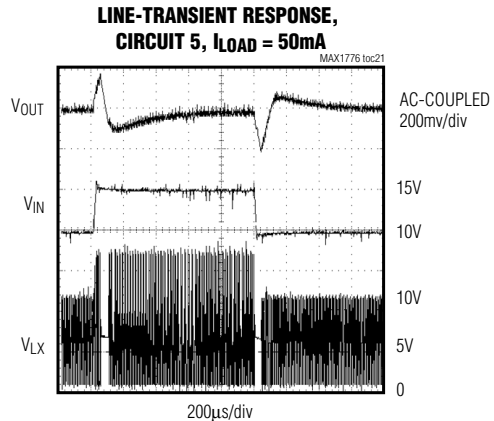
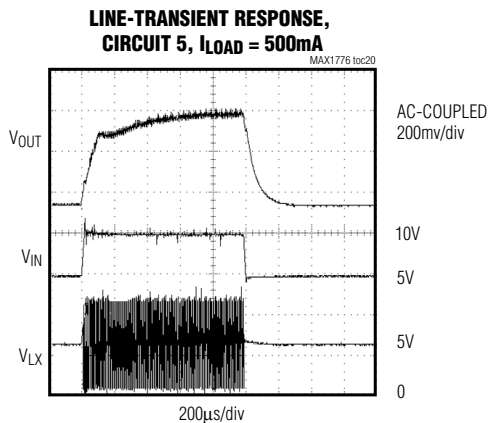
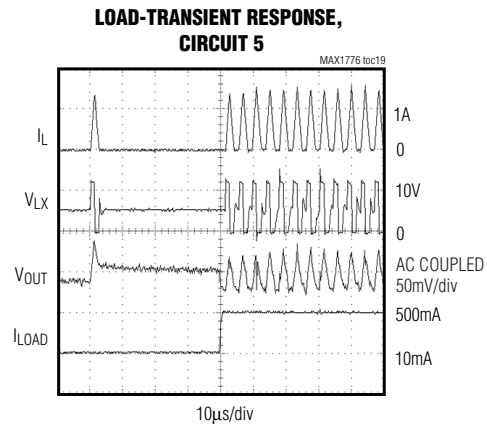
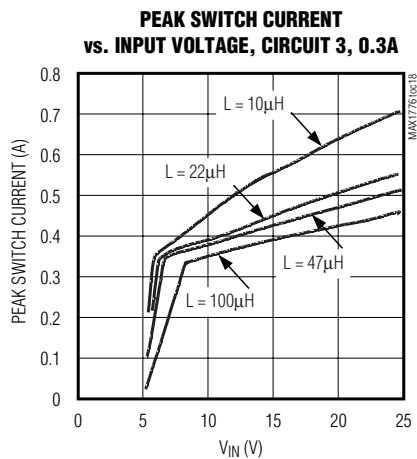
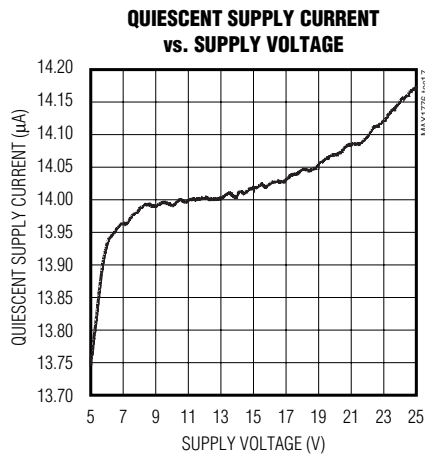
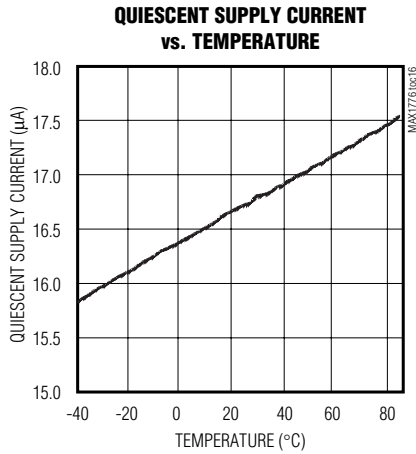

24V, 600mA Internal Switch, 100% Duty Cycle, Step-Down Converter

MAX1776

Typical Operating Characteristics (continued)

(Circuit of Figure 1, components from Table 3, $V_{IN} = +12V$, $\overline{SHDN} = IN$, $T_A = +25^\circ C$.)

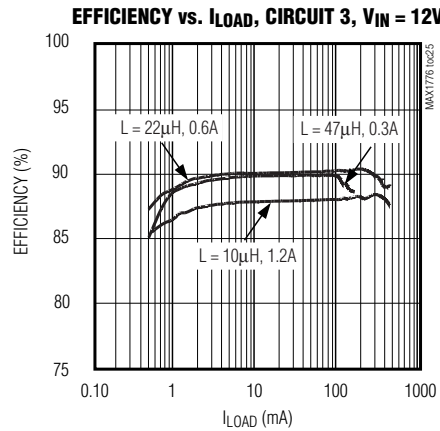
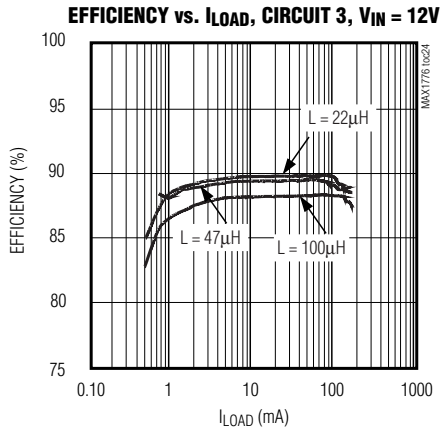
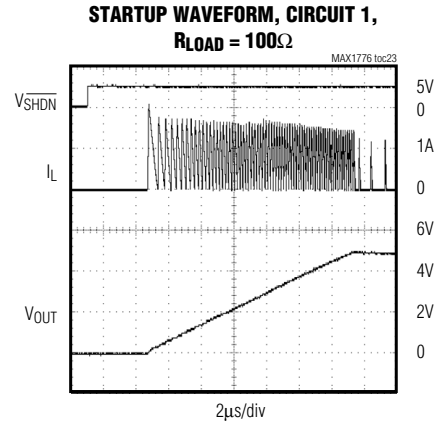
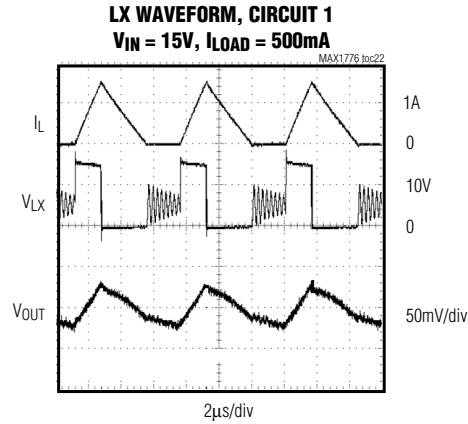

24V, 600mA Internal Switch, 100% Duty Cycle, Step-Down Converter

Pin Description

PIN	NAME	FUNCTION
1	FB	Dual-Mode Feedback Input. Connect to GND for the preset 5V output. Connect to a resistive divider between OUT and GND to adjust the output voltage between 1.25V and V_{IN} .
2	GND	Ground
3	ILIM	Peak Current Control Input. Connect to IN or GND to set peak current limit. ILIM and ILIM2 together set the peak current limit. See <i>Setting Current Limit</i> .
4	LX	Inductor Connection. Connect LX to external inductor and diode as shown in Figure 1.
5	IN	Input Supply Voltage. Input voltage range is 4.5V to 24V.
6	ILIM2	Peak Current Control Input 2. Connect to IN or GND. ILIM and ILIM2 together set the peak current limit. See <i>Setting Current Limit</i> .
7	$\overline{\text{SHDN}}$	Shutdown Input. A logic low shuts down the MAX1776 and reduces the supply current to 3 μ A. LX is high impedance in shutdown. Connect to IN for normal operation.
8	OUT	Regulated Output Voltage High-Impedance Sense Input. Internally connected to a resistive divider. Do not connect for output voltages higher than 5.5V. Connect to GND when not used.

Detailed Description

The MAX1776 step-down converter is designed primarily for battery-powered devices and notebook computers. The unique current-limited control scheme provides high efficiency over a wide load range. Operation up to 100% duty cycle allows the lowest possible dropout voltage, increasing the usable supply voltage range. Under no load, the MAX1776 draws only 15 μ A, and in shutdown mode, it draws only 3 μ A to further reduce power consumption and extend battery life. Additionally, an internal 24V switching MOSFET, internal current sensing, and a high switching frequency minimize PC board space and component costs.

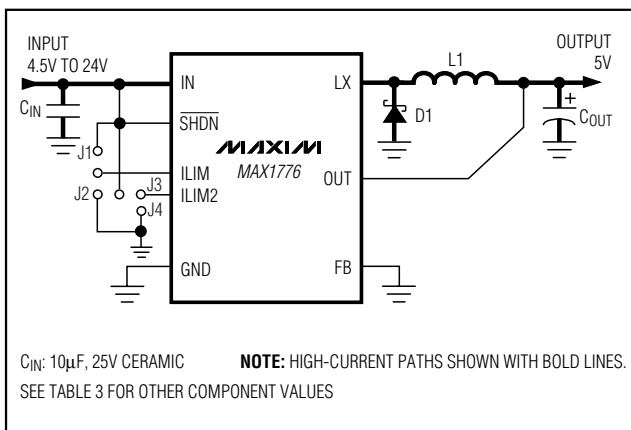

Figure 1. Typical Application Circuit

Current-Limited Control Architecture

The MAX1776 uses a proprietary current-limited control scheme with operation to 100% duty cycle. This DC-DC converter pulses as needed to maintain regulation, resulting in a variable switching frequency that increases with the load. This eliminates the high supply currents associated with conventional constant-frequency pulse-width-modulation (PWM) controllers that switch the MOSFET unnecessarily.

When the output voltage is too low, the error comparator sets a flip-flop, which turns on the internal P-channel MOSFET and begins a switching cycle (Figure 2). As shown in Figure 3, the inductor current ramps up linearly, storing energy in a magnetic field while charging the output capacitor and servicing the load. The MOSFET turns off when the peak current limit is reached, or when the maximum on-time of 10 μ s is exceeded and the output voltage is in regulation. If the output is out of regulation and the peak current is never obtained, the MOSFET remains on, allowing a duty cycle up to 100%. This feature ensures the lowest possible dropout voltage. Once the MOSFET turns off, the flip-flop resets, the inductor current is pulled through D1, and the current through the inductor ramps back down, transferring the stored energy to the output capacitor and load. The MOSFET remains off until the 0.42 μ s minimum off-time expires, and the output voltage drops out of regulation.

24V, 600mA Internal Switch, 100% Duty Cycle, Step-Down Converter

MAX1776

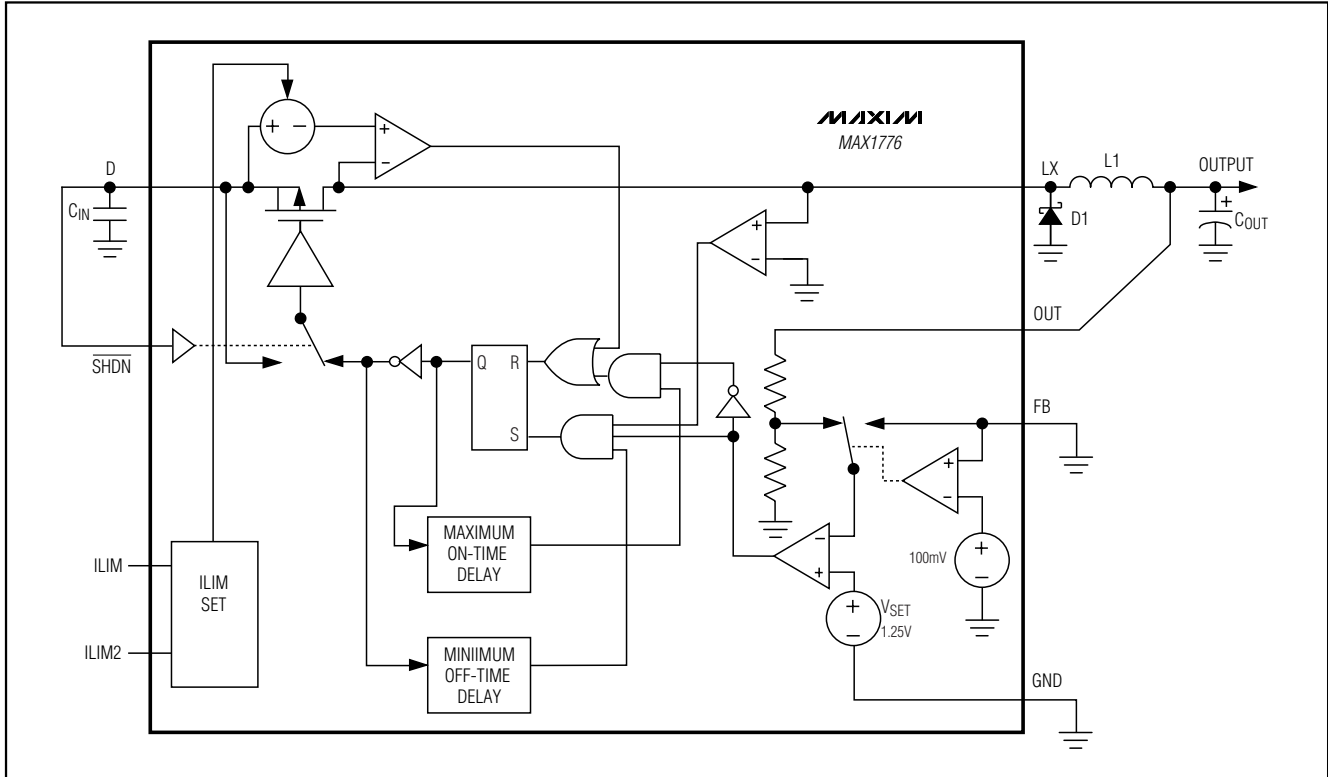

Figure 2. Simplified Functional Diagram

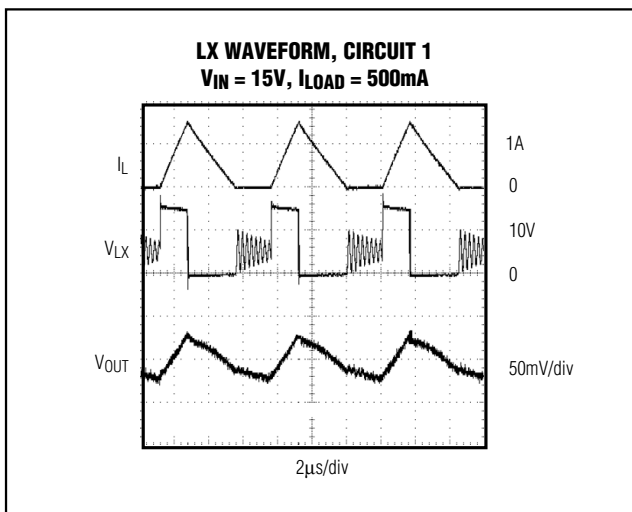

Figure 3. Discontinuous-Conduction Operation

Input-Output (Dropout) Voltage

A step-down converter's minimum input-to-output voltage differential (dropout voltage) determines the lowest usable supply voltage. In battery-powered systems, this limits the useful end-of-life battery voltage. To maximize battery life, the MAX1776 operates with duty cycles up to 100%, which minimizes the dropout voltage and eliminates switching losses while in dropout. When the supply voltage approaches the output voltage, the P-channel MOSFET remains on continuously to supply the load.

Dropout voltage is defined as the difference between the input and output voltages when the input is low enough for the output to drop out of regulation. For a step-down converter with 100% duty cycle, dropout depends on the MOSFET drain-to-source on-resistance and inductor series resistance; therefore, it is proportional to the load current:

$$V_{\text{DROPOUT}} = I_{\text{OUT}} \times (R_{\text{DS(ON)}} + R_{\text{INDUCTOR}})$$

24V, 600mA Internal Switch, 100% Duty Cycle, Step-Down Converter

Shutdown ($\overline{\text{SHDN}}$)

A logic low level on $\overline{\text{SHDN}}$ shuts down the MAX1776 converter. When in shutdown, the supply current drops to 3 μ A to maximize battery life, and the internal P-channel MOSFET turns off to isolate the output from the input. The output capacitance and load current determine the rate at which the output voltage decays. A logic level high on SHDN activates the MAX1776. Do not leave SHDN floating. If unused, connect SHDN to IN.

Thermal-Overload Protection

Thermal-overload protection limits total power dissipation in the MAX1776. When the junction temperature exceeds $T_J = +160^\circ\text{C}$, a thermal sensor turns off the pass transistor, allowing the IC to cool. The thermal sensor turns the pass transistor on again after the IC's junction temperature cools by 10°C , resulting in a pulsed output during continuous thermal-overload conditions.

Design Information

Output Voltage Selection

The feedback input features dual-mode operation. Connect FB to GND for the 5.0V preset output voltage. Alternatively, adjust the output voltage by connecting a voltage-divider from the output to GND (Figure 4). Select a value for R2 between 10k Ω and 100k Ω . Calculate R1 with the following equation:

$$R1 = R2 \times \left[\left(\frac{V_{\text{OUTPUT}}}{V_{\text{FB}}} \right) - 1 \right]$$

where $V_{\text{FB}} = 1.25\text{V}$, and V_{OUTPUT} may range from 1.25V to V_{IN} .

Setting Current Limit

The MAX1776 has an adjustable peak current limit. Configure this peak current limit by connecting ILIM and ILIM2 as shown in Table 1.

Table 1. Current-Limit Configuration

CURRENT LIMIT (mA)	ILIM CONNECTED TO	ILIM2 CONNECTED TO
150	GND	GND
300	GND	IN
600	IN	GND
1200	IN	IN

Choose a current limit that realistically reflects the maximum load current. The maximum output current is half of the peak current limit. Although choosing a lower current limit allows using an inductor with a lower current rating, it requires a higher inductance (see *Inductor Selection*) and does little to reduce inductor package size.

Inductor Selection

When selecting the inductor, consider these four parameters: inductance value, saturation rating, series resistance, and size. The MAX1776 operates with a wide range of inductance values. For most applications, values between 10 μ H and 100 μ H work best with the controller's high switching frequency. Larger inductor values will reduce the switching frequency and thereby improve efficiency and EMI. The trade-off for improved efficiency is a higher output ripple and slower transient response. On the other hand, low-value inductors respond faster to transients, improve output ripple, offer smaller physical size, and minimize cost. If the inductor value is too small, the peak inductor current exceeds the current limit due to current-sense comparator propagation delay, potentially exceeding the inductor's current rating. Calculate the minimum inductance value as follows:

$$L_{(\text{MIN})} = \frac{(V_{\text{IN}(\text{MAX})} - V_{\text{OUTPUT}}) \times t_{\text{ON}(\text{MIN})}}{I_{\text{LX}(\text{PEAK})}}$$

where $t_{\text{ON}(\text{MIN})} = 1\mu\text{s}$.

The inductor's saturation current rating must be greater than the peak switch current limit, plus the overshoot due to the 250ns current-sense comparator propagation delay. Saturation occurs when the inductor's magnetic flux density reaches the maximum level the core can support and the inductance starts to fall. Choose an inductor with a saturation rating greater than I_{PEAK} in the following equation:

$$I_{\text{PEAK}} = I_{\text{LX}(\text{PEAK})} + (V_{\text{IN}} - V_{\text{OUTPUT}}) \times 250\text{ns} / L$$

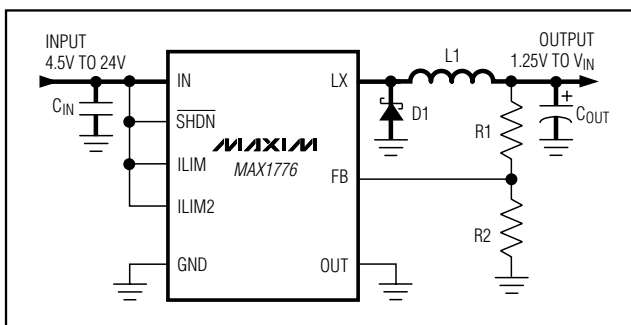

Figure 4. Adjustable Output Voltage

24V, 600mA Internal Switch, 100% Duty Cycle, Step-Down Converter

Inductor series resistance affects both efficiency and dropout voltage (see *Input-Output (Dropout) Voltage*). High series resistance limits the maximum current available at lower input voltages, and increases the dropout voltage. For optimum performance, select an inductor with the lowest possible DC resistance that fits in the allotted dimensions. Some recommended component manufacturers are listed in Table 2.

Maximum Output Current

The MAX1776 converter's output current determines the regulator's switching frequency. When the converter approaches continuous mode, the output voltage falls out of regulation. For the typical application, the maximum output current is approximately:

$$I_{LOAD(MAX)} = 1/2 I_{LX(PEAK)(MIN)}$$

For low-input voltages, the maximum on-time may be reached and the load current is limited by:

$$I_{LOAD} = 1/2 (V_{IN} - V_{OUT}) \times 10\mu s / L$$

Output Capacitor

Choose the output capacitor to service the maximum load current with acceptable voltage ripple. The output ripple has two components: variations in the charge stored in the output capacitor with each LX pulse, and the voltage drop across the capacitor's equivalent series resistance (ESR) caused by the current into and out of the capacitor:

$$V_{RIPPLE} \cong V_{RIPPLE(ESR)} + V_{RIPPLE(C)}$$

The output voltage ripple as a consequence of the ESR and output capacitance is:

$$V_{RIPPLE(ESR)} = ESR \times I_{PEAK}$$

$$V_{RIPPLE(C)} = \frac{L \times (I_{PEAK} - I_{OUTPUT})^2}{2C_{OUT} \times V_{OUTPUT}} \left(\frac{V_{IN}}{V_{IN} - V_{OUTPUT}} \right)$$

where I_{PEAK} is the peak inductor current (see *Inductor Selection*). The worst-case ripple occurs at no-load. These equations are suitable for initial capacitor selection, but final values should be set by testing a prototype or evaluation circuit. As a general rule, a smaller amount of charge delivered in each pulse results in less output ripple. Since the amount of charge delivered in each oscillator pulse is determined by the inductor value and input voltage, the voltage ripple increases with larger inductance, and as the input voltage decreases. See Table 3 for recommended capacitor values and Table 2 for recommended component manufacturers.

Input Capacitor

The input filter capacitor reduces peak currents drawn from the power source and reduces noise and voltage ripple on the input caused by the circuit's switching. The input capacitor must meet the ripple-current requirement (I_{RMS}) imposed by the switching current defined by the following equation:

$$I_{RMS} = \frac{I_{LOAD} V_{OUTPUT}}{V_{IN}} \sqrt{\left(\frac{4}{3} \times \frac{V_{IN}}{V_{OUTPUT}} - 1 \right)}$$

For most applications, nontantalum chemistries (ceramic, aluminum, polymer, or OS-CON) are preferred due to their robustness to high inrush currents typical of systems with low-impedance battery inputs. Alternatively, connect two (or more) smaller value low-ESR capacitors in parallel to reduce cost. Choose an input capacitor that exhibits less than +10°C temperature rise at the RMS input current for optimal circuit longevity.

Table 2. Component Suppliers

SUPPLIER	WEBSITE
DIODES	
Central Semiconductor	www.centralsemi.com
Fairchild	www.fairchildsemi.com
General Semiconductor	www.gensemi.com
International Rectifier	www.irf.com
Nihon	www.niec.co.jp/engver2/niec.co.jp_eg.htm
On Semi	www.onsemi.com
Vishay-Siliconix	www.vishay.com/brands/siliconix/main.html
Zetex	www.zetex.com
CAPACITORS	
AVX	www.avxcorp.com
Kemet	www.kemet.com
Nichicon	www.nichicon-us.com
Sanyo	www.sanyo.com
Taiyo Yuden	www.t-yuden.com
INDUCTORS	
Coilcraft	www.coilcraft.com
Coiltronics	www.cooperet.com
Pulse Engineering	www.pulseeng.com
Sumida USA	www.sumida.com
Toko	www.tokoam.com

24V, 600mA Internal Switch, 100% Duty Cycle, Step-Down Converter

Table 3. Recommended Components

CIRCUIT	INPUT VOLTAGE (V)	MAXIMUM LOAD CURRENT (mA)	I _{LX} (PEAK) CURRENT (A)	INDUCTOR	CAPACITOR
1	10 to 24	600	1.20	10μH, 1.56A, 70mΩ Toko D75F 646FY-100M, 10μH, 1.70A, 48mΩ Sumida CDRH6D28-100NC, or 10μH, 1.63A, 55mΩ Toko D75C 646CY-100M 0.055	100μF, 6.3V Sanyo POSCAP 6TPC100M
2	10 to 24	300	0.60	22μH, 1.17A, 120mΩ Toko D75F 646FY-220M, 22μH, 1.09A, 115mΩ Toko D75C 646CY-220M, or 22μH, 1.20A, 95mΩ Sumida CDRH6D28-220NC	47μF, 6.3V Sanyo POSCAP 6TPA47M
3	10 to 24	150	0.30	47μH, 0.54A, 440mΩ Sumida CDRH5D18-470	22μF, 6.3V, 1210 case Taiyo Youden JMK325BJ226MM
4	10 to 24	75	0.15	100μH, 0.29A, 766mΩ Sumida CDRH4D28-101	10μF, 6.3V, X7R, 1206 case Taiyo Youden JMK316BJ106ML
5	5 to 15	600	1.20	5.4μH, 1.6A, 56mΩ Sumida CDRH5D18-5R4	100μF, 6.3V Sanyo POSCAP 6TPC100m
6	5 to 15	300	0.60	10μH, 1.04A, 80mΩ Toko D73LC 817CY-100M	47μF, 6.3V Sanyo POSCAP 6TPA47M
7	5 to 15	150	0.30	22μH, 0.41A, 294mΩ Sumida CDRH4D18-220	22μF, 6.3V, 1210 case Taiyo Youden JMK325BJ226MM
8	5 to 15	75	0.15	47μH, 0.33A, 230mΩ Coilcraft DS1608C-473	10μF, 6.3V, X7R, 1206 case Taiyo Youden JMK316BJ106ML

Diode Selection

The current in the external diode (D1 in Figure 1) changes abruptly from zero to its peak value each time the LX switch turns off. To avoid excessive losses, the diode must have a fast turn-on time and a low forward voltage.

Make sure that the diode's peak current rating exceeds the peak current limit set by the current limit, and that its breakdown voltage exceeds V_{IN} . Use Schottky diodes when possible.

MAX1776 Stability

Instability is frequently caused by excessive noise on OUT, FB, or GND due to poor layout or improper component selection. Instability typically manifests itself as "motorboating," which is characterized by grouped switching pulses with large gaps and excessive low-frequency output ripple during no-load or light-load conditions.

PC Board Layout and Grounding

High switching frequencies and large peak currents make PC board layout an important part of the design. Poor layout introduces switching noise into the feedback path, resulting in jitter, instability, or degraded performance. High-power traces, highlighted in the

24V, 600mA Internal Switch, 100% Duty Cycle, Step-Down Converter

MAX1776

Typical Application Circuit (Figure 1), should be as short and wide as possible. Additionally, the current loops formed by the power components (CIN, COUT, L1, and D1) should be as short as possible to avoid radiated noise. Connect the ground pins of these power components at a common node in a star-ground configuration. Separate the noisy traces, such as the LX node, from the feedback network with grounded copper. Furthermore, keep the extra copper on the

board and integrate it into a pseudo-ground plane. When using external feedback, place the resistors as close to the feedback pin as possible to minimize noise coupling.

Chip Information

TRANSISTOR COUNT: 932

PROCESS: BiCMOS

Package Information

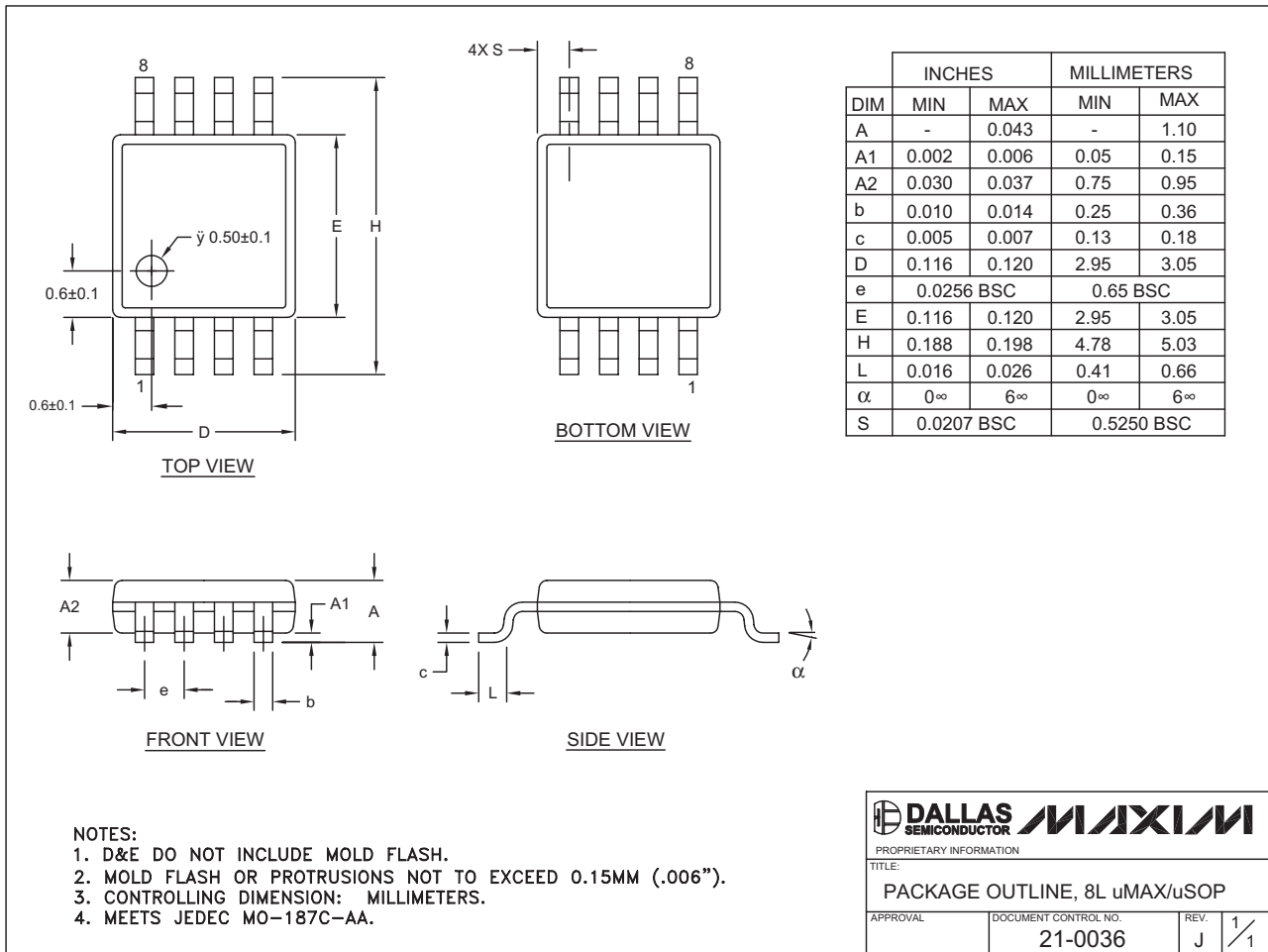

8LUMAXD.EPS

Maxim cannot assume responsibility for use of any circuitry other than circuitry entirely embodied in a Maxim product. No circuit patent licenses are implied. Maxim reserves the right to change the circuitry and specifications without notice at any time.

Maxim Integrated Products, 120 San Gabriel Drive, Sunnyvale, CA 94086 408-737-7600 13