

# LNAs with Step Attenuator and VGA

## General Description

The MAX2371/MAX2373 wideband low-noise amplifier (LNA) ICs are designed for direct conversion receiver (DCR) or very low intermediate frequency (VLIF) receiver applications. They contain single-channel, single-ended LNAs with switchable attenuator and automatic gain control (AGC) intended as a low-noise gain stage. These devices provide high gain-control range (typically 60dB) at radio frequency (RF) with excellent noise and reverse isolation characteristics.

The MAX2371/MAX2373 can work over the frequency range from 100MHz to 1GHz. In practice, only a narrow band is needed in each application, so different matching circuits can be applied. The devices are dynamically configured through the digital/analog control pins to select either maximum gain and low noise figure or power-saving mode. In addition, the MAX2371/MAX2373 feature high/low-current modes, high/low attenuation modes, linearly controlled gain states, and shutdown mode.

## Applications

Direct Conversion Receiver (DCR)  
Very Low IF Receiver

## Features

- ◆ Low Noise Figure (1.8dB typical)
- ◆ High Small-Signal Gain (15dB Nominal)
- ◆ Wide Frequency Range of Operation (100MHz to 1GHz)
- ◆ 20dB Step Attenuator
- ◆ 45dB AGC Range Excluding Step Attenuator
- ◆ 2.65V to 3.3V Single-Supply Operation
- ◆ Shutdown Mode
- ◆ 3.5mA Supply Current, Adjustable Down to 2.5mA
- ◆ 40dB Reverse Isolation

## Ordering Information

| PART        | TEMP RANGE     | PIN-PACKAGE | PKG CODE |
|-------------|----------------|-------------|----------|
| MAX2371EGC  | -40°C to +85°C | 12 QFN-EP*  | G1233-1  |
| MAX2371ETC  | -40°C to +85°C | 12 TQFN-EP* | T1233-3  |
| MAX2371ETC+ | -40°C to +85°C | 12 TQFN-EP* | T1233+3  |
| MAX2373EGC  | -40°C to +85°C | 12 QFN-EP*  | G1233-1  |
| MAX2373ETC  | -40°C to +85°C | 12 TQFN-EP* | T1233-3  |
| MAX2373ETC+ | -40°C to +85°C | 12 TQFN-EP* | T1233+3  |

\*EP = Exposed pad.

+Denotes lead-free package.

## Pin Configuration

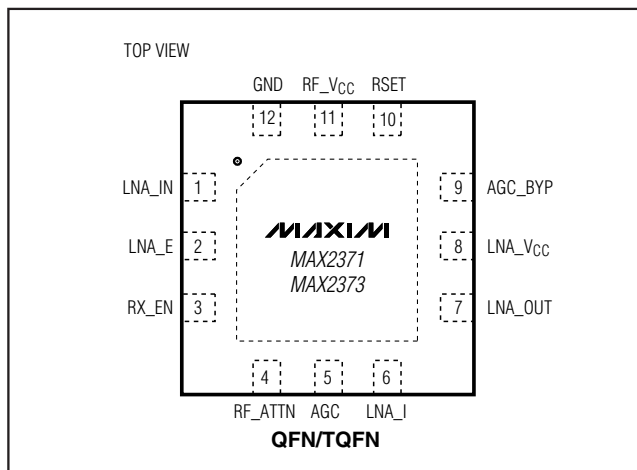

## Functional Diagram

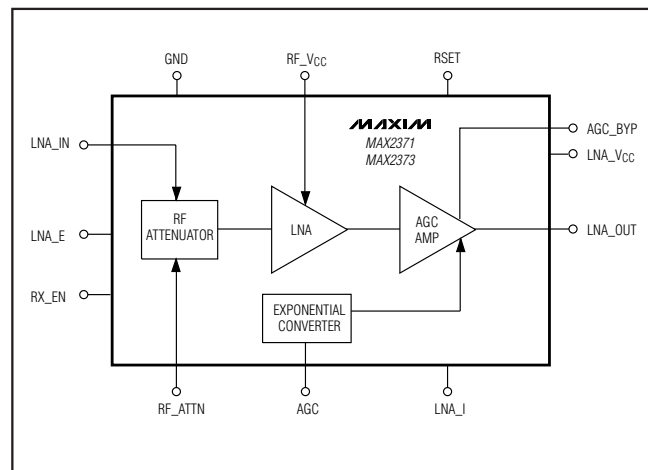

# LNAs with Step Attenuator and VGA

## ABSOLUTE MAXIMUM RATINGS

V<sub>CC</sub> to GND .....-0.3V to +3.6V  
 All Pins Excluding Grounds to Pin GND.....-0.3V to (V<sub>CC</sub> + 0.3V)  
 LNA Input Power (RX\_EN = low) .....5dBm  
 Continuous Power Dissipation (T<sub>A</sub> = +70°C)  
 12-Pin QFN (derate 11.9mW/°C above +70°C) .....952mW

Operating Temperature Range .....-40°C to +85°C  
 Junction Temperature .....+150°C  
 Storage Temperature Range .....-65°C to +160°C  
 Soldering Temperature (10s) .....+300°C

Stresses beyond those listed under "Absolute Maximum Ratings" may cause permanent damage to the device. These are stress ratings only, and functional operation of the device at these or any other conditions beyond those indicated in the operational sections of the specifications is not implied. Exposure to absolute maximum rating conditions for extended periods may affect device reliability.

## DC ELECTRICAL CHARACTERISTICS

(V<sub>CC</sub> = 2.775V, RX\_EN = high, R<sub>SET</sub> = 1.1kΩ, V<sub>AGC</sub> = V<sub>CC</sub>/2, T<sub>A</sub> = -40°C to +85°C. Typical values are at T<sub>A</sub> = +25°C, unless otherwise noted.)

| PARAMETER                | SYMBOL          | CONDITIONS                          | MIN                   | TYP                   | MAX             | UNITS |
|--------------------------|-----------------|-------------------------------------|-----------------------|-----------------------|-----------------|-------|
| Supply Voltage           | V <sub>CC</sub> |                                     | 2.65                  | 2.775                 | 3.30            | V     |
| Supply Current           | I <sub>CC</sub> | RX_EN = low, V <sub>CC</sub> = 3.3V |                       | 0.5                   | 20              | μA    |
|                          |                 | LNA_I = high, RF_ATTEN = low        |                       | 3.5                   | 5.5             | mA    |
|                          |                 | LNA_I = low                         |                       | 2.5                   | 3.5             | mA    |
| Digital Input Logic High | V <sub>IH</sub> | Pins LNA_I, RF_ATTEN, RX_EN         | 0.7 × V <sub>CC</sub> |                       | V <sub>CC</sub> | V     |
| Digital Input Logic Low  | V <sub>IL</sub> | Pins LNA_I, RF_ATTEN, RX_EN         | 0                     | 0.3 × V <sub>CC</sub> |                 | V     |
| Logic Pin Impedance      |                 | Logic pins RX_EN, RF_ATTEN, LNA_I   | 50                    |                       |                 | kΩ    |
| AGC Pin Impedance        |                 | Pins AGC                            | 100                   |                       |                 | kΩ    |

## AC ELECTRICAL CHARACTERISTICS

(MAX2371/MAX2373 EV Kits, V<sub>CC</sub> = 2.65V to 3.3V, RX\_EN = high, R<sub>SET</sub> = 1.1kΩ, T<sub>A</sub> = -40°C to +85°C. Typical values are at V<sub>CC</sub> = 2.775V; for MAX2371 f<sub>RF</sub> = 150MHz, for MAX2373 f<sub>RF</sub> = 850MHz to 940MHz; T<sub>A</sub> = +25°C, unless otherwise noted.) (Note 1)

| PARAMETER                              | CONDITIONS  |         | MIN  | TYP  | MAX  | UNITS |
|--|---|---------|------|------|------|-------|
| <b>LNA AND AGC AMP CHARACTERISTICS</b> |   |         |      |      |      |       |
| Radio Frequency Range (Note 2)         | Low band (MAX2371)  |         | 136  | 150  | 174  | MHz   |
|  | High band (MAX2373)   |         | 850  | 900  | 940  |       |
| Input Return Loss (S11)<br>(Note 3)    | LNA_I = high;<br>RF_ATTEN = low                                   | MAX2371 |      | -12  | -9.5 | dB    |
|  |   | MAX2373 |      | -15  | -9.5 |       |
|  | LNA_I = high;<br>RF_ATTEN = high                                  | MAX2371 |      | -14  | -10  |       |
|  |   | MAX2373 |      | -10  | -6.5 |       |
| Reverse Isolation (S12)                | Over AGC range  | MAX2371 |      | -40  | -35  | dB    |
|  |   | MAX2373 |      | -42  | -35  |       |
| Max Power Gain (Note 3)                | LNA_I = high, T <sub>A</sub> =<br>+25°C, V <sub>CC</sub> = 2.775V | MAX2371 | 13   | 14.5 | 16   | dB    |
|  |   | MAX2373 | 14   | 15.5 | 17   |       |
|  | LNA_I = low, T <sub>A</sub> =<br>+25°C, V <sub>CC</sub> = 2.775V  | MAX2371 | 10.5 | 12   |      |       |
|  |   | MAX2373 | 10.5 | 13   |      |       |
| Gain Variation Over Temperature        | T <sub>A</sub> = -40°C to +85°C, V <sub>AGC</sub> < 1.8V          |         | -2.0 |      | 2.0  | dB    |

# LNAs with Step Attenuator and VGA

MAX2371/MAX2373

## AC ELECTRICAL CHARACTERISTICS (continued)

(MAX2371/MAX2373 EV Kits,  $V_{CC} = 2.65V$  to  $3.3V$ ,  $RX\_EN = high$ ,  $R_{SET} = 1.1k\Omega$ ,  $T_A = -40^{\circ}C$  to  $+85^{\circ}C$ . Typical values are at  $V_{CC} = 2.775V$ ; for MAX2371  $f_{RF} = 150MHz$ , for MAX2373  $f_{RF} = 850MHz$  to  $940MHz$ ;  $T_A = +25^{\circ}C$ , unless otherwise noted.) (Note 1)

| PARAMETER                      | CONDITIONS  |                    | MIN     | TYP   | MAX  | UNITS |
|--------------------------------|---|--------------------|---------|-------|------|-------|
| SSB Noise Figure vs. AGC       | LNA_I = high, $T_A = +25^{\circ}C$ , $V_{CC} = 2.775V$ , $RF\_ATTN = low$                     | $V_{AGC} = 1.275V$ |         | 1.8   | 2.2  | dB    |
|                                |   | $V_{AGC} = 1.575V$ |         | 5.0   | 7.7  |       |
|                                |   | $V_{AGC} = 1.875V$ |         | 11    | 14.5 |       |
|                                |   | $V_{AGC} = 2.175V$ |         | 20    |      |       |
|                                | LNA_I = low, $T_A = +25^{\circ}C$ , $V_{CC} = 2.775V$ , $RF\_ATTN = low$                      | $V_{AGC} = 1.275V$ |         | 2.1   | 2.6  |       |
| Input 1dB Compression Point    | $RF\_ATTN = low$ , $V_{AGC} < 1.8V$   | LNA_I = high       | -21.5   | 19.5  | dBm  |       |
|                                |   | LNA_I = low        | -24     | -22   |      |       |
|                                | $RF\_ATTN = high$ , $V_{AGC} < 1.8V$  | LNA_I = high       | -3      | 0     |      |       |
|                                |   | LNA_I = low        | -9      | -6.5  |      |       |
| Input IP3 (Notes 4, 5)         | $RF\_ATTN = low$ , $V_{AGC} = V_{CC}/2$   | LNA_I = high       | -5      | -1    | dBm  |       |
|                                |   | LNA_I = low        | MAX2371 | -7    |      | -4    |
|                                | MAX2373   |                    | -12     | -9    |      |       |
|                                | $RF\_ATTN = high$ , $V_{AGC} = V_{CC}/2$ to $2.575V$  | LNA_I = high       | 9       | 13    | dBm  |       |
| Input IP3 Over AGC Range       | $RF\_ATTN = low$ , LNA_I = high, $V_{AGC} = V_{CC}/2$ to $1.80V$                              | MAX2371            | -10.5   | -8    | dBm  |       |
|                                |   | MAX2373            | -12.5   | -10.5 |      |       |
| <b>AGC RESPONSE</b>            |   |                    |         |       |      |       |
| AGC Attenuation Range (Note 6) | $V_{CC} = 2.775V$ , $RF\_ATTN = low$ , $V_{AGC} = 1.3375V$ to $2.575V$ , $T_A = +25^{\circ}C$ |                    | 35      | 45    |      | dB    |
| AGC Slope Over Control Range   | $RF\_ATTN = low$ , $V_{AGC} = 1.625V$   |                    | 32      | 40    | 47   | dB/V  |
|                                | $RF\_ATTN = high$ , $V_{AGC} = 1.625V$  |                    | 24      | 33    | 41   |       |
| <b>RF STEP ATTENUATOR</b>      |   |                    |         |       |      |       |
| Gain Step                      | $RF\_ATTN = high$ to $low$ , LNA_I = high   | MAX2371            | 16.0    | 17.5  | 19.0 | dB    |
|                                |   | MAX2373            | 18.0    | 19.5  | 21.0 |       |

**Note 1:** Parameters over temperature and supply voltage range are guaranteed by design and characterization, unless otherwise noted.

**Note 2:** Operation outside these frequency bands is possible but has not been characterized. See *Typical Operating Characteristics*.

**Note 3:** Measured with external matching network.

**Note 4:**  $f_{IN1} = 150MHz$ ,  $f_{IN2} = 150.1MHz$ ,  $P_{IN} = -30dBm$  for both tones (MAX2371).

**Note 5:**  $f_{IN1} = 900MHz$ ,  $f_{IN2} = 900.1MHz$ ,  $P_{IN} = -30dBm$  for both tones (MAX2373).

**Note 6:** Parameters are guaranteed by production test.

# LNAs with Step Attenuator and VGA

## Typical Operating Characteristics

(MAX2371/MAX2373 EV Kits,  $V_{CC} = 2.775V$ ,  $RX\_EN = \text{high}$ ,  $R_{SET} = 1.1k\Omega$ ,  $LNA\_I = \text{high}$ ,  $T_A = +25^\circ C$ . For MAX2371,  $f_{RF} = 150MHz$ ; for MAX2373,  $f_{RF} = 900MHz$ , unless otherwise noted.)

### MAX2371

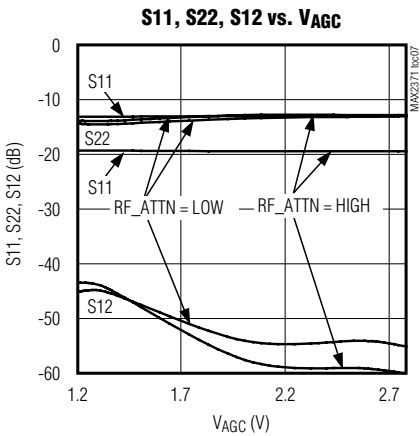
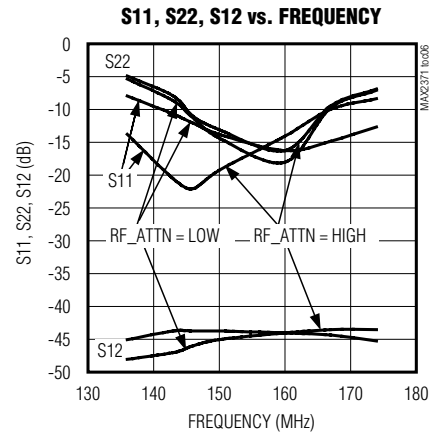
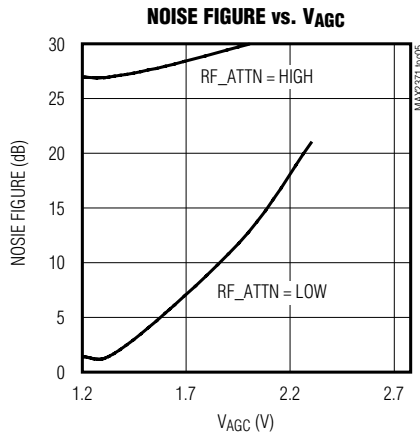
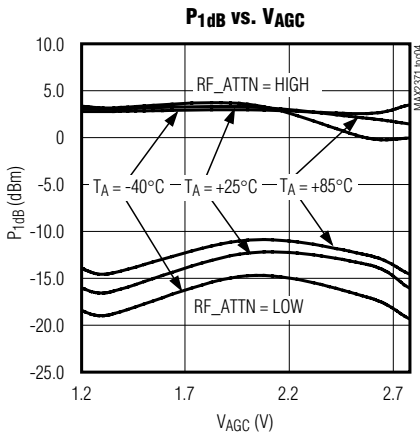
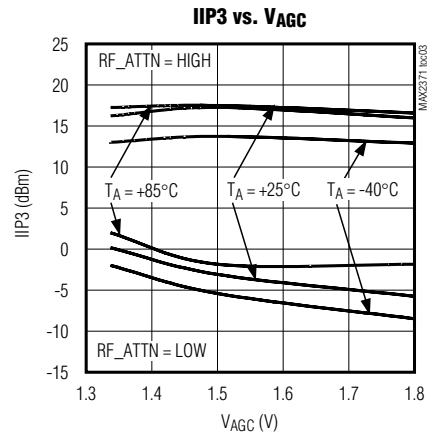
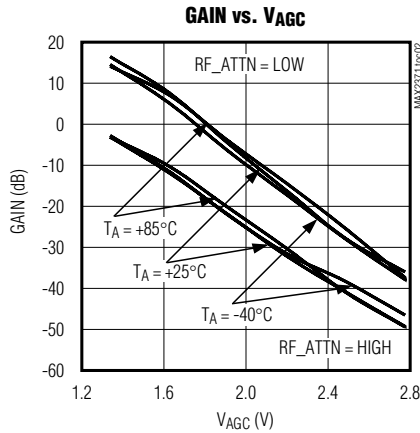
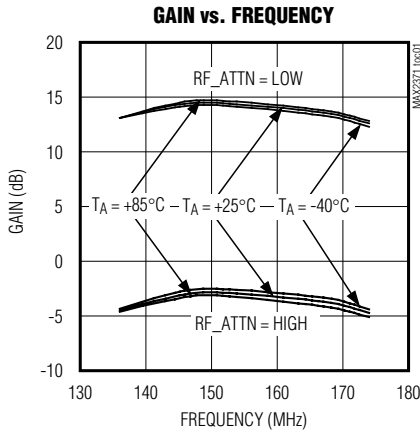

# LNAs with Step Attenuator and VGA

## Typical Operating Characteristics (continued)

(MAX2371/MAX2373 EV Kits,  $V_{CC} = 2.775V$ ,  $RX\_EN = \text{high}$ ,  $R_{SET} = 1.1k\Omega$ ,  $LNA\_I = \text{high}$ ,  $T_A = +25^\circ C$ . For MAX2371,  $f_{RF} = 150MHz$ ; for MAX2373,  $f_{RF} = 900MHz$ , unless otherwise noted.)

### MAX2373

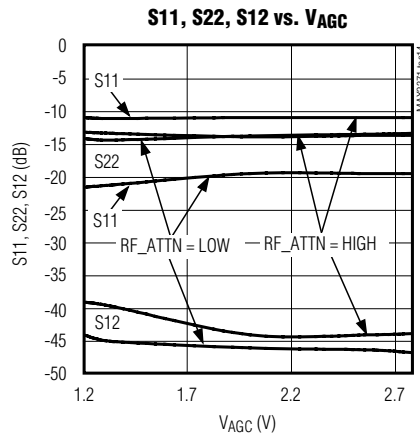
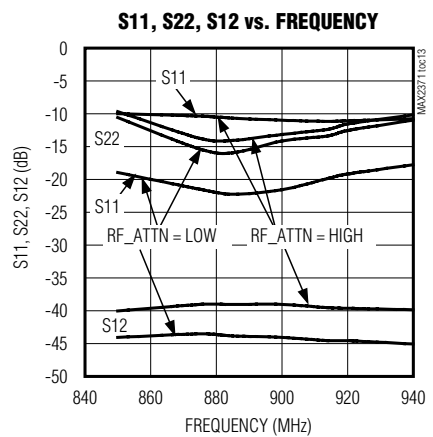
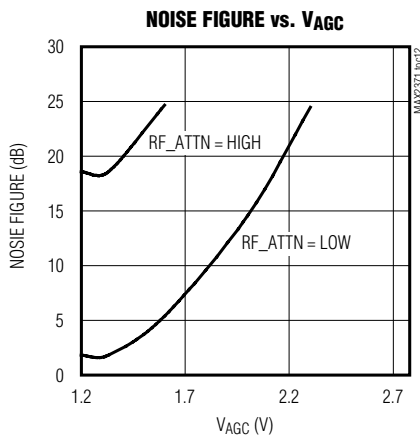
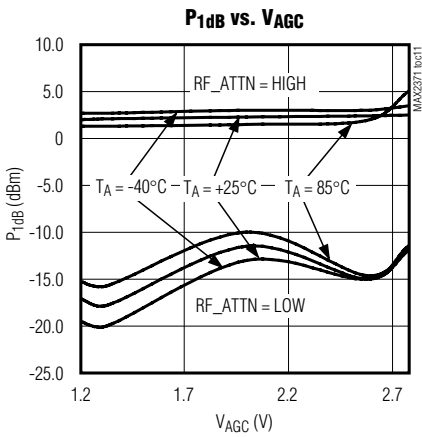
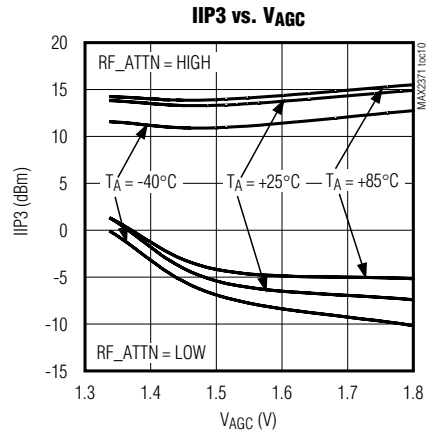
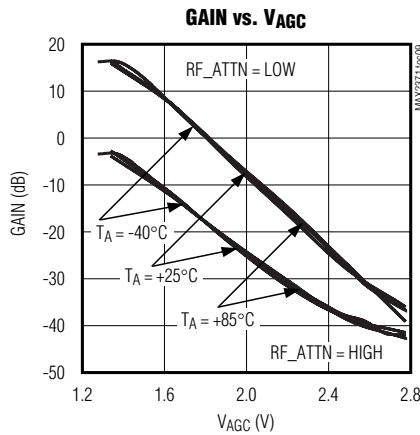
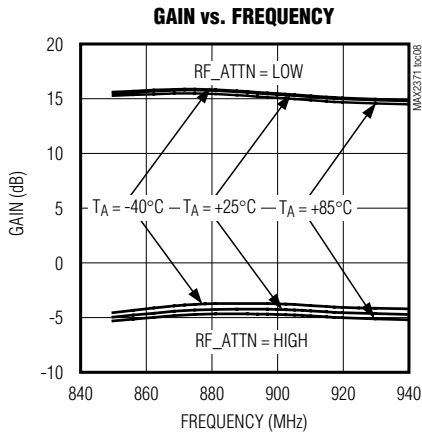

MAX2371/MAX2373

# LNAs with Step Attenuator and VGA

MAX2371/MAX2373

**Table 1. MAX2371 S-Parameters**

(V<sub>CC</sub> = 2.775V, RX\_EN = high, LNA\_I = high, RF\_ATTN = low, P<sub>IN</sub> = -30dBm, T<sub>A</sub> = +25°C.)

| FREQUENCY<br>(MHz) | LNA (S11) |           | LNA (S21) |          | LNA (S12) |          | LNA (S22) |          |
|--------------------|-----------|-----------|-----------|----------|-----------|----------|-----------|----------|
|                    | MAGNITUDE | PHASE     | MAGNITUDE | PHASE    | MAGNITUDE | PHASE    | MAGNITUDE | PHASE    |
| 10                 | 0.943409  | -4.8477   | 5.980672  | 171.1200 | 0.002136  | -102.490 | 0.998803  | -1.1632  |
| 100                | 0.746965  | -29.9420  | 2.959750  | 102.1900 | 0.002021  | 61.149   | 0.994752  | -4.4481  |
| 150                | 0.728794  | -35.6990  | 2.347308  | 89.6950  | 0.003089  | 138.790  | 0.985485  | -6.0754  |
| 200                | 0.705066  | -43.4190  | 1.769355  | 75.0130  | 0.003238  | 47.793   | 0.986870  | -7.7399  |
| 300                | 0.704636  | -55.1180  | 1.290313  | 58.1420  | 0.004439  | 83.493   | 0.979073  | -11.1180 |
| 400                | 0.719615  | -65.2420  | 1.060230  | 45.42700 | 0.003346  | 82.612   | 0.963130  | -14.6680 |
| 500                | 0.731998  | -73.5040  | 0.930754  | 36.0670  | 0.004395  | 68.614   | 0.947862  | -18.0970 |
| 600                | 0.736258  | -80.6450  | 0.849660  | 28.4990  | 0.006155  | 71.599   | 0.935998  | -21.2670 |
| 700                | 0.738074  | -85.6220  | 0.810047  | 22.7470  | 0.004143  | 56.224   | 0.930518  | -23.5710 |
| 800                | 0.738465  | -89.2240  | 0.796627  | 18.1080  | 0.005580  | 93.741   | 0.935158  | -25.5640 |
| 900                | 0.736843  | -91.6690  | 0.793643  | 14.3230  | 0.005309  | 89.871   | 0.933372  | -27.8980 |
| 1000               | 0.720668  | -94.0260  | 0.801946  | 9.9632   | 0.007592  | 99.418   | 0.941369  | -30.2110 |
| 1100               | 0.712090  | -96.1830  | 0.816554  | 5.9889   | 0.008451  | 122.090  | 0.940860  | -32.2310 |
| 1200               | 0.690343  | -98.0560  | 0.836893  | 1.1604   | 0.011955  | 129.220  | 0.936774  | -34.6290 |
| 1300               | 0.657098  | -100.3900 | 0.861113  | -4.3698  | 0.014966  | 130.200  | 0.930219  | -37.6190 |
| 1400               | 0.606583  | -103.2500 | 0.891302  | -10.2610 | 0.019602  | 131.440  | 0.925103  | -40.1400 |
| 1500               | 0.545500  | -106.6300 | 0.925092  | -16.1910 | 0.023963  | 128.730  | 0.926670  | -42.0800 |
| 1600               | 0.469143  | -111.0400 | 0.966707  | -23.1040 | 0.031521  | 121.710  | 0.939042  | -43.7830 |
| 1700               | 0.372315  | -116.0200 | 1.002767  | -29.9130 | 0.039505  | 114.740  | 0.949456  | -45.2980 |
| 1800               | 0.267147  | -123.3900 | 1.021504  | -37.6360 | 0.047321  | 109.530  | 0.966296  | -46.5300 |
| 1900               | 0.150522  | -137.6100 | 1.021081  | -45.7240 | 0.056859  | 100.480  | 0.975001  | -48.7600 |
| 2000               | 0.060478  | 160.4700  | 0.995004  | -53.5490 | 0.063929  | 92.788   | 0.971740  | -50.8360 |

# LNAs with Step Attenuator and VGA

MAX2371/MAX2373

**Table 2. MAX2373 S-Parameters**

(V<sub>CC</sub> = 2.775V, RX\_EN = high, LNA\_I = high, RF\_ATTN = low, P<sub>IN</sub> = -30dBm, T<sub>A</sub> = +25°C.)

| FREQUENCY<br>(MHz) | LNA (S11) |          | LNA (S21) |          | LNA (S12) |          | LNA (S22) |          |
|--------------------|-----------|----------|-----------|----------|-----------|----------|-----------|----------|
|                    | MAGNITUDE | PHASE    | MAGNITUDE | PHASE    | MAGNITUDE | PHASE    | MAGNITUDE | PHASE    |
| 10                 | 0.952248  | -0.8171  | 7.273610  | -178.830 | 0.002162  | -89.276  | 1.000092  | -0.8184  |
| 100                | 0.933405  | -9.1461  | 7.077013  | 163.940  | 0.001346  | 78.684   | 0.993482  | -2.3140  |
| 200                | 0.884179  | -16.6570 | 6.529802  | 150.770  | 0.002137  | 32.634   | 0.991791  | -3.8136  |
| 300                | 0.824784  | -22.6500 | 5.929253  | 139.770  | 0.002217  | 72.860   | 0.983762  | -5.6360  |
| 400                | 0.767609  | -27.4800 | 5.400078  | 130.020  | 0.001332  | 86.532   | 0.971102  | -7.2455  |
| 500                | 0.709643  | -30.9910 | 4.904559  | 121.750  | 0.001641  | 86.431   | 0.958562  | -8.9841  |
| 600                | 0.656682  | -34.5840 | 4.431492  | 113.750  | 0.002297  | 70.617   | 0.955972  | -10.7250 |
| 700                | 0.616673  | -37.2530 | 4.016983  | 107.480  | 0.001701  | 105.050  | 0.946259  | -12.1890 |
| 800                | 0.586388  | -39.7830 | 3.644182  | 101.820  | 0.002688  | 73.619   | 0.941846  | -13.4650 |
| 900                | 0.558837  | -41.8580 | 3.313218  | 97.239   | 0.001077  | 143.410  | 0.933168  | -15.1090 |
| 1000               | 0.536056  | -42.9140 | 3.059039  | 92.435   | 0.001617  | 102.100  | 0.938912  | -16.8900 |
| 1100               | 0.524439  | -44.4030 | 2.805078  | 87.484   | 0.001442  | 151.320  | 0.932492  | -18.5160 |
| 1200               | 0.516220  | -45.9560 | 2.614027  | 82.687   | 0.002973  | 178.790  | 0.926200  | -20.8080 |
| 1300               | 0.511487  | -47.1900 | 2.417436  | 78.482   | 0.003764  | -175.540 | 0.919094  | -23.6930 |
| 1400               | 0.508259  | -47.9420 | 2.253642  | 74.093   | 0.004195  | -176.470 | 0.919952  | -25.7200 |
| 1500               | 0.504028  | -49.1020 | 2.090210  | 70.061   | 0.007366  | -163.150 | 0.917498  | -27.9410 |
| 1600               | 0.509736  | -50.1550 | 1.975627  | 66.443   | 0.008200  | -162.620 | 0.919486  | -29.8050 |
| 1700               | 0.510000  | -51.3530 | 1.841259  | 63.336   | 0.010929  | -163.870 | 0.923092  | -32.1340 |
| 1800               | 0.513009  | -52.9500 | 1.719293  | 59.870   | 0.015327  | -160.350 | 0.924634  | -33.9510 |
| 1900               | 0.515994  | -54.6510 | 1.597405  | 56.385   | 0.016692  | -162.560 | 0.933781  | -36.3470 |
| 2000               | 0.510141  | -55.6650 | 1.467185  | 53.411   | 0.018843  | -177.660 | 0.933039  | -38.8240 |

**Table 3. MAX2371 Typical Noise Parameters**

(V<sub>CC</sub> = 2.775V, RX\_EN = high, LNA\_I = high, RF\_ATTN = low, P<sub>IN</sub> = -30dBm, T<sub>A</sub> = +25°C, data from design simulation.)

| FREQUENCY (MHz) | NF <sub>MIN</sub> (dB) | Γ <sub>OPT</sub> | ∠Γ <sub>OPT</sub> | R <sub>N</sub> (Ω) |
|-----------------|------------------------|------------------|-------------------|--------------------|
| 130             | 0.84                   | 0.34             | 46.4              | 8.8                |
| 140             | 0.83                   | 0.35             | 49.3              | 8.5                |
| 150             | 0.82                   | 0.34             | 52.7              | 8.1                |
| 160             | 0.81                   | 0.34             | 56.2              | 7.8                |
| 170             | 0.81                   | 0.33             | 59.8              | 7.5                |
| 180             | 0.81                   | 0.32             | 63.4              | 7.1                |

# LNAs with Step Attenuator and VGA

**Table 4. MAX2373 Typical Noise Parameters**

 (V<sub>CC</sub> = 2.775V, RX\_EN = high, LNA\_I = high, RF\_ATTEN = low, P<sub>IN</sub> = -30dBm, T<sub>A</sub> = +25°C, data from design simulation.)

| FREQUENCY (MHz) | NF <sub>MIN</sub> (dB) | Γ <sub>OPT</sub> | ∠Γ <sub>OPT</sub> | R <sub>N</sub> (Ω) |
|-----------------|------------------------|------------------|-------------------|--------------------|
| 850             | 1.06                   | 0.35             | 60.5              | 10.02              |
| 870             | 1.08                   | 0.35             | 61.8              | 9.98               |
| 890             | 1.10                   | 0.34             | 63.3              | 9.94               |
| 910             | 1.11                   | 0.34             | 64.7              | 9.90               |
| 930             | 1.13                   | 0.33             | 66.2              | 9.86               |
| 950             | 1.15                   | 0.33             | 67.7              | 9.82               |

## Pin Description

| PIN | NAME                | FUNCTION  |
|-----|---------------------|---|
| 1   | LNA_IN              | RF Input. Requires DC-blocking capacitor and external matching network.   |
| 2   | LNA_E               | LNA Emitter. Connect to GND with an inductor. See inductor value in Table 5.  |
| 3   | RX_EN               | LNA Control. Set RX_EN high to enable LNA; set RX_EN low to disable LNA.  |
| 4   | RF_ATTEN            | Attenuator Control. Set RF_ATTEN high for low-gain mode; set RF_ATTEN low for high-gain mode.   |
| 5   | AGC                 | AGC Input Voltage. Set AGC to V <sub>CC</sub> /2 for maximum gain. Set AGC to V <sub>CC</sub> - 200mV for minimum gain. If left unconnected, the LNA will operate at maximum gain and optimum noise figure. |
| 6   | LNA_I               | LNA Nominal Bias-Current Setting. Set LNA_I high for high-current mode. Set LNA_I low for low-current mode. If left unconnected, the default state of the LNA is high-current mode.                         |
| 7   | LNA_OUT             | RF Output Pin. Requires a pullup inductor to LNA_V <sub>CC</sub> and external matching network.   |
| 8   | LNA_V <sub>CC</sub> | Supply Voltage for the AGC Amplifier  |
| 9   | AGC_BYP             | AGC Bypass. Connect a capacitor to ground. The value of the capacitor is a compromise of AGC response time and blocker frequency offset.  |
| 10  | RSET                | External pin for precision resistor to ground to set reference bias current for IC; typical bias current is 50μA to 100μA.  |
| 11  | RF_V <sub>CC</sub>  | Supply Voltage for the LNA. Bypass with a capacitor to GND as close to the pin as possible. Do NOT connect any tuned circuits to this supply pin.   |
| 12  | GND                 | Ground  |
| EP  | Exposed Pad         | Internally connected to GND. Connect to a large ground plane to maximize thermal performance. Do not use as the sole ground connection point.   |

**Table 5. Inductor Selection**

| BAND         | L SERIES VALUE (nH) | LNA TYPE  |
|--------------|---------------------|-----------|
| 150MHz (VHF) | 33                  | Low Band  |
| 450MHz (UHF) | 10                  | Low Band  |
| 450MHz (UHF) | 2.7                 | High Band |
| 800MHz       | 2.5                 | High Band |
| 1GHz         | 1.8                 | High Band |

## Detailed Description

The MAX2371/MAX2373 are single-channel, single-ended, low-noise amplifiers with two gain modes and continuous automatic gain control (AGC) in both modes. The devices are intended as low-noise gain

stages for direct conversion receivers (DCR) or very low IF (VLIF) receivers. These devices provide high gain-control dynamic range (typ 60dB) at RF with excellent noise and reverse isolation characteristics.

Vary the resistor at pin RSET and the inductor at LNA\_E to meet a wide range of gain and linearity requirements. The ICs can be dynamically configured through pins LNA\_I and RF\_ATTEN. When LNA\_I is connected to V<sub>CC</sub>, the LNA is in high-current mode, nominally configured for maximum gain and low noise figure of the amplifier. If the LNA\_I pin is grounded, the current of the LNA is reduced, and the associated gain, input IP3, and noise figure are degraded. The devices have two gain modes configured by the RF\_ATTEN pin. Set RF\_ATTEN high for low-gain mode; set RF\_ATTEN low for high-gain mode. The gain step between these two gain modes typically is 20dB.



# LNAs with Step Attenuator and VGA

The MAX2371/MAX2373 can be turned off in transmit or battery-save standby mode. The receive-enable pin (RX\_EN) also can turn off the devices even if V<sub>CC</sub> is not removed, because multiple LNAs can be connected to the same V<sub>CC</sub> for multiband applications.

The devices allow external matching networks to configure operation in a wide frequency range. Refer to the EV kit schematic for a guide to designing the matching network.

## Applications Information

### AGC

The AGC of the MAX2371/MAX2373 is controlled by an external voltage at pin AGC. The amplifier is at full gain if the voltage at pin AGC is nominally V<sub>CC</sub>/2. It is at minimum gain if the voltage at pin AGC is V<sub>CC</sub>. The AGC attenuation range, which is continuously variable, is specified at 45dB. The IP<sub>3</sub> will degrade slightly as AGC reduces the gain.

The devices include two gain modes. Set RF\_ATTEN high to enable the low-gain mode, which reduces the gain by about 20dB. Low-gain mode will increase the system IP<sub>3</sub> by approximately 18dB, which provides strong signal overload and IM protection. An external pin (RF\_ATTEN) controls switching between gain modes so this function can be combined with overall AGC control. AGC is independent of the choice of gain mode. The gain step between modes is in addition to the range of AGC, allowing a large overall gain-control range.

### AGC Response

A linear transfer function between the AGC control signal and the AGC attenuation is realized in dB. The linear relationship in dB/V is maintained to ±10% over a specified attenuation range. Any compensation for gain-mode change must come from the AGC control. After reducing gain by switching the RF\_ATTEN pin, reduce the AGC voltage to achieve the desired overall gain.

The LNA current also can be changed by toggling the LNA\_I pin. This operation is independent of gain mode and AGC control. The low-current mode is intended as a second (reduced-current) quiescent point of operation for strong-signal operating environments.

### Matching Networks

For best performance, match LNA\_IN and LNA\_OUT to 50Ω for the band of operation. Typical matching circuits for two bands (136MHz to 174MHz and 850MHz to 940MHz) are shown in the EV kit. The chip impedance changes minimally from low to high gain and with AGC. The input requires a DC-blocking capacitor. The size of this capacitor influences the startup time and IP<sub>3</sub>. There is a trade-off between these: A large DC-blocking

capacitor means a good IP<sub>3</sub> and slow startup. The maximum startup time is determined by the equation below:

$$\text{MAXTSTART} = 40 \times C_{AC} \times R_{SET}$$

where C<sub>AC</sub> = AC-coupling cap in Farads, R<sub>SET</sub> = current-setting resistor in Ω.

IP<sub>3</sub> will improve with the separation of the interfering tones, so a wider channel system can use a smaller DC-blocking capacitor and achieve a better IP<sub>3</sub>. The customer also can change the emitter inductor at LNA\_E to get the desired linearity and gain. Changing this inductor value requires a change to the input match. The output is an open collector and needs a pullup inductor. A load resistor also can be connected across it. The resistor determines the trade-off between the bandwidth of the match and the gain. A small load resistor means a wider match and lower gain.

## Layout Issues

For best performance, pay attention to power-supply issues as well as to the layout of the RFOUT matching network. The EV kit can be used as a layout example. Ground connections followed by supply bypass are the most important.

### Power-Supply Bypassing

The MAX2371/MAX2373 have two supply pins: LNA\_V<sub>CC</sub> and RF\_V<sub>CC</sub>. These must be bypassed separately. It is assumed that there is a large capacitor decoupling the power supply. LNA\_V<sub>CC</sub> and RF\_V<sub>CC</sub> are each decoupled with 1500pF (MAX2371) or 100pF (MAX2373) capacitor. Use separate paths to the ground plane for each of the bypass capacitors, and minimize trace length to reduce inductance. The exposed pad must be connected to system ground with very low impedance vias.

### Power-Supply Layout

To minimize coupling between sections of the IC, the ideal power-supply layout is a star configuration with a large decoupling capacitor at a central V<sub>CC</sub> node. The V<sub>CC</sub> traces branch from this central node, each to a separate V<sub>CC</sub> node in the PC board. At the end of each trace is a bypass capacitor that has low ESR at the RF of operation. This arrangement provides local decoupling at each V<sub>CC</sub> pin. At high frequencies, any signal leaking out of one supply pin sees a relatively high impedance (formed by the V<sub>CC</sub> trace inductance) to the central V<sub>CC</sub> node and an even higher impedance to any other supply pin, as well as a low impedance to ground through the bypass capacitor.

# LNAs with Step Attenuator and VGA

## Typical Operating Circuits

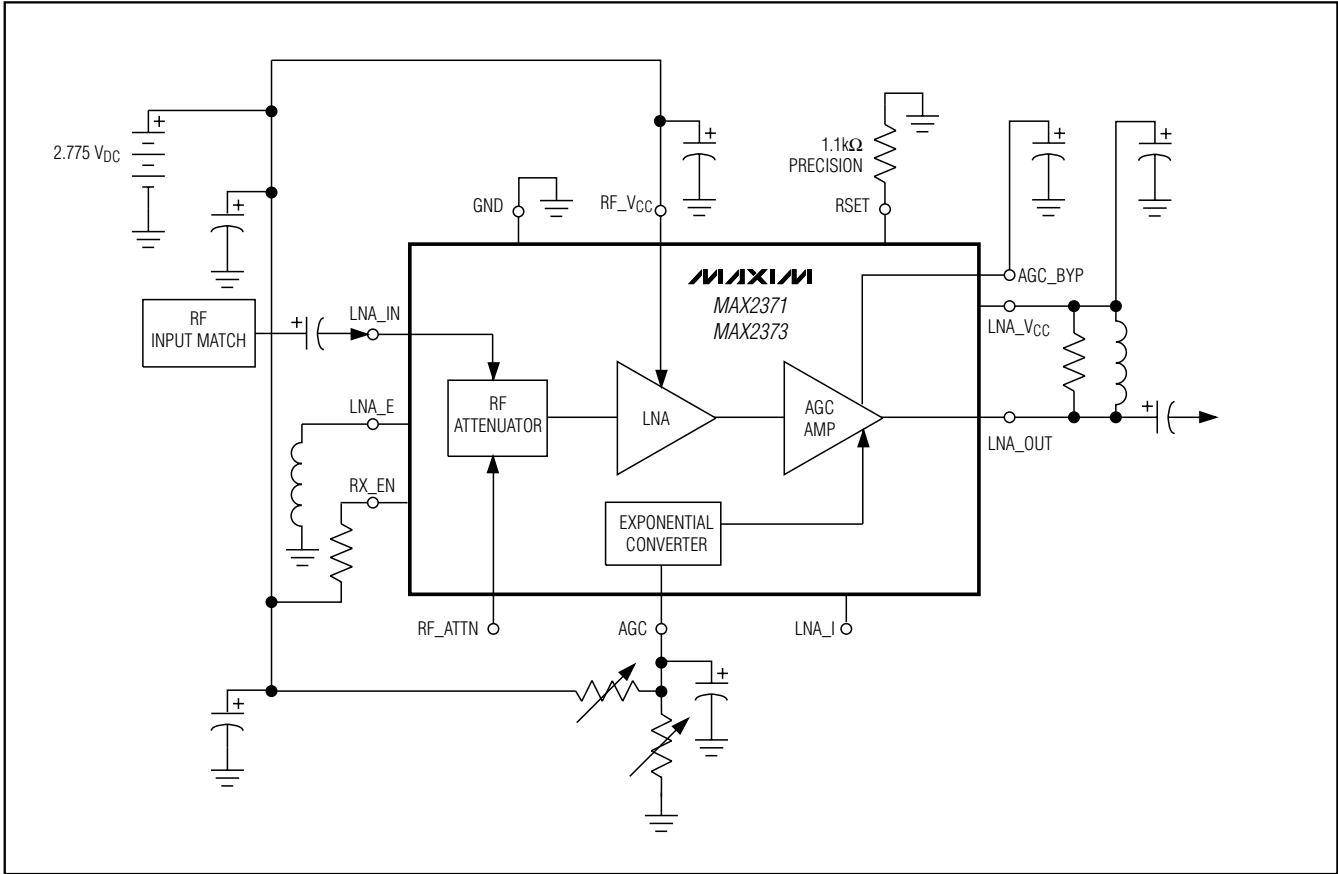

### Impedance-Matching Network Layout

The input- and output-matching networks are sensitive to layout-related parasitic inductions. To minimize parasitic inductance, keep traces short and place components as close as possible to the chip. To minimize parasitic capacitance, minimize the area of the plane.

### Chip Information

TRANSISTOR COUNT: 360

### Revision History

Pages changed at Rev 1: 1, 8, 10

Maxim cannot assume responsibility for use of any circuitry other than circuitry entirely embodied in a Maxim product. No circuit patent licenses are implied. Maxim reserves the right to change the circuitry and specifications without notice at any time.

**Maxim Integrated Products, 120 San Gabriel Drive, Sunnyvale, CA 94086 408-737-7600**