



10-Bit, Low-Power, Rail-to-Rail Voltage-Output Serial DAC in SOT23

MAX5711

General Description

The MAX5711 is a small footprint, low-power, 10-bit digital-to-analog converter (DAC) that operates from a single +2.7V to +5.5V supply. The MAX5711 on-chip precision output amplifier provides Rail-to-Rail® output swing. Drawing an 85µA supply current at 3V, the MAX5711 is ideally suited to portable battery-operated equipment.

The MAX5711 utilizes a 3-wire serial interface compatible with SPI™/QSPI™/MICROWIRE™ and DSP-interface standards. All logic inputs are CMOS-logic compatible and buffered with Schmitt triggers to allow direct interfacing to optocouplers. The MAX5711 incorporates a power-on reset (POR) circuit that ensures that the DAC begins in a zero-volt-state upon power-up. A power-down mode that reduces current consumption to 0.3µA may be initiated through a software command.

The MAX5711 is available in a small 6-pin SOT23 package. For dual and quad 10-bit versions, see the MAX5721 and MAX5741 data sheets. For single, dual, and quad 12-bit versions, see the MAX5712, MAX5722, and MAX5742 data sheets. The MAX5711 is specified over the automotive temperature range of -40°C to +125°C.

Applications

- Automatic Tuning
- Gain and Offset Adjustment
- Power Amplifier Control
- Process Control I/O Boards
- Battery-Powered Equipment
- VCO Control

*Rail-to-Rail is a registered trademark of Nippon Motorola, Ltd.
SPI and QSPI are trademarks of Motorola, Inc.
MICROWIRE is a trademark of National Semiconductor, Corp.*

Functional Diagram

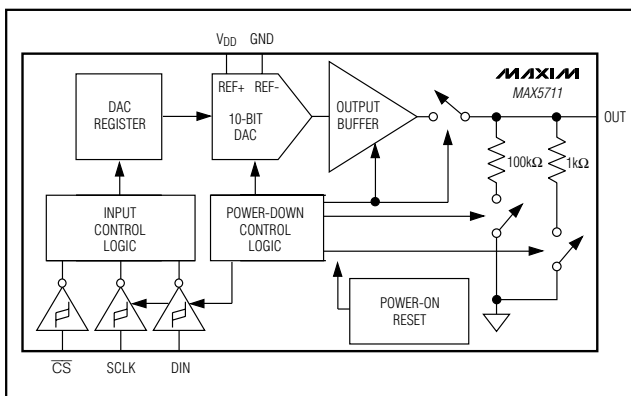

Features

- ◆ Wide -40°C to +125°C Operating Temperature Range
- ◆ Low 85µA Supply Current
- ◆ Ultra Low 0.3µA Power-Down Supply Current
- ◆ Single +2.7V to +5.5V Supply Voltage
- ◆ Fast 20MHz 3-Wire SPI/QSPI/MICROWIRE and DSP-Compatible Serial Interface
- ◆ Schmitt-Triggered Inputs for Direct Interfacing to Optocouplers
- ◆ Rail-to-Rail Output Buffer
- ◆ Power-On Reset to Zero Volts
- ◆ Three Software-Selectable Power-Down Output Impedances (100kΩ, 1kΩ, Hi-Z)
- ◆ Tiny 6-Pin SOT23 Package

Ordering Information

PART	TEMP. RANGE	PIN-PACKAGE	TOP MARK
MAX5711EUT	-40°C to +85°C	6 SOT23	ABCP
MAX5711AUT	-40°C to +125°C	6 SOT23	AAUC

Pin Configuration

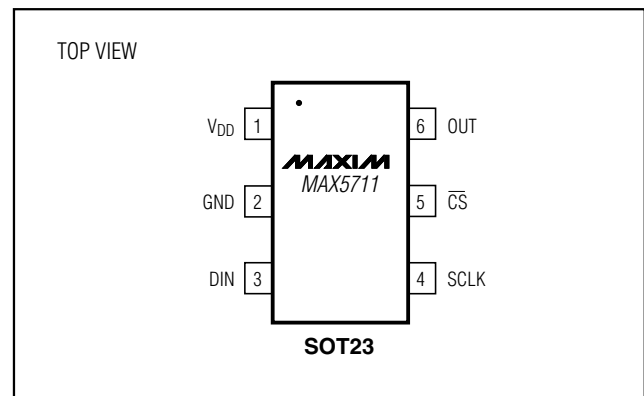

10-Bit, Low-Power, Rail-to-Rail Voltage-Output Serial DAC in SOT23

ABSOLUTE MAXIMUM RATINGS

V _{DD} to GND	-0.3V to +6V	Operating Temperature Range	
OUT, SCLK, DIN, $\overline{\text{CS}}$ to GND	-0.3V to (V _{DD} + 0.3V)	MAX5711EUT	-40°C to +85°C
Maximum Current into Any Pin	±50mA	MAX5711AUT	-40°C to +125°C
Continuous Power Dissipation (T _A = +70°C)		Maximum Junction Temperature	+150°C
6-Pin SOT23 (derate 9.1mW/°C above +70°C).....	727mW	Storage Temperature Range	-65°C to +150°C
		Lead Temperature (soldering, 10s)	+300°C

Stresses beyond those listed under "Absolute Maximum Ratings" may cause permanent damage to the device. These are stress ratings only, and functional operation of the device at these or any other conditions beyond those indicated in the operational sections of the specifications is not implied. Exposure to absolute maximum rating conditions for extended periods may affect device reliability.

ELECTRICAL CHARACTERISTICS

(V_{DD} = +2.7V to +5.5V, GND = 0, R_L = 5k Ω , C_L = 200pF, T_A = T_{MIN} to T_{MAX}, unless otherwise noted. Typical values are at V_{DD} = +5V, T_A = +25°C.)

PARAMETER	SYMBOL	CONDITIONS	MIN	TYP	MAX	UNITS
STATIC ACCURACY (NOTE 1)						
Resolution	N		10			Bits
Integral Nonlinearity Error	INL	(Note 2)		±0.5	±4	LSB
Differential Nonlinearity Error	DNL	Guaranteed monotonic (Note 2)			±1	LSB
Zero-Code Error	OE	Code = 000		0.4	1.5	% of FS
Zero-Code Error Tempco				2.3		ppm/°C
Gain Error	GE	Code = 3FF hex			-3	% of FS
Gain Error Tempco				0.26		ppm/°C
DAC OUTPUT						
Output Voltage Range		No load (Note 3)	0		V _{DD}	V
DC Output Impedance		Code = 200 hex		0.8		Ω
Short-Circuit Current		V _{DD} = +3V		15		mA
		V _{DD} = +5V		48		
Wake-Up Time		V _{DD} = +3V		8		μ s
		V _{DD} = +5V		8		
Output Leakage Current		Power-down mode = output high impedance		±18		nA
DIGITAL INPUTS (SCLK, DIN, $\overline{\text{CS}}$)						
Input High Voltage	V _{IH}	V _{DD} = +3V, +5V	0.7 x V _{DD}			V
Input Low Voltage	V _{IL}	V _{DD} = +3V, +5V			0.3 x V _{DD}	V
Input Leakage Current	I _{IN}	Digital inputs = 0 or V _{DD}		±0.1	±1	μ A
Input Capacitance	C _{IN}			5		pF

10-Bit, Low-Power, Rail-to-Rail Voltage-Output Serial DAC in SOT23

ELECTRICAL CHARACTERISTICS (continued)

($V_{DD} = +2.7V$ to $+5.5V$, $GND = 0$, $R_L = 5k\Omega$, $C_L = 200pF$, $T_A = T_{MIN}$ to T_{MAX} , $T_A = +25^\circ C$, unless otherwise noted. Typical values are at $V_{DD} = +5V$, $T_A = +25^\circ C$.)

PARAMETER	SYMBOL	CONDITIONS	MIN	TYP	MAX	UNITS
DYNAMIC PERFORMANCE						
Voltage Output Slew Rate	SR			0.5		V/ μ s
Voltage Output Settling Time		100 hex to 300 hex (Note 4)		4	10	μ s
Digital Feedthrough		Any digital inputs from 0 or V_{DD}		0.2		nV-s
Digital-Analog Glitch Impulse		Major carry transition (code 1FF hex to code 200 hex)		12		nV-s
POWER REQUIREMENTS						
Supply Voltage Range	V_{DD}		2.7		5.5	V
Supply Current with No Load	I_{DD}	All digital inputs at 0 or V_{DD} , $V_{DD} = 3.6V$		85	150	μ A
		All digital inputs at 0 or V_{DD} , $V_{DD} = 5.5V$		105	187	
Power-Down Supply Current	I_{DDPD}	All digital inputs at 0 or V_{DD} , $V_{DD} = 5.5V$		0.29	1	μ A
TIMING CHARACTERISTICS (FIGURE 2) (Timing is tested with no load)						
SCLK Clock Frequency	fSCLK		0		20	MHz
SCLK Pulse Width High	tCH		20			ns
SCLK Pulse Width Low	tCL		20			ns
\overline{CS} Fall to SCLK Rise Setup	tCSS		15			ns
DIN Setup Time	tDS		15			ns
DIN Hold Time	tDH		0			ns
SCLK Falling Edge to \overline{CS} Rising Edge	tCSH		10			ns
\overline{CS} Pulse Width High	tCSW		80			ns

Note 1: DC specifications are tested without output loads.

Note 2: Linearity guaranteed from code 29 to code 995.

Note 3: Offset and gain error limit the FSR.

Note 4: Guaranteed by design.

Typical Operating Characteristics

($T_A = +25^\circ C$, unless otherwise noted.)

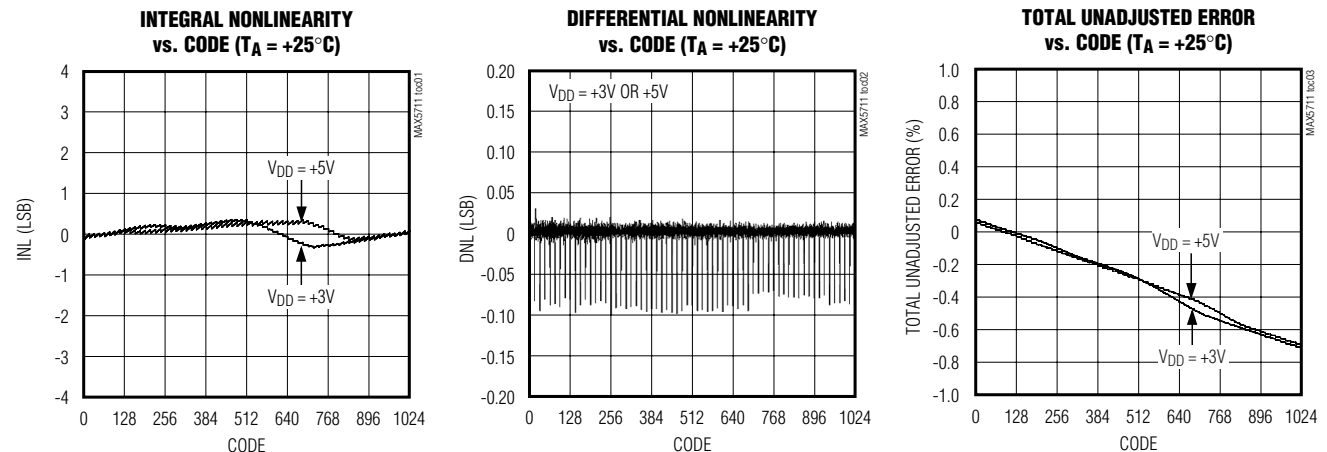

10-Bit, Low-Power, Rail-to-Rail Voltage-Output Serial DAC in SOT23

Typical Operating Characteristics (continued)

($T_A = +25^\circ\text{C}$, unless otherwise noted.)

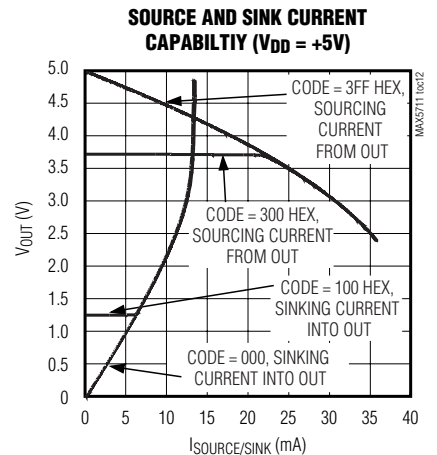
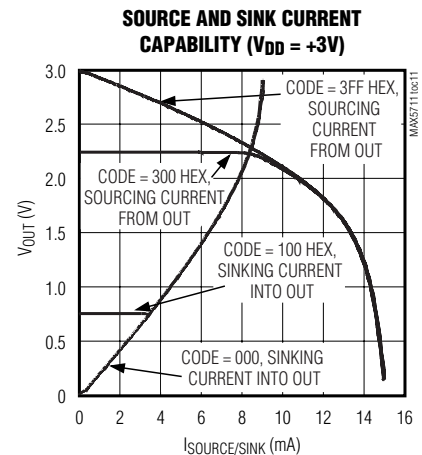
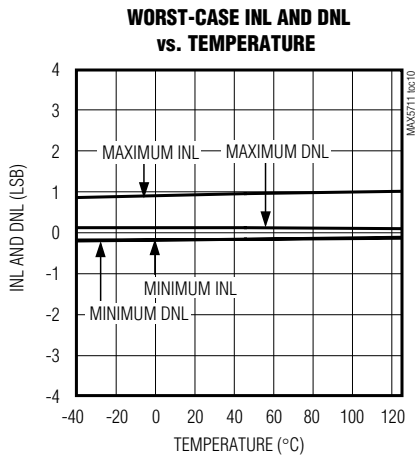
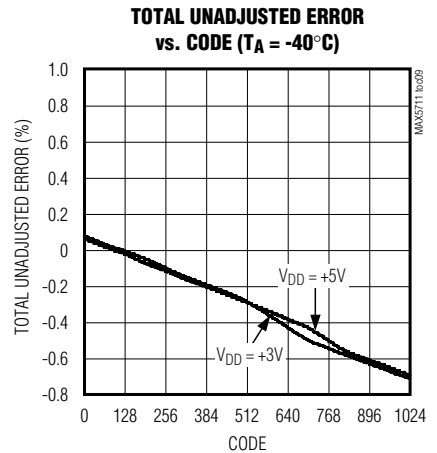
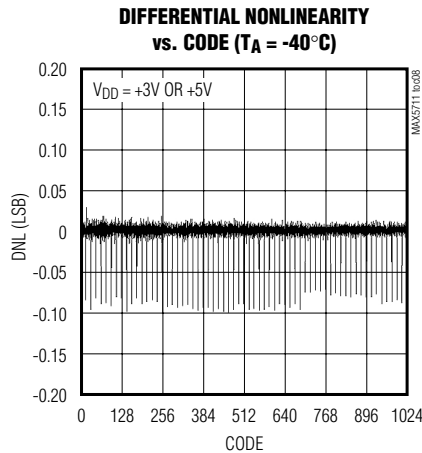
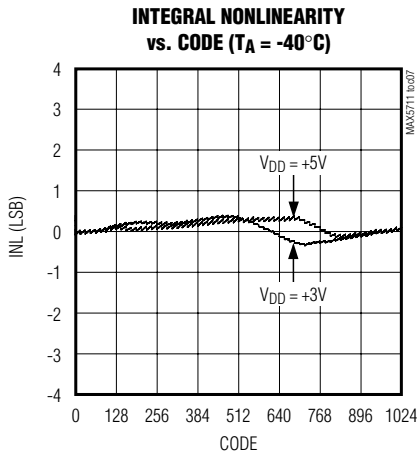
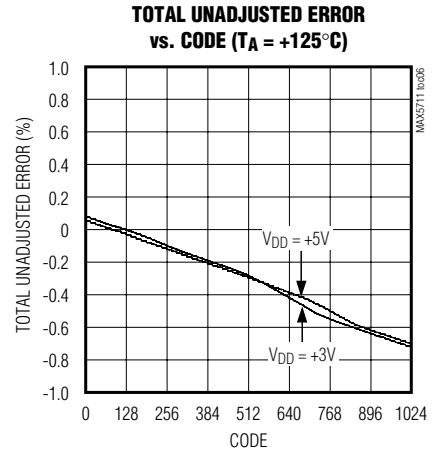
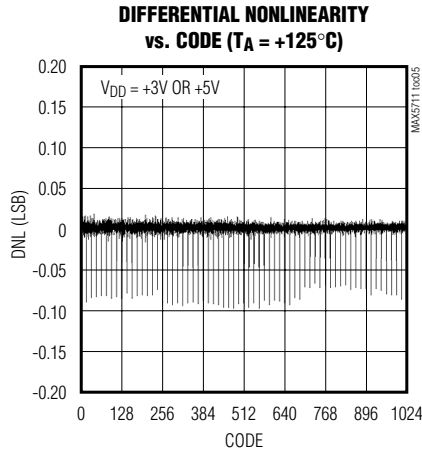
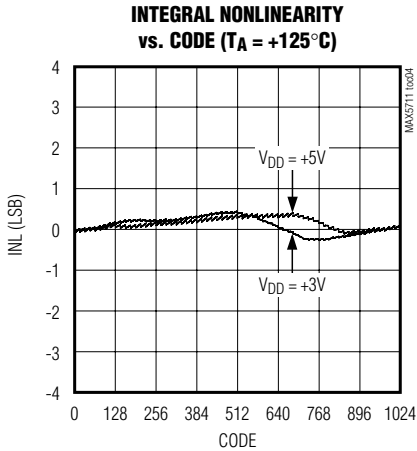

10-Bit, Low-Power, Rail-to-Rail Voltage-Output Serial DAC in SOT23

Typical Operating Characteristics (continued)

($T_A = +25^\circ\text{C}$, unless otherwise noted.)

MAX5711

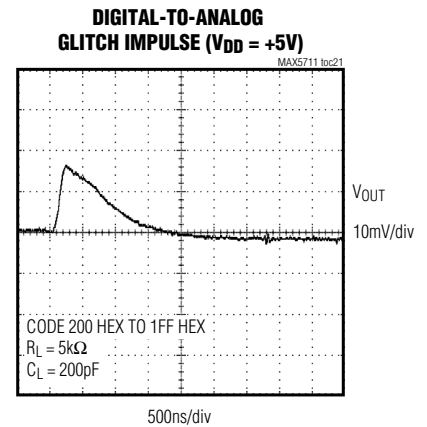
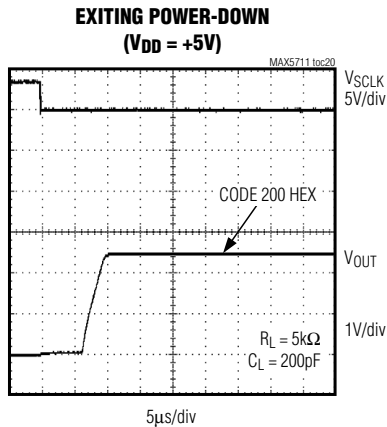
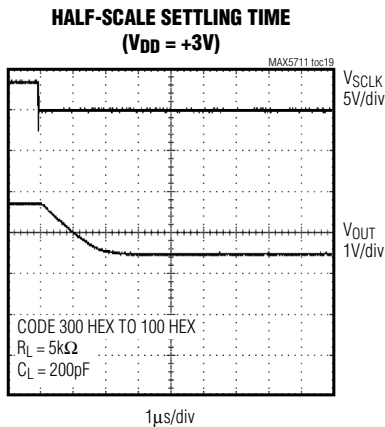
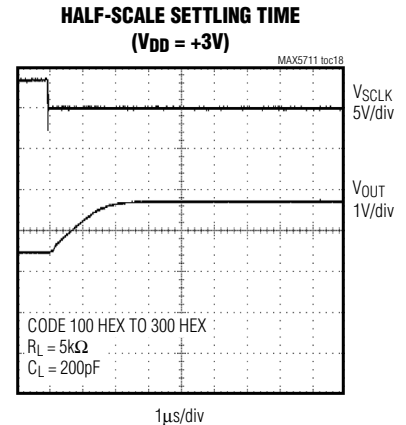
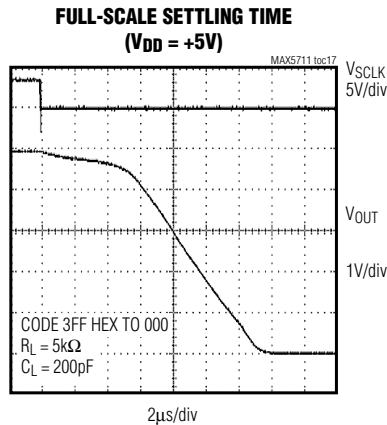
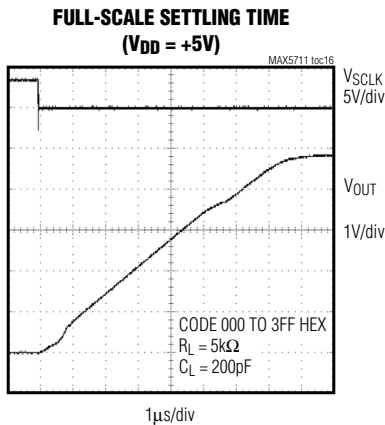
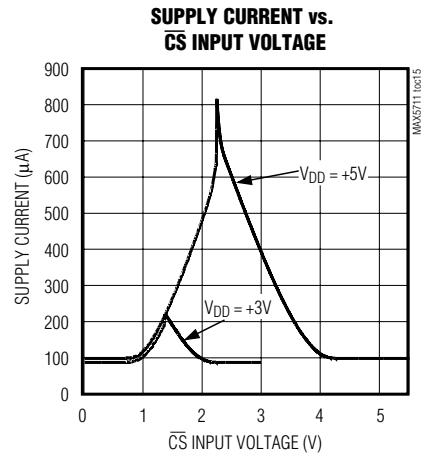
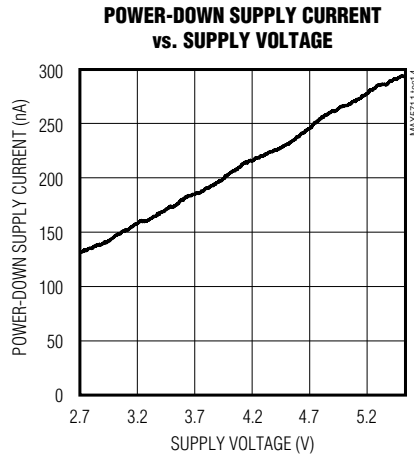
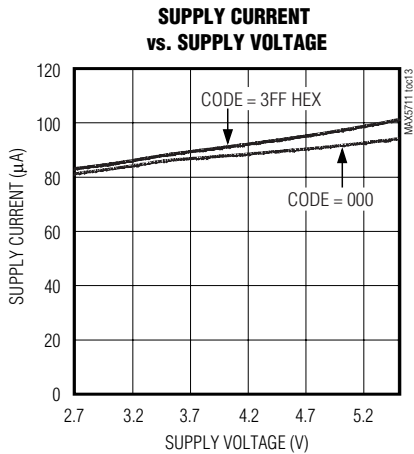

10-Bit, Low-Power, Rail-to-Rail Voltage-Output Serial DAC in SOT23

Typical Operating Characteristics (continued)

($T_A = +25^\circ\text{C}$, unless otherwise noted.)

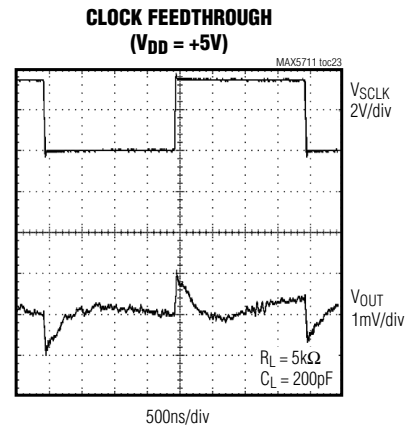
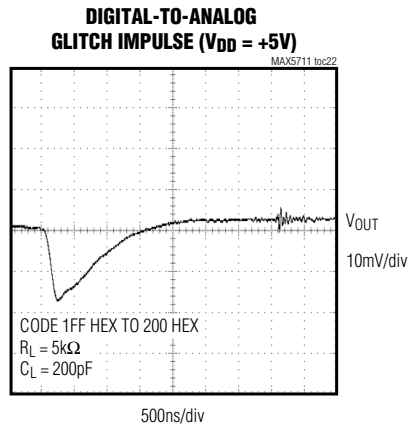

Pin Description

PIN	NAME	FUNCTION
1	V_{DD}	Power-Supply Input
2	GND	Ground
3	DIN	Serial Data Input
4	SCLK	Serial Clock Input
5	$\overline{\text{CS}}$	Active-Low Chip-Select Input
6	OUT	DAC Output Voltage

10-Bit, Low-Power, Rail-to-Rail Voltage-Output Serial DAC in SOT23

Detailed Description

The MAX5711 voltage-output, 10-bit DAC, offers a full 10-bit performance in a small 6-pin SOT23 package. The SOT23 footprint is less than 9mm². The MAX5711 has less than 1LSB differential nonlinearity error, ensuring monotonic performance. The device uses a simple 3-wire, SPI/QSPI/MICROWIRE and DSP-compatible serial interface that operates up to 20MHz. The MAX5711 incorporates three shutdown modes, making it ideal for low-power applications.

Analog Section

The MAX5711 consists of a resistor string, an output buffer, and a POR circuit. Monotonic digital-to-analog conversion is achieved using a resistor string architecture. Since V_{DD} is the reference for the MAX5711, the accuracy of the DAC depends on the accuracy of V_{DD}. The low bias current of the MAX5711 allows its power to be supplied by a voltage reference such as the MAX6030. The 10-bit DAC code is binary-unipolar with 1LSB = V_{DD}/1024.

Output Buffer

The DAC output buffer has a rail-to-rail output and is capable of driving a 5kΩ resistive load in parallel with a 200pF capacitive load. With a capacitive load of 200pF, the output buffer slews 0.5V/μs. With a 1/4FS to 3/4FS output transition, the amplifier output settles to 1/2LSB in less than 10μs when loaded with 5kΩ in parallel with 200pF. The buffer amplifier is stable with any combination of resistive loads greater than 5kΩ and capacitive loads less than 200pF.

Program the input register bits to power-down the device. The DAC registers are preserved during power-down and upon wake-up, the DAC output is restored to its pre-power-down voltage.

Power-On Reset

The MAX5711 has a POR circuit to set the DACs output to zero when V_{DD} is first applied. This ensures that unwanted DAC output voltages will not occur immediately following a system startup, such as after a loss of power. Upon initial power-up, an internal power-on reset circuit ensures that all DAC registers are cleared, the DAC is powered-down, and its output is terminated to GND by a 100kΩ resistor. An 8μs recovery time after issuing a wake-up command is needed before writing to the DAC registers.

Digital Section

3-Wire Serial Interface

The MAX5711 digital interface is a standard 3-wire connection compatible with SPI/QSPI/MICROWIRE/DSP interfaces. The chip-select input (\overline{CS}) frames the serial data loading at DIN. Immediately following \overline{CS} high-to-low transition, the data is shifted synchronously and latched into the input register on the falling edge of the serial clock input (SCLK). After 16 bits have been loaded into the serial input register, the serial input register transfers its contents to the DAC latch. \overline{CS} may then either be held low or brought high. \overline{CS} must be brought high for a minimum of 80ns before the next write sequence, since a write sequence is initiated on a

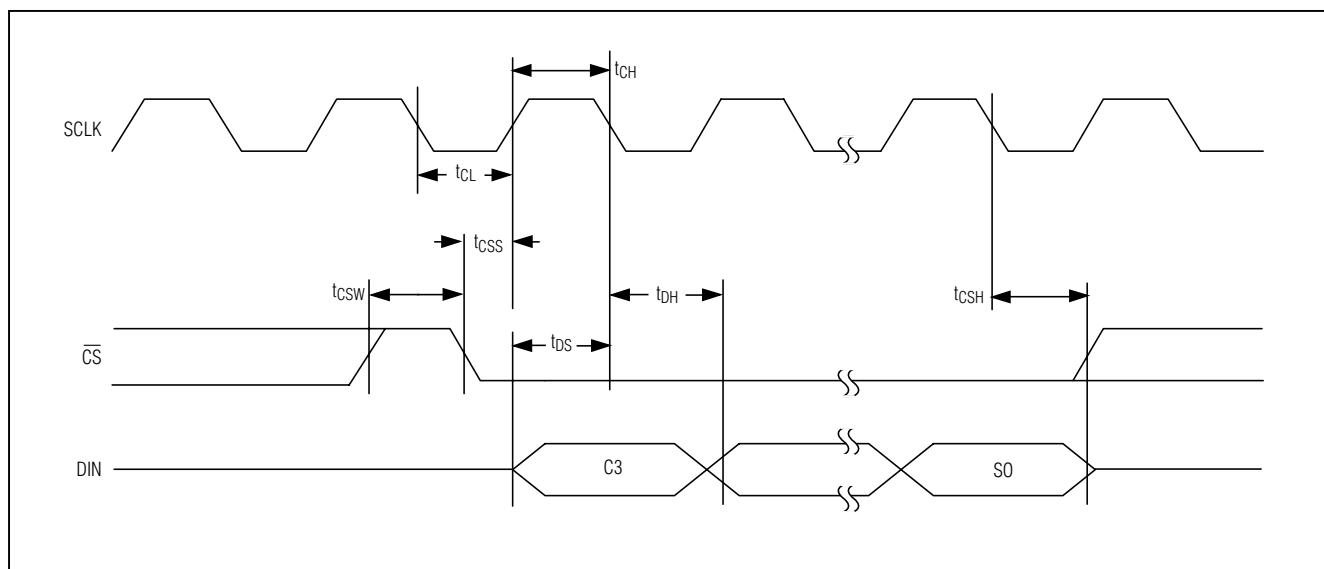

Figure 1. Timing Diagram

10-Bit, Low-Power, Rail-to-Rail Voltage-Output Serial DAC in SOT23

Table 1. Serial Interface Mapping

16-BIT SERIAL WORD														MODE	OUTPUT		
MSB										LSB							
C3	C2	C1	C0	D09	D08	D07	D06	D05	D04	D03	D02	D01	D00			S1	S0
0	0	0	0	10-Bit DAC Code										0	0	Set and Update DAC	$V_{OUT} = V_{DD} \times \text{CODE}/1024$
1	1	1	1	X	X	X	X	X	X	X	X	X	X	0	0	Wake-Up	Current DAC setting (initially 0)
1	1	1	1	X	X	X	X	X	X	X	X	X	X	0	1	Power-Down	Floating
1	1	1	1	X	X	X	X	X	X	X	X	X	X	1	0	Power-Down	1k Ω to GND
1	1	1	1	X	X	X	X	X	X	X	X	X	X	1	1	Power-Down	100k Ω to GND

X = Don't Care

falling edge of \overline{CS} . Not keeping \overline{CS} low during the first 15 SCLK cycles discards input data. The serial clock (SCLK) can idle either high or low between transitions. Figure 1 shows the complete 3-wire serial interface transmission. Table 1 lists serial-interface mapping. The first command after V_{DD} is applied must be the wake-up command.

Power-Down Modes

The MAX5711 includes three software-controlled power-down modes that reduce the supply current to below 1 μ A. In two of the three power-down modes, OUT is connected to GND through a resistor. Table 1 lists the three power-down modes of operation. When in power-down, the MAX5711 does not respond to the "set and update" command.

Applications Information

Device Powered by an External Reference

The MAX5711 generates an output voltage proportional to V_{DD} , coupling power-supply noise to the output. The circuit in Figure 2 rejects this power-supply noise by powering the device directly with a precision voltage reference, improving overall system accuracy. The MAX6030 (+3V, 75ppm) or the MAX6050 (+5V, 75ppm) precision voltage references are ideal choices due to the low-power requirements of the MAX5711. This solution is also useful when the required full-scale output voltage is less than the available supply voltages.

Digital Inputs and Interface Logic

The 3-wire digital interface for the MAX5711 is compatible with SPI, QSPI, MICROWIRE, and DSP. The three digital inputs (\overline{CS} , DIN, and SCLK) load the digital input serially into the DAC. All of the digital inputs include

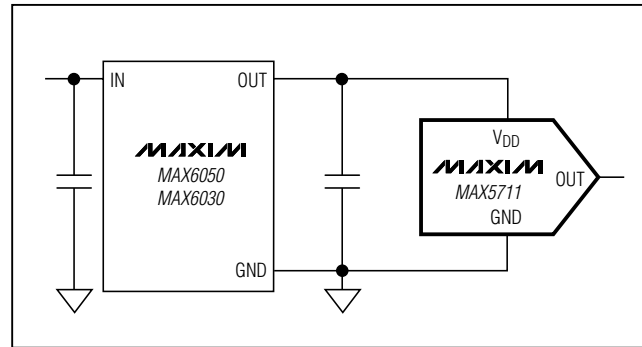

Figure 2. MAX5711 Powered By Reference

Schmitt-trigger buffers to accept slow-transition interfaces. This allows optocouplers to interface directly to the MAX5711 without additional external logic. The digital inputs are compatible with CMOS-logic levels.

Power-Supply Bypassing and Layout

Careful PC board layout is important for optimal system performance. Keep analog and digital signals separate to reduce noise injection and digital feedthrough. Use a ground plane to ensure that the ground return from GND to the supply ground is short and low impedance. Bypass V_{DD} with a 0.1 μ F capacitor to ground as close as possible to the device.

Chip Information

TRANSISTOR COUNT: 3856

PROCESS: BiCMOS

10-Bit, Low-Power, Rail-to-Rail Voltage-Output Serial DAC in SOT23

Package Information

MAX5711

SEE NOTE 5
EXAMPLE
TOP MARK

PIN 1
I.D. DOT
(SEE NOTE 6)

PIN #1

SYMBOL	MIN	MAX
A	0.90	1.45
A1	0.00	0.15
A2	0.90	1.30
b	0.35	0.50
C	0.08	0.20
D	2.80	3.00
E	2.60	3.00
E1	1.50	1.75
L	0.35	0.55
e	0.95 REF	
α	0°	10°

NOTES:
 1. ALL DIMENSIONS ARE IN MILLIMETERS.
 2. FOOT LENGTH MEASURED AT INTERCEPT POINT BETWEEN DATUM A & LEAD SURFACE.
 3. PACKAGE OUTLINE EXCLUSIVE OF MOLD FLASH & METAL BURR.
 4. PACKAGE OUTLINE INCLUSIVE OF SOLDER PLATING.
 5. PIN 1 IS LOWER LEFT PIN WHEN READING TOP MARK FROM LEFT TO RIGHT. (SEE EXAMPLE TOP MARK)
 6. PIN 1 I.D. DOT IS 0.3 MM Ø MIN. LOCATED ABOVE PIN 1.
 7. MEETS JEDEC MO178.

6LSOT23

MAXIM		
PROPRIETARY INFORMATION		
TITLE: PACKAGE OUTLINE, SOT-23, 6L		
APPROVAL	DOCUMENT CONTROL NO. 21-0058	REV E 1/1

Maxim cannot assume responsibility for use of any circuitry other than circuitry entirely embodied in a Maxim product. No circuit patent licenses are implied. Maxim reserves the right to change the circuitry and specifications without notice at any time.

Maxim Integrated Products, 120 San Gabriel Drive, Sunnyvale, CA 94086 408-737-7600 9