



Silicon Oscillator with Low-Power Frequency Switching and Reset Output

MAX7384

General Description

The MAX7384 dual-speed silicon oscillator replaces ceramic resonators, crystals, and crystal-oscillator modules as the primary and secondary clock source for microcontrollers in 3V, 3.3V, and 5V applications. The MAX7384 features a factory-programmed high-speed oscillator, a 32.768kHz oscillator, a clock-selector input, and a μP power-on-reset (POR) supervisor. The clock output can be switched at any time between the high-speed clock and the 32.768kHz clock for low-power operation. Switchover is synchronized internally to provide glitch-free clock switching.

Unlike typical crystal and ceramic-resonator oscillator circuits, the MAX7384 is resistant to vibration and EMI. The high-output-drive current and absence of high-impedance nodes makes the oscillator less susceptible to dirty or humid operating conditions. With a wide operating temperature range as standard, the MAX7384 is a good choice for demanding home appliance, industrial, and automotive environments.

The MAX7384 is available with factory-programmed frequencies ranging from 10MHz to 16MHz. See Table 1 for standard frequencies and contact the factory for custom frequencies. Refer to the MAX7378 data sheet for frequencies less than 10MHz.

The MAX7384 is available in an 8-pin $\mu\text{MAX}^{\text{®}}$ package. The MAX7384 standard operating temperature range is -40°C to $+125^{\circ}\text{C}$. See the *Applications Information* section for extended operating temperature range.

Applications

- White Goods
- Automotive
- Consumer Products
- Appliances and Controls
- Handheld Products
- Portable Equipment
- Microcontroller Systems

μMAX is a registered trademark of Maxim Integrated Products, Inc.

Pin Configuration appears at end of data sheet.

Features

- ◆ 2.7V to 5.5V Operation
- ◆ High-Speed Oscillator from 10MHz to 16MHz
Low-Speed 32kHz Oscillator
Glitch-Free Clock-Speed Switching
- ◆ Integrated POR
- ◆ $\pm 10\text{mA}$ Clock-Output Drive Capability
- ◆ 2.5% Initial Accuracy
- ◆ $\pm 50\text{ppm}/^{\circ}\text{C}$ Frequency Drift
- ◆ 50% Duty Cycle
- ◆ 5ns Output Rise and Fall Time
- ◆ Low Jitter: 80psp-p at 16MHz
- ◆ 4mA Operating Current at 16MHz
- ◆ $13\mu\text{A}$, 32kHz Operating Current
- ◆ -40°C to $+125^{\circ}\text{C}$ Temperature Range

Ordering Information

PART*	TEMP RANGE	PIN-PACKAGE	RESET OUTPUT
MAX7384A_ _ _	-40°C to $+125^{\circ}\text{C}$	8 μMAX	Active high push-pull
MAX7384B_ _ _	-40°C to $+125^{\circ}\text{C}$	8 μMAX	Active low push-pull
MAX7384C_ _ _	-40°C to $+125^{\circ}\text{C}$	8 μMAX	Open drain

*Standard version is shown in bold. The first letter after the part number designates the reset output option. Insert the letter corresponding to the desired reset threshold level from Table 1 in the next position. Insert the two-letter code from Table 2 in the remaining two positions for the desired frequency range. Table 1 and Table 2 are located at the end of the data sheet.

Typical Application Circuit

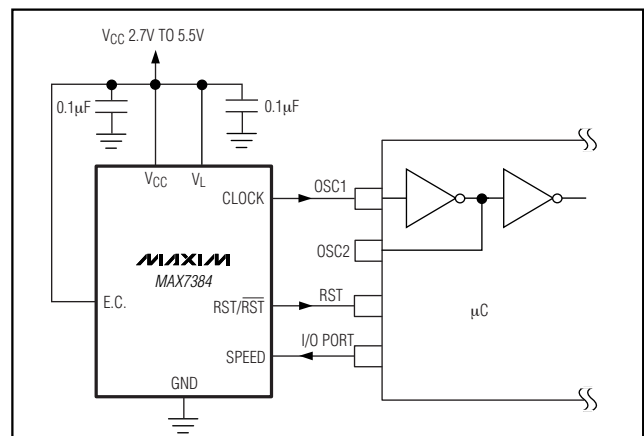

Silicon Oscillator with Low-Power Frequency Switching and Reset Output

ABSOLUTE MAXIMUM RATINGS

V_{CC} to GND-0.3V to +6.0V
 All Other Pins to GND.....-0.3V to (V_{CC} + 0.3V)
 CLOCK, RST Current±50mA
 Input Current (SPEED).....±50mA
 Continuous Power Dissipation (T_A = +70°C)
 8-Pin μMAX (derate 4.5mW/°C above +70°C) ...362mW (U8-1)

Operating Temperature Range-55°C to +135°C
 Junction Temperature+150°C
 Storage Temperature Range-65°C to +150°C
 Lead Temperature (soldering, 10s)+300°C

Stresses beyond those listed under "Absolute Maximum Ratings" may cause permanent damage to the device. These are stress ratings only, and functional operation of the device at these or any other conditions beyond those indicated in the operational sections of the specifications is not implied. Exposure to absolute maximum rating conditions for extended periods may affect device reliability.

ELECTRICAL CHARACTERISTICS

(Typical Operating Circuit, V_{CC} = 2.7V to 5.5V, V_L = V_{CC}, T_A = -40°C to +125°C. Typical values are at V_{CC} = 5.0V, T_A = +25°C, unless otherwise noted.) (Note 1)

PARAMETER	SYMBOL	CONDITIONS	MIN	TYP	MAX	UNITS
Operating Supply Voltage	V _{CC}		2.7		5.5	V
Operating Supply Current	I _{CC}	f _{CLOCK} = 16MHz, T _A = -40°C to +125°C, no load			8.7	mA
		f _{CLOCK} = 14.7456MHz, T _A = -40°C to +125°C, no load			8.0	
		f _{CLOCK} = 12MHz, T _A = -40°C to +125°C, no load			6.5	
		f _{CLOCK} = 11.0592MHz, T _A = -40°C to +125°C, no load			6.0	
		f _{CLOCK} = 10MHz, T _A = -40°C to +125°C, no load			5.4	
		f _{CLOCK} = 32.768kHz, T _A = -40°C to +125°C, no load		13	25	μA
LOGIC INPUTS (SPEED)						
Input High Voltage	V _{IH}		0.7 x V _{CC}			V
Input Low Voltage	V _{IL}		0.3 x V _{CC}			V
Input Current	I _{IN}	V _{CC} = SPEED = 5.5V		2		μA
CLOCK OUTPUT						
Output High Voltage	V _{OH}	V _L = 4.5V, I _{SOURCE} = 7.0mA	V _L - 0.4			V
		V _L = 2.7V, I _{SOURCE} = 2.0mA				
Output Low Voltage	V _{OL}	V _L = 4.5V, I _{SINK} = 20mA			0.4	V
		V _L = 2.7V, I _{SINK} = 10mA				
Initial Fast Clock Frequency Accuracy	f _{CLOCK}	V _{CC} = 5V, T _A = +25°C, deviation from selected frequency	-2.5		+2.5	%
		V _{CC} = 2.7V to 5.5V, T _A = +25°C, deviation from selected frequency	-5		+3.5	
Fast Clock Temperature Coefficient		T _A = -40°C to +125°C		±50	±350	ppm/°C

Silicon Oscillator with Low-Power Frequency Switching and Reset Output

MAX7384

ELECTRICAL CHARACTERISTICS (continued)

(Typical Operating Circuit, $V_{CC} = 2.7V$ to $5.5V$, $V_L = V_{CC}$, $T_A = -40^{\circ}C$ to $+125^{\circ}C$. Typical values are at $V_{CC} = 5.0V$, $T_A = +25^{\circ}C$, unless otherwise noted.) (Note 1)

PARAMETER	SYMBOL	CONDITIONS		MIN	TYP	MAX	UNITS
Slow Clock Frequency	f _{CLOCK}	$V_{CC} = 5V$, $T_A = +25^{\circ}C$		32.268	32.768	33.268	kHz
		$V_{CC} = 2.7V$ to $5.5V$, $T_A = +25^{\circ}C$		31.768	32.768	33.768	
Slow Clock Temperature Coefficient		$T_A = -40^{\circ}C$ to $+125^{\circ}C$			±50	±325	ppm/ $^{\circ}C$
Duty Cycle		(Note 2)		40	50	60	%
Output Jitter		Observation of 16MHz for 20s using a 12GHz oscilloscope			80		psp-p
Output Rise Time	t _R	10% to 90%			5		ns
Output Fall Time	t _F	90% to 10%			5		ns
Power-On-Reset Threshold	V _{TH}	V _{CC} rising, deviation from nominal threshold	$T_A = +25^{\circ}C$	-2		+2	%
			$T_A = -40^{\circ}C$ to $+125^{\circ}C$	-5		+5	
Power-On-Reset Hysteresis	V _{HYST}	Difference between rising and falling thresholds			1		%
Power-On-Reset Delay	PORdly	V_{CC} rising from 0 to 5V in 1μs at $+25^{\circ}C$			122		μs
RESET OUTPUT							
Output High Voltage (Note 3)	V _{OH}	$V_L = 4.5V$, I _{SOURCE} = 7.0mA		$V_{CC} - 0.4$			V
		$V_L = 2.7V$, I _{SOURCE} = 2.0mA		$V_{CC} - 0.4$			
Output Low Voltage	V _{OL}	$V_L = 4.5V$, I _{SINK} = 20mA				0.4	V
		$V_L = 2.7V$, I _{SOURCE} = 10mA				0.4	

Note 1: All parameters tested at $T_A = +25^{\circ}C$. Specifications over temperature are guaranteed by design.

Note 2: Guaranteed by design. Not production tested.

Note 3: For push-pull output only.

Silicon Oscillator with Low-Power Frequency Switching and Reset Output

Typical Operating Characteristics

($V_{CC} = V_L = 5V$, $T_A = +25^\circ C$, frequency = 10MHz, unless otherwise noted.)

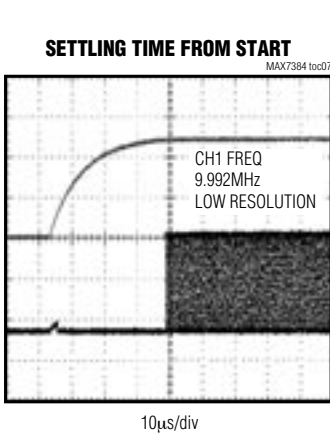
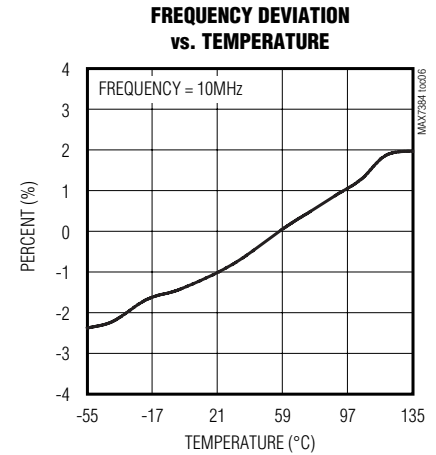
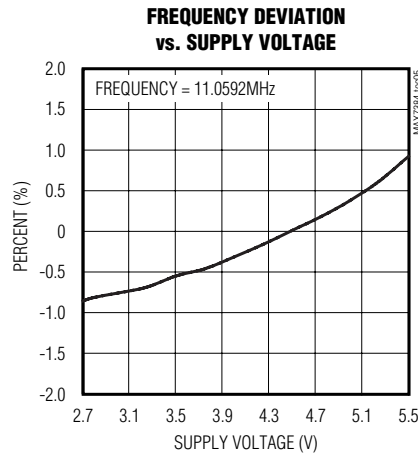
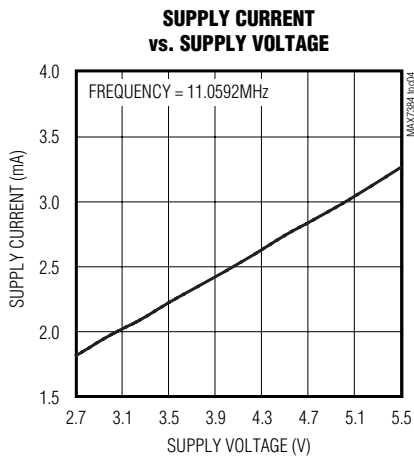
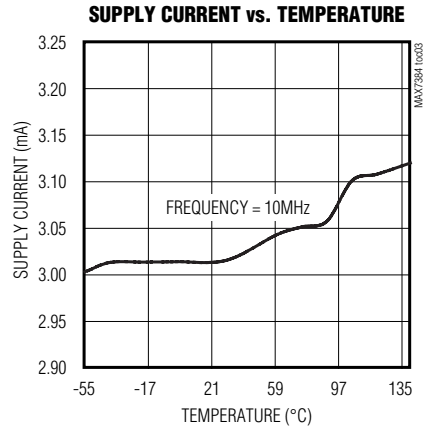
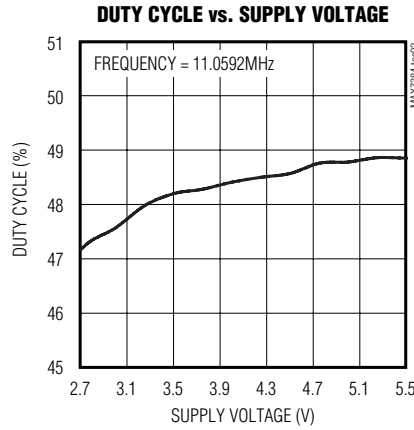
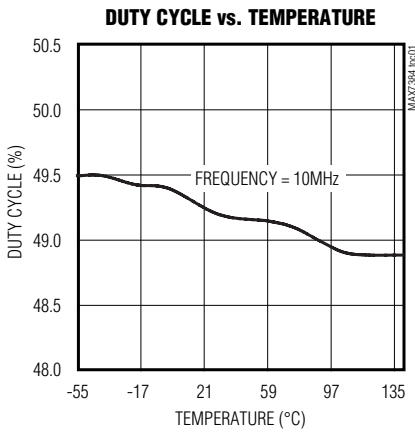

CHANNEL 1 = CLOCK, CHANNEL 2 = V_{CC}

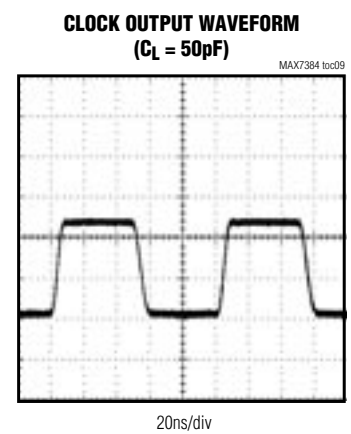
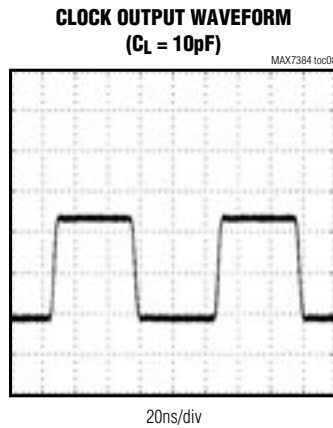

Silicon Oscillator with Low-Power Frequency Switching and Reset Output

MAX7384

Typical Operating Characteristics (continued)

($V_{CC} = V_L = 5V$, $T_A = +25^\circ C$, frequency = 10MHz, unless otherwise noted.)

CLOCK OUTPUT WAVEFORM
($C_L = 100pF$)

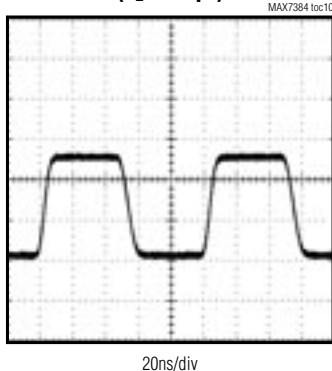

MAXIMUM TRANSIENT DURATION vs. RESET THRESHOLD OVERDRIVE

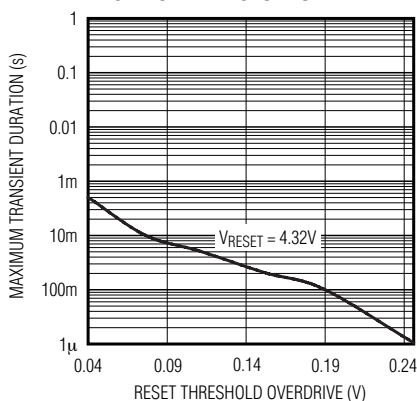

HIGH-SPEED TO LOW-SPEED TRANSITION

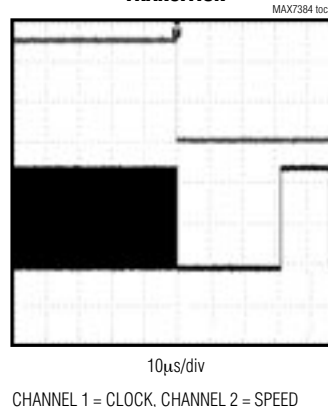

HIGH-SPEED TO LOW-SPEED TRANSITION

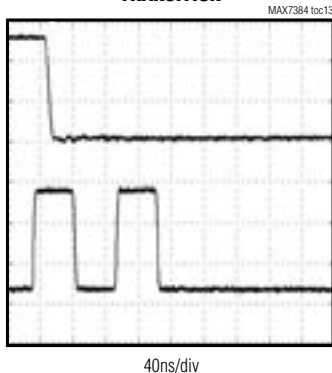

LOW-SPEED TO HIGH-SPEED TRANSITION

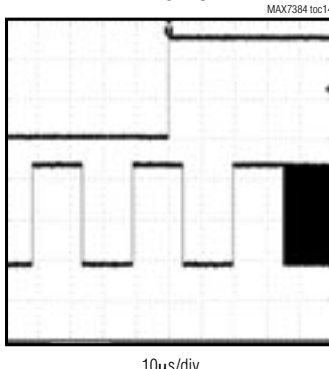

LOW-SPEED TO HIGH-SPEED TRANSITION



SUPPLY CURRENT vs. FREQUENCY

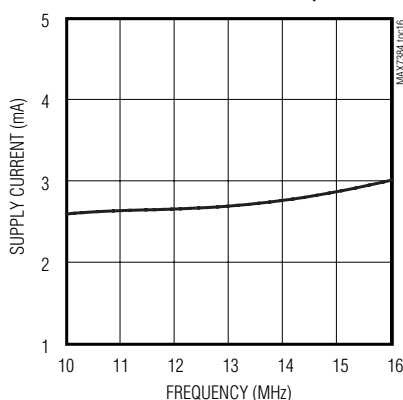

Silicon Oscillator with Low-Power Frequency Switching and Reset Output

Pin Description

PIN	NAME	FUNCTION
1	V _{CC}	Positive Supply Voltage. Bypass V _{CC} to GND with a 0.1μF capacitor.
2	V _L	Output Supply Voltage. Bypass V _L to GND with a 0.1μF capacitor. V _L must be connected to V _{CC} .
3	SPEED	Clock-Speed Select Input. Drive SPEED low to select the 32kHz fixed frequency. Drive SPEED high to select factory-trimmed frequency.
4	RST	Reset Output. Open-drain or push-pull output. See the <i>Ordering Information</i> .
5	CLOCK	Push-Pull Clock Output
6	GND	Ground
7	E.C.	Externally Connected. Connect to V _{CC} .
8	N.C.	No Connection. Not internally connected.

Detailed Description

The MAX7384 is a dual-speed clock generator with integrated reset for microcontrollers (μCs) and UARTs in 3V, 3.3V, and 5V applications. The MAX7384 is a replacement for crystal-oscillator modules, crystals, or ceramic resonators and a system reset IC. The high-speed clock frequency and reset threshold voltage are factory trimmed to specific values (see Table 1). A variety of popular standard frequencies are available. The low-speed clock frequency is fixed at 32.768kHz; see Table 2. No external components are required for setting or adjusting the frequency.

Oscillator

The push-pull clock output drives a load to within 400mV of either supply rail. The clock output remains stable over the full operating voltage range and does not generate short output cycles during either power-on or changing of the frequency. A typical oscillating start-up is shown in the *Typical Operating Characteristics*.

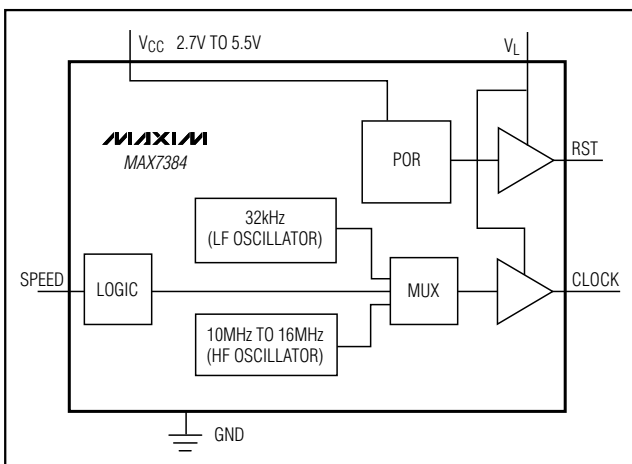

Figure 1. Functional Diagram

Clock-Speed Selection

Drive SPEED low to select slow clock speed (nominally 32.768kHz) or high to select full clock speed. SPEED can be connected to V_{CC} or to GND to select fast or slow clock speed, or connected to a logic output (such as a μP GPIO port) used to change clock speed on the fly. If SPEED is connected to a μP GPIO port, connect a pullup or pulldown resistor to set the clock to the preferred speed on power-up. SPEED input bias current is 2μA (max), so a resistor value as high as 500kΩ can be used.

Applications Information

Interfacing to a Microcontroller Clock Input

The MAX7384 clock output is a push-pull, CMOS, logic output that directly drives a μP or μC clock input. There are no impedance-matching issues when using the MAX7384. Refer to the microcontroller data sheet for clock input compatibility with external clock signals. The MAX7384 requires no biasing components or load capacitance. When using the MAX7384 to retrofit a crystal oscillator, remove all biasing components from the oscillator input.

Reset Output

The MAX7384 is available with three reset output stage options: push-pull active low, push-pull active high, and open-drain active low. RST is asserted when the monitored input (V_{CC}) drops below the internal V_{TH-} threshold and remains asserted for 120μs after the monitored input exceeds the internal V_{TH+} threshold. The open-drain RST output requires an external pullup resistor.

Output Jitter

The MAX7384's jitter performance is given in the *Electrical Characteristics* table as a peak-to-peak value obtained by observing the output of the MAX7384 for

Silicon Oscillator with Low-Power Frequency Switching and Reset Output

MAX7384

20s with a 12GHz oscilloscope. Jitter measurements are approximately proportional to the output period of the device. Thus, a 10MHz device has approximately twice the jitter value of a 20MHz device. The jitter performance of all clock sources degrades in the presence of mechanical and electrical interference. The MAX7384 is relatively immune to vibration, shock, and EMI influences and thus provides a considerably more robust clock source than crystal or ceramic resonator-based oscillator circuits.

Initial Power-Up and Operation

An internal power-up reset asserts RST until the supply voltage has risen above the power-on-reset threshold (V_{TH+}).

RST holds the microcontroller in a reset condition until 120 μ s after V_{CC} has risen above V_{TH+} . This reset delay ensures that the clock output and the microcontroller's internal clock circuits have stabilized before the system is allowed to start. Typical microcontroller reset delay ranges from 1ms to 250ms to allow a slow crystal oscillator circuit to start up. The MAX7384 has a fast startup, eliminating the need for such a long reset delay.

Extended Temperature Operation

The MAX7384 was tested to +135°C during product characterization and shown to function normally at this temperature (see the *Typical Operating Characteristics*). However, production test and qualification is only performed from -40°C to +125°C at this time. Contact the factory if operation outside this range is required.

Power-Supply Considerations

The MAX7384 operates with a 2.7V and 5.5V power-supply voltage. V_{CC} provides power to the the internal circuitry and V_L supplies power to the clock and reset outputs. Good power-supply decoupling is needed to maintain the power-supply rejection performance of the MAX7384. Bypass both V_{CC} and V_L to GND with a 0.1 μ F surface-mount ceramic capacitor. Mount the bypassing capacitors as close to the device as possible. Use a larger value bypass capacitor if the MAX7384 is to operate with a large capacitive load. Use a bypass capacitor value of at least 1000 times that of the output load capacitance.

Table 1. Standard Reset Threshold Levels

SUFFIX	RESET THRESHOLD (V)	
X	2.50	
V	2.71	
R	2.89	Standard value
Q	3.13	
P	3.34	
N	3.44	
J	3.96	
M	4.38	Standard value

Contact factory for nonstandard reset threshold options.

Table 2. Standard Frequencies

SUFFIX	STANDARD FREQUENCY (MHz)
UK	10
UT	11.0592
VB	12
VT	14.7456
WB	16

For all other frequency options, contact factory.

Table 3. Standard Part Numbers

PART	RESET OUTPUT TYPE	RESET THRESHOLD (V)	FREQUENCY (MHz)
MAX7384CRUK	Open drain	2.89	10
MAX7384CRUT	Open drain	2.89	11.0592
MAX7384CRVB	Open drain	2.89	12
MAX7384CRVT	Open drain	2.89	14.7456
MAX7384CRWB	Open drain	2.89	16
MAX7384CMUK	Open drain	4.38	10
MAX7384CMUT	Open drain	4.38	11.0592
MAX7384CMVB	Open drain	4.38	12
MAX7384CMVT	Open drain	4.38	14.7456
MAX7384CMWB	Open drain	4.38	16

Silicon Oscillator with Low-Power Frequency Switching and Reset Output

Chip Information

TRANSISTOR COUNT: 2937

PROCESS: BiCMOS

Pin Configuration

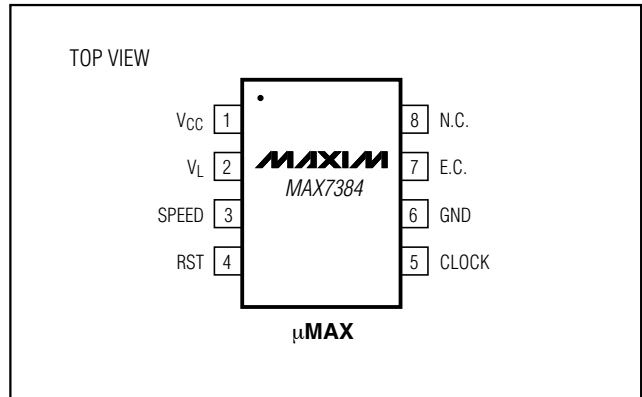

Silicon Oscillator with Low-Power Frequency Switching and Reset Output

Package Information

(The package drawing(s) in this data sheet may not reflect the most current specifications. For the latest package outline information, go to www.maxim-ic.com/packages.)

MAX7384

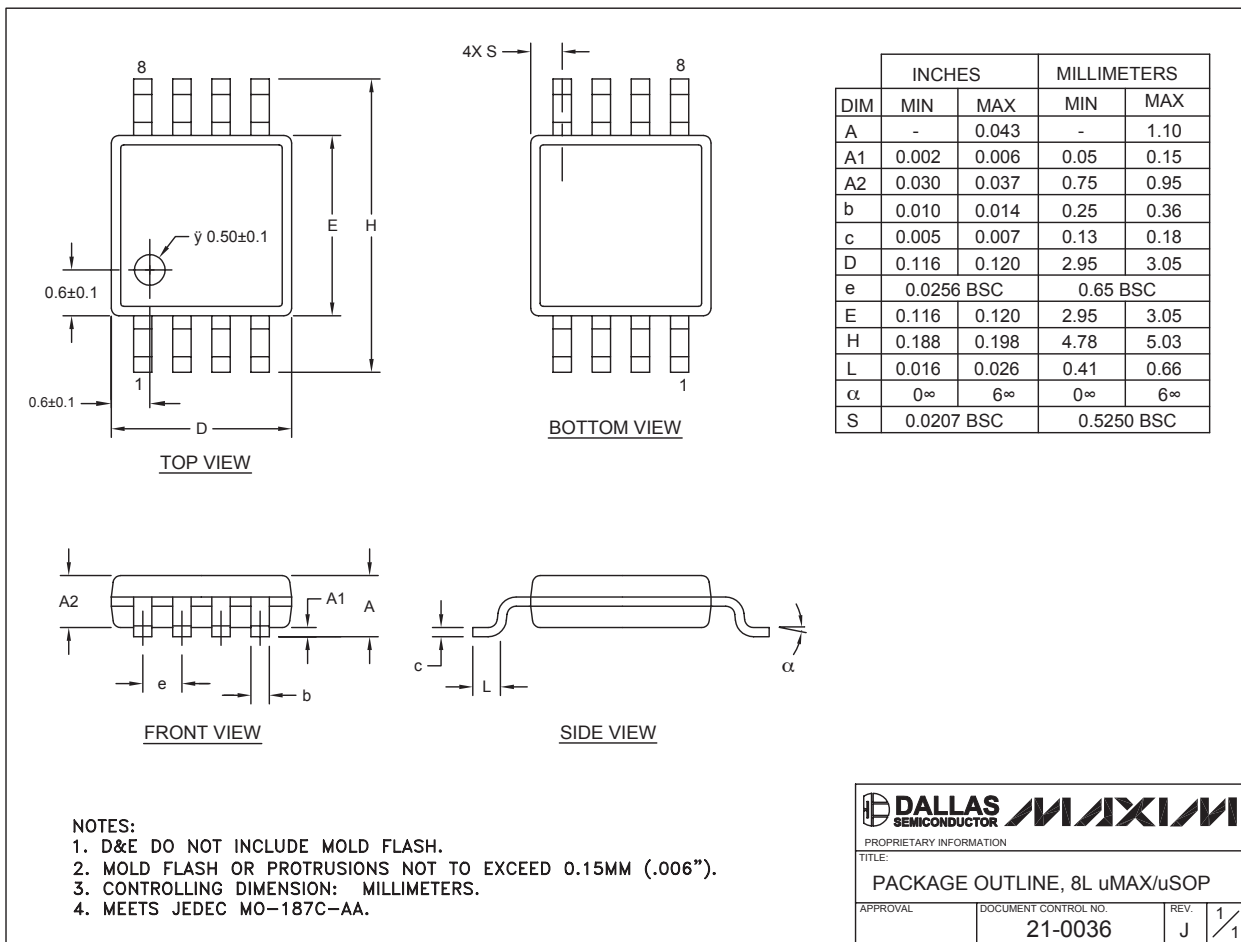

Maxim cannot assume responsibility for use of any circuitry other than circuitry entirely embodied in a Maxim product. No circuit patent licenses are implied. Maxim reserves the right to change the circuitry and specifications without notice at any time.

Maxim Integrated Products, 120 San Gabriel Drive, Sunnyvale, CA 94086 408-737-7600 9