

8-bit Original Microcontroller

CMOS

F²MC-8L MB89530 Series

MB89537/537C/538/538C MB89F538L/P538/PV530

■ DESCRIPTION

The MB89530 series is a one-chip microcontroller featuring the F²MC-8L core supporting low-voltage and high-speed operation. Built-in peripheral functions include timers, serial interface, A/D converter, and external interrupt. This product is an ideal general-purpose one-chip microcontroller for a wide variety of applications from household to industrial equipment, as well as use in portable devices.

■ FEATURES

- Wide range of package options
 - QFP package (1mm pitch)
 - Two types of LQFP packages (0.5mm pitch, 0.65mm pitch)
 - SH-DIP package
 - BCC package (0.5mm pitch)
- Low voltage, high-speed operating capability
 - Minimum instruction execution time 0.32 μ s (at base oscillator 12.5MHz)
- F²MC-8L CPU Core
 - Instruction set optimized for controller operation
 - Multiplication/division instructions
 - 16-bit calculation
 - Branching instructions with bit testing
 - Bit operation instructions, etc.
- Five timer systems
 - 8-bit PWM timer with 2 channels (usable as either interval timer or PWM timer)
 - Pulse width count timer (supports continuous measurement or remote control receiving applications)
 - 16-bit timer counter
 - 21-bit time base timer
 - Watch prescaler (17-bit)
- UART
 - Synchronous or asynchronous operation, switchable
- 2 serial interfaces (serial I/O)
 - Selection of transfer direction (specify MSB first or LSB first) for communication with a variety of devices

(Continued)

■ PACKAGES

64-pin, Plastic SH-DIP

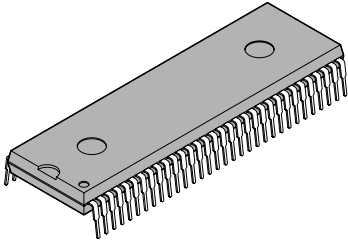

(DIP-64P-M01)

64-pin, Plastic LQFP

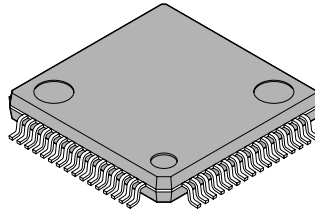

(FPT-64P-M03)

64-pin, Plastic QFP

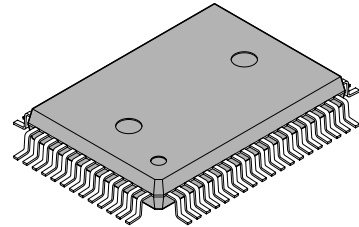

(FPT-64P-M06)

64-pin, Plastic LQFP

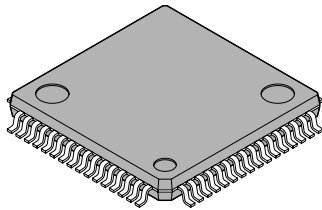

(FPT-64P-M09)

64-pin, Ceramic MDIP

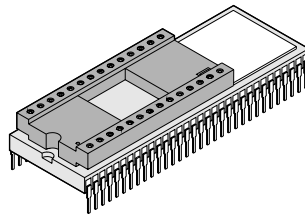

(MDP-64C-P02)

64-pin, Ceramic MQFP

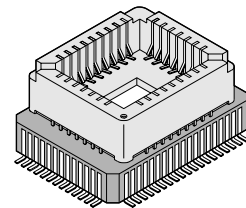

(MQP-64C-P01)

64-pin, Plastic BCC

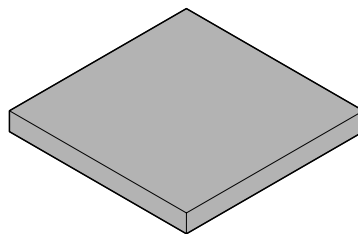

(LCC-64P-M19)
(LCC-64P-M16)

MB89530 Series

(Continued)

Part number	MB89537/537C	MB89538/538C	MB89F538L	MB89P538	MB89PV530	
Parameter						
Peripheral functions	Pulse width count timer	8-bit one-shot timer operation (supports underflow output, operating clock period : 1, 4, 32 t_{inst}^{*3} , external) 8-bit reload timer operation (supports square wave output, operating clock period : 1, 4, 32 t_{inst}^{*3} , external) 8-bit pulse width measurement operation (continuous measurement, H width measurement, L width measurement, rise-to-rise, fall-to-fall, H width measurement and rise-to-rise)				
	16-bit timer/counter	16-bit timer operation (operating clock period : 1 t_{inst}^{*3} , external) 16-bit event counter operation (select rising, falling, or both edges) 16-bit \times 1 ch				
	Serial I/O	8 bit length, Selection of LSB first or MSB first, Transfer clock (2, 8, 32 t_{inst}^{*3} , external)				
	UART/SIO	CLK synchronous/CLK asynchronous data transfer capability (8, 9 bit with parity bit, or 7,8 bit without parity bit) . Built-in baud rate generator provides selection of 14 baud rate settings.				
	UART	CLK synchronous/CLK asynchronous data transfer capability (4, 6, 7, 8 bit with parity bit, or 5, 7, 8, 9 bit without parity bit) . Built-in baud rate generator provides selection of 14 baud rate settings. External clock output, 2-channel 8-bit PWM timer output also available for baud rate settings.				
	External interrupt 1	Single-clock : 4-channel independent, dual-clock : 3-channel independent Selection of rising, falling, or both edge detection. Can be used for recovery from standby mode (edge detection also available in stop mode) .				
	External interrupt 2	Except for MB89F538L : 8-channel independent L level detection, MB89F538L : 7-channel independent L level detection Can be used for recovery from standby mode.				
	6-bit PPG, 12-bit PPG	Can generate square wave signals with programmable period. 6-bit \times 1 channel or 12-bit \times 2 channels.				
	I ² C bus interface	1-channel , compatible with Intel System Administrator bus version 1.0 and Philips I ² C specifications. 2-line communications (on MB89PV530/P538/F538L/537C/538C)				
	A/D converter	10-bit resolution \times 8 channels. A/D conversion functions (conversion time : 60 t_{inst}^{*3}) Supports repeated calls from external clock (except for MB89F538L) Supports repeated calls from internal clock. Standard voltage input provided (AVR)				
Standby modes (power saving modes)	Sleep mode, stop mode, sub clock mode, watch mode.					
Process	CMOS					

*1 : Depends on operating frequency.

*2 : Using external ROM and MBM27C512.

*3 : t_{inst} represents instruction execution time. This can be selected as 1/4, 1/8, 1/16, 1/64 of the main clock cycle or 1/2 of the sub clock cycle.

Note : MB89537/538 have no built-in I²C functions.

To use I²C functions, choose the MB89PV530/P538/F538L/MB89537C/538C.

MB89530 Series

■ MODEL DIFFERENCES AND SELECTION CONSIDERATIONS

Part number Package	MB89537/537C	MB89538/538C	MB89F538L	MB89P538	MB89PV530
DIP-64P-M01	O	O	O	O	X
FPT-64P-M03	O	O	X	X	X
FPT-64P-M06	O	O	O	O	X
FPT-64P-M09	O	O	O	O	X
LCC-64P-M19	X	X	O	X	X
LCC-64P-M16	X	X	X	O*	X
MDP-64C-P02	X	X	X	X	O
MQP-64C-P01	X	X	X	X	O

O : Model-package combination available

X : Model-package combination not available

* : Only for ES

Conversion sockets for pin pitch conversion (manufactured by Sunhayato Corp.) can be used.

Contact : Sunhayato Corp. : TEL : +81-3-3984-7791

FAX : +81-3-3971-0535

E-mail : adapter@sunhayato.co.jp

■ DIFFERENCES AMONG PRODUCTS

1. Memory Capacity

When this product is used in a piggy-back or other evaluation configuration, it is necessary to carefully confirm the differences between the model being used and the product it is evaluating. Particular attention should be given to the following (see "■ CPU core 1. Memory Space").

- The program ROM area starts from address 4000H on the MB89P538, MB89F538L and MB89PV530 models.
- Note upper limits on RAM, such as stack areas, etc.

2. Current Consumption

- On the MB89PV530, the additional current consumed by the EPROM is added at the connecting socket on the back side.
- When operating at low speed, the current consumption in the one-time PROM or EPROM models is greater than on the mask ROM models. However, current consumption in sleep or stop modes is identical.

For details, refer to "■ ELECTRICAL CHARACTERISTICS".

3. Mask Options

The options available for use, and the method of specifying options, differ according to the model. Before use, check the "■ MASK OPTIONS" specification section.

4. Wild Register Functions

The following table shows areas in which wild register functions can be used.

Wild Register Usage Areas

Part number	Address space
MB89PV530	4000 _H to FFFF _H
MB89P538	4000 _H to FFFF _H
MB89F538L	4000 _H to FFFF _H
MB89537/537C	8000 _H to FFFF _H
MB89538/538C	4000 _H to FFFF _H

MB89530 Series

PIN ASSIGNMENTS

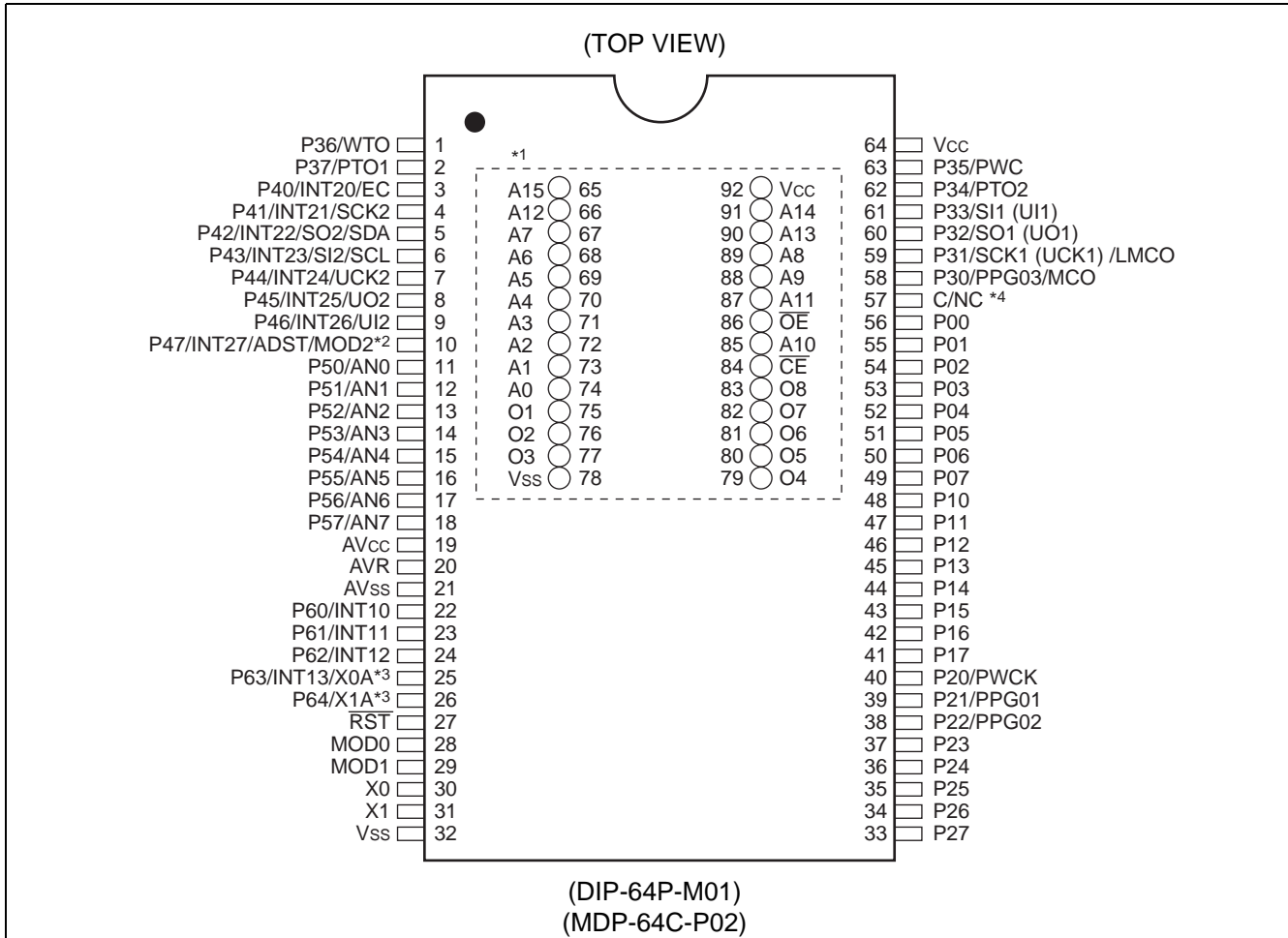

*1 : Package top pin assignments (MB89PV530 only)

Pin no.	Pin name	Pin no.	Pin name	Pin no.	Pin name	Pin no.	Pin name
65	A15	73	A1	81	O6	89	A8
66	A12	74	A0	82	O7	90	A13
67	A7	75	O1	83	O8	91	A14
68	A6	76	O2	84	CE	92	Vcc
69	A5	77	O3	85	A10		
70	A4	78	Vss	86	OE		
71	A3	79	O4	87	A11		
72	A2	80	O5	88	A9		

- N.C. : Internal connection only. Not for use.
- *2 : Pin 10 is P47/INT27/ADST pins except for MB89F538L and MOD2 pin for MB89F538L.
- *3 : Pin 25 and 26 are P63/INT13, P64 pins for single-clock and X0A, X1A pins for dual-clock.
- *4 : The function of pin 57 depends on the model. For details, see "PIN DESCRIPTIONS" and "HANDLING DEVICES".

(Continued)

(TOP VIEW)

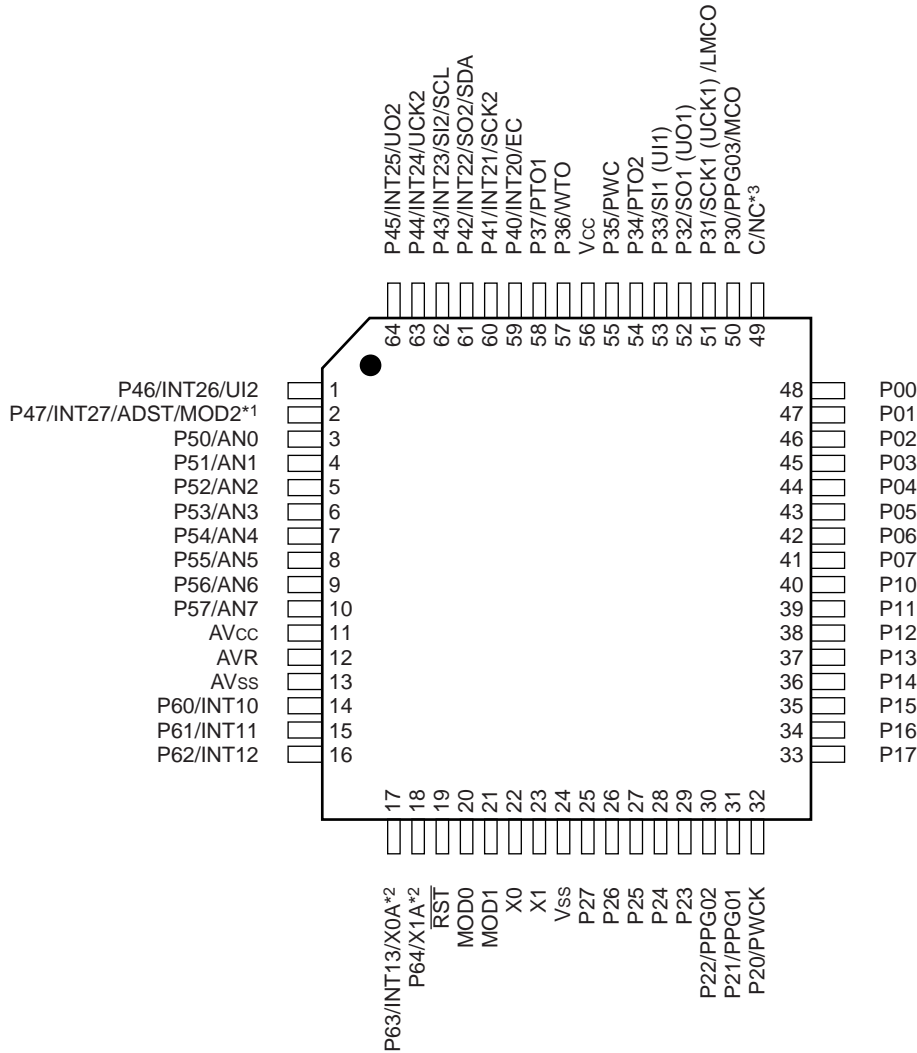

(FPT-64P-M03)
(FPT-64P-M09)

*1 : Pin 2 is P47/INT27/ADST pins except for MB89F538L and MOD2 pin for MB89F538L.

*2 : Pin 17 and 18 are P63/INT13, P64 pins for single-clock and X0A, X1A pins for dual-clock.

*3 : The function of pin 49 depends on the model. For details, see "PIN DESCRIPTIONS" and "HANDLING DEVICES".

(Continued)

MB89530 Series

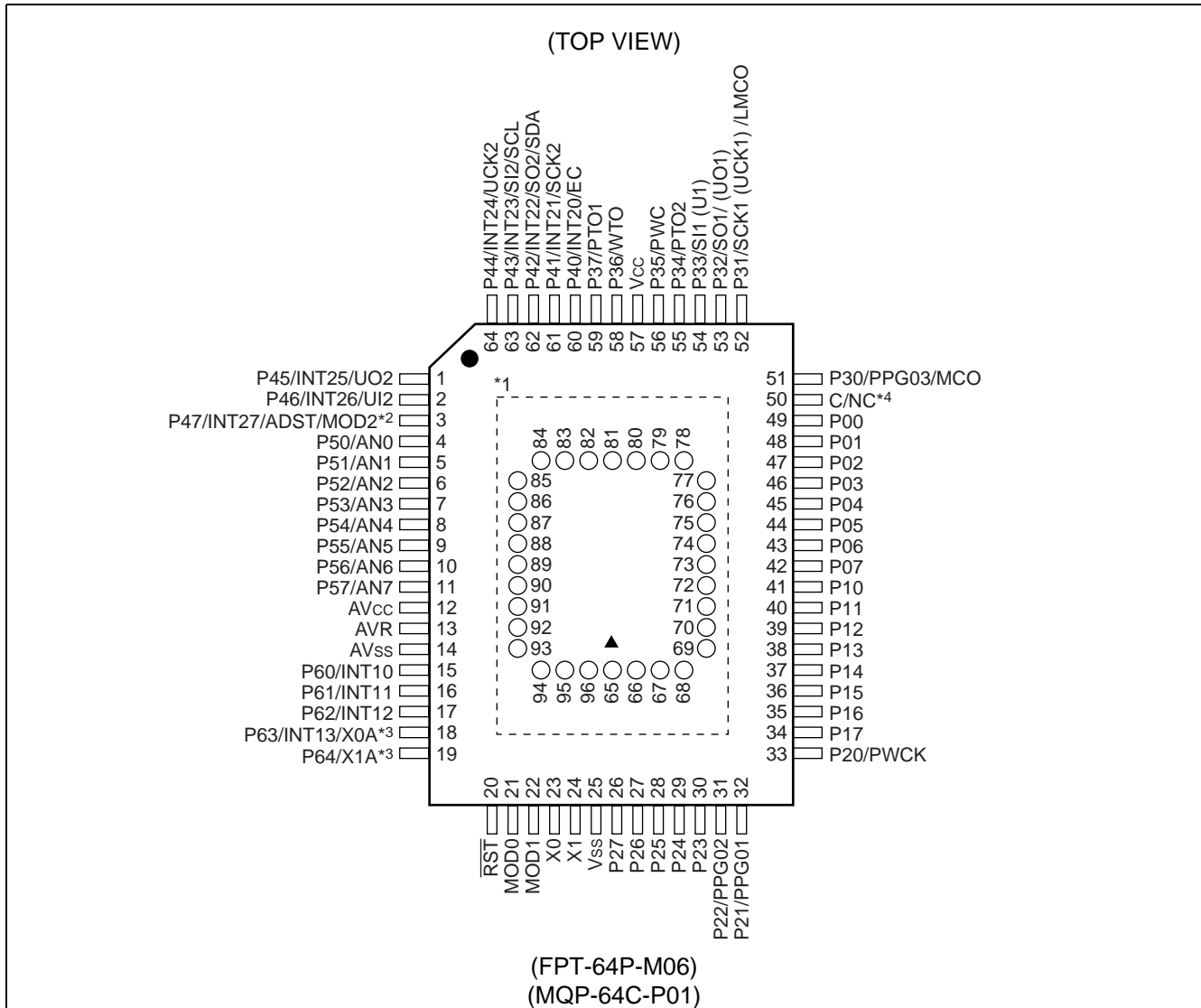

*1 : Package top pin assignments (MB89PV530 only)

Pin no.	Pin name	Pin no.	Pin name	Pin no.	Pin name	Pin no.	Pin name
65	N.C.	73	A2	81	N.C.	89	OE
66	A15	74	A1	82	O4	90	N.C.
67	A12	75	A0	83	O5	91	A11
68	A7	76	N.C.	84	O6	92	A9
69	A6	77	O1	85	O7	93	A8
70	A5	78	O2	86	O8	94	A13
71	A4	79	O3	87	CE	95	A14
72	A3	80	Vss	88	A10	96	Vcc

N.C. : Internal connection only. Not for use.

*2 : Pin 3 is P47/INT27/ADST pins except for MB89F538L and MOD2 pin for MB89F538L.

*3 : Pin 18 and 19 are P63/INT13, P64 pins for single-clock and X0A, X1A pins for dual-clock.

*4 : The function of pin 50 depends on the model. For details, see "■PIN DESCRIPTIONS" and "■HANDLING DEVICES".

(Continued)

MB89530 Series

■ PIN DESCRIPTIONS

Pin no.			Pin name	I/O circuit type	Function
SH-DIP*1 MDIP*2	QFP*3 MQFP*4	LQFP*5 BCC*6			
30	23	22	X0	A	Connecting pins to crystal oscillator circuit or other oscillator circuit. The X0 pin can connect to an external clock. In that case, X1 is left open.
31	24	23	X1		
28	21	20	MOD0	B	Input pins for memory access mode setting. Connect directly to Vss.
29	22	21	MOD1		
27	20	19	$\overline{\text{RST}}$	C	Reset I/O pin. This pin has pull-up resistance with CMOS I/O or hysteresis input. At an internal reset request, an 'L' signal is output. An 'L' level input initializes the internal circuits.
56 to 49	49 to 42	48 to 41	P00 to P07	D	General purpose I/O ports.
48 to 41	41 to 34	40 to 33	P10 to P17	D	General purpose I/O ports.
40	33	32	P20/PWCK	E	General purpose I/O port.Resource I/O pin (hysteresis input).Hysteresis input. This pin also functions as a PWC input.
39	32	31	P21/ PPG01	D	General purpose I/O port.This pin also functions as the PPG01 output.
38	31	30	P22/ PPG02	D	General purpose I/O port.This pin also functions as the PPG02 output.
37	30	29	P23	D	General purpose I/O port.
36	29	28	P24	D	General purpose I/O port.
35	28	27	P25	D	General purpose I/O port.
34	27	26	P26	D	General purpose I/O port.
33	26	25	P27	D	General purpose I/O port.
58	51	50	P30/ PPG03/ MCO	D	General purpose I/O port.This pin also functions as the PPG03 output.
59	52	51	P31/SCK1 (UCK1) / LMCO	E	General purpose I/O port.Resource I/O pin (hysteresis input).This pin also functions as the UART/SIO clock input/output pin.
60	53	52	P32/SO1 (UO1)	D	General purpose I/O port.This pin also functions as the UART/SIO clock input/output pin.
61	54	53	P33/SI1 (UI1)	E	General purpose I/O port.Resource input/output pin (hysteresis input).This pin also functions as the UART/SIO serial data input pin.
62	55	54	P34/PTO2	D	General purpose I/O port.This pin also functions as the PWM time 2 output pin.
63	56	55	P35/PWC	E	General purpose I/O port.Resource I/O pin (hysteresis input).This pin also functions as a PWC input.

(Continued)

MB89530 Series

Pin no.			Pin name	I/O circuit type	Function	
SH-DIP*1 MDIP*2	QFP*3 MQFP*4	LQFP*5 BCC*6				
1	58	57	P36/WTO	D	General purpose I/O port.Resource output.This pin also functions as the PWC output pin.	
2	59	58	P37/PTO1	D	General purpose I/O port.Resource output.This pin also functions as the PWM timer 1 output pin.	
3	60	59	P40/INT20/ EC	E	General purpose I/O port.Resource I/O pin (hysteresis input)This pin also functions as an external interrupt input or 16-bit timer/counter input.	
4	61	60	P41/INT21/ SCK2	E	General purpose I/O port.Resource I/O pin (hysteresis input)This pin also functions as an external interrupt input or SIO clock I/O pin.	
5	62	61	P42/INT22/ SO2/SDA	G	N-ch open drain output. Resource I/O pin (hysteresis only for INT22 input) . This pin also functions as an external interrupt input, SIO serial data output, or I ² C data line.	
6	63	62	P43/INT23/ SI2/SCL	G	N-ch open drain output. Resource I/O pin (hysteresis only for INT23 input) . This pin also functions as an external interrupt, SIO serial data input, or I ² C clock I/O pin.	
7	64	63	P44/INT24/ UCK2	E	General purpose I/O port. Resource I/O pin (hysteresis input) . This pin also functions as an external interrupt input or UART clock I/O pin.	
8	1	64	P45/INT25/ UO2	E	General purpose I/O port. Resource I/O pin (hysteresis input) . This pin also functions as an external interrupt input or UART data output pin.	
9	2	1	P46/INT26/ UI2	E	General purpose I/O port. Resource I/O pin (hysteresis input) . This pin also functions as an external interrupt input or UART data input pin.	
10	3	2	P47/INT27/ ADST	E	except for MB89F538L	General purpose I/O port. Resource I/O pin (hysteresis input) . This pin also functions as an external interrupt input or A/D converter clock input pin.
			MOD2	B	MB89F538L	Input pin for memory access mode setting. Connect to V _{SS} directly.
11 to 18	4 to 11	3 to 10	P50/AN0to P57/AN7	H	N-ch open drain output port. This pin also functions as an A/D converter analog input pin.	
22 to 24	15 to 17	14 to 16	P60/INT10 to P62/INT12	I	General purpose input port. Resource input pin (hysteresis input) . This pin also functions as an external interrupt input pin.	

(Continued)

MB89530 Series

(Continued)

Pin no.			Pin name	I/O circuit type	Function	
SH-DIP*1 MDIP*2	QFP*3 MQFP*4	LQFP*5 BCC*6				
25	18	17	P63/INT13	I	Single-clock	General purpose input port. Resource input pin (hysteresis input) . This pin also functions as an external interrupt.
			X0A	A	Dual-clock	Connected pin for sub clock.
26	19	18	P64	J	Single-clock	General purpose input port.
			X1A	A	Dual-clock	Connected pin for sub clock.
64	57	56	V _{CC}	—	Power supply pin.	
32	25	24	V _{SS}	—	Ground pin (GND) .	
19	12	11	AV _{CC}	—	A/D converter power supply pin.	
20	13	12	AVR	—	A/D converter reference voltage input pin.	
21	14	13	AV _{SS}	—	A/D converter power supply pin. Used at the same voltage level as the V _{SS} supply.	
57	50	49	C	—	MB89P538	Fixed at V _{SS} .
					MB89PV530 MB89F538L MB89537/537C MB89538/538C	N.C. pin

*1 : DIP-64P-M01

*2 : MDP-64C-P02

*3 : FPT-64P-M06

*4 : MQP-64C-P01

*5 : FPT-64P-M03/M09

*6 : LCC-64P-M19/M16

MB89530 Series

External EPROM Socket Pin Function Descriptions (MB89PV530 only)

Pin no.		Pin name	I/O Circuit type	Function
MDIP*1	MQFP*2			
65	66	A15	O	Address output pins.
66	67	A12		
67	68	A7		
68	69	A6		
69	70	A5		
70	71	A4		
71	72	A3		
72	73	A2		
73	74	A1		
74	75	A0		
75	77	O1	I	Data input pins.
76	78	O2		
77	79	O3		
78	80	V _{ss}	O	Power supply pin (GND) .
79	82	O4	I	Data input pins.
80	83	O5		
81	84	O6		
82	85	O7		
83	86	O8		
84	87	\overline{CE}	O	ROM chip enable pin. Outputs an "H" level signal in standby mode.
85	88	A10	O	Address output pin.
86	89	\overline{OE}	O	ROM output enable pin. Outputs "L" at all times.
87	91	A11	O	Address output pins.
88	92	A9		
89	93	A8		
90	94	A13	O	
91	95	A14	O	
92	96	V _{cc}	O	EPROM power supply pin.
—	65 76 81 90	N.C.	O	Internally connected. These pins always left open.

*1 : MDP-64C-P02

*2 : MQP-64C-P01

MB89530 Series

I/O CIRCUIT TYPES

Type	Circuit	Remarks
A		Oscillator feedback resistance <ul style="list-style-type: none"> • High speed side = approx. 1 MΩ • Low speed side = approx. 10 MΩ
B		<ul style="list-style-type: none"> • Hysteresis input • Pull-down resistance built-in to MB89537/537C MB89538/538C
C		<ul style="list-style-type: none"> • Pull-up resistance approx. 50 kΩ • Hysteresis input
D		<ul style="list-style-type: none"> • CMOS I/O • Software pull-up resistance can be used. Approx. 50 kΩ
E		<ul style="list-style-type: none"> • CMOS I/O • Software pull-up resistance can be used. Approx. 50 kΩ

(Continued)

(Continued)

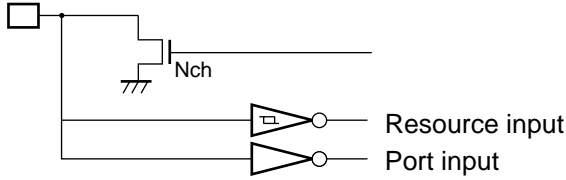
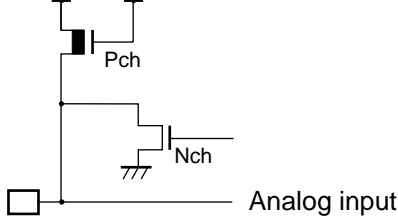
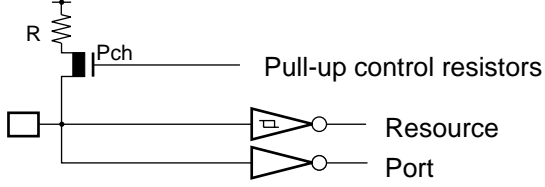
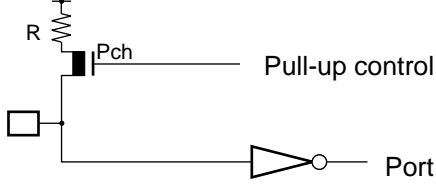
Type	Circuit	Remarks
G		<ul style="list-style-type: none"> • N-ch open drain output • Hysteresis input • CMOS input
H		<ul style="list-style-type: none"> • N-ch open drain output • Analog input (A/D converter)
I		<ul style="list-style-type: none"> • Hysteresis input • CMOS input • Software pull-up resistance can be used. Approx. 50 kΩ
J		<ul style="list-style-type: none"> • CMOS input • Software pull-up resistance can be used. Approx. 50 kΩ

■ HANDLING DEVICES

1. Preventing Latchup

Care must be taken to ensure that maximum voltage ratings are not exceeded (to prevent latchup) . When CMOS integrated circuit devices are subjected to applied voltages higher than V_{CC} at input and output pins (other than medium- and high-withstand voltage pins), or to voltages lower than V_{SS} , as well as when voltages in excess of rated levels are applied between V_{CC} and V_{SS} , the phenomenon known as latchup can occur.

When a latchup condition occurs, supply current can increase dramatically and may destroy semiconductor elements. In using semiconductor devices, always take sufficient care to avoid exceeding maximum ratings.

Also when switching power on or off to analog systems, care must be taken that analog power supplies (AV_{CC} , AVR) and analog input signals do not exceed the level of the digital power supply.

2. Power Supply Voltage Fluctuations

Keep supply voltage levels as stable as possible.

Even within the warranted operating range of the V_{CC} supply voltage, sudden changes in supply voltage can cause abnormal operation. As a measure for stability, it is recommended that the V_{CC} ripple fluctuation (peak to peak value) should be kept within 10% of the reference V_{CC} value on commercial power supply (50 Hz-60 Hz), and instantaneous voltage fluctuations such as at power-on and shutdown should be kept within a transient variability limit of 0.1V/ms.

3. Treatment of Unused Input Pins

If unused input pins are left open, abnormal operation may result. Any unused input pins should be connected to pull-up or pull-down resistance.

4. Treatment of N.C. Pins

Any pins marked 'NC' (not connected) must be left open.

5. Treatment of Power Supply Pins on Models with Built-in A/D Converter

Even when A/D converters are not in use, pins should be connected so that $AV_{CC} = V_{CC}$, and $AV_{SS} = AVR = V_{SS}$.

6. Precautions for Use of External Clock

Even when an external clock signal is used, an oscillator stabilization wait period is used after power-on reset, or escape from sub clock mode or stop mode.

7. Execution of Programs on RAM

Debugging of programs executed on RAM cannot be performed even when using the MB89PV530.

8. Wild Register Functions

Wild registers cannot be debugged with the MB89PV530 and tools. To verify operations, actual in-device testing on the MB89P538 or MB89F538L is advised.

9. Details on Handling C Terminal of MB89530 Series

The MB89530 series contains the following products. The regulator integrated model and the regulator-less model have different performance characteristics.

Part No.	Operation Voltage	integrated model	Terminal type	Terminal treatments
MB89PV530	2.7 V to 5.5 V	Not included	N.C terminal	Not required
MB89P538		Included	C terminal	Fixed to V _{CC}
MB89537/537C	2.2 V to 3.6 V	Not included		N.C terminal
MB89538/538C			Not required	
MB89F538L	2.3 V to 3.6 V			

Although these product models have the same internal resources, the operation sequence after a power-on reset is different between the regulator integrated model and regulator-less model.

The operation sequence after a power-on reset of each model is shown below.

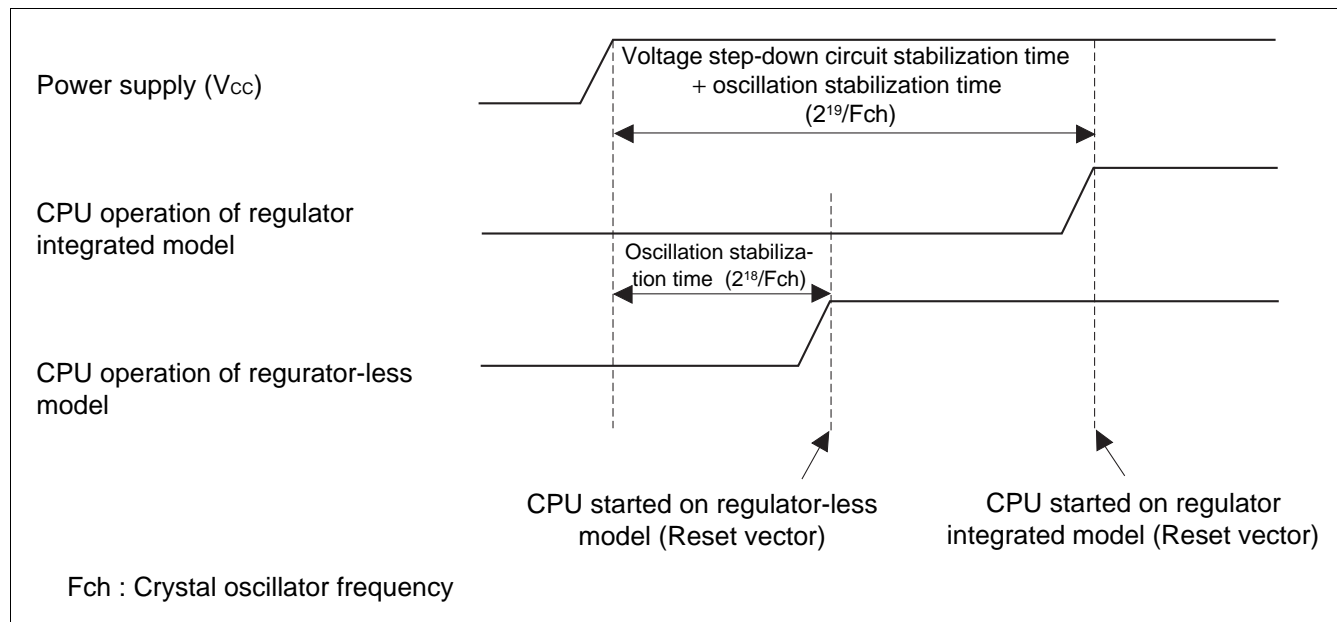

As above, the regulator integrated model starts the CPU behind the regulator-less model. This is because the regulator requires a settling time for normal operation.

The MB89P538 offers a choice of regulator-integrated and regulator-less models selectable depending on the C-terminal treatment. Use the right one for your mask board.

10. Note to Noise In the External Reset Pin (\overline{RST})

If the reset pulse applied to the external reset pin (\overline{RST}) does not meet the specifications, it may cause malfunctions. Use caution so that the reset pulse less than the specifications will not be fed to the external reset pin (\overline{RST}).

MB89530 Series

■ PROGRAMMING AND ERASING FLASH MEMORY ON THE MB89F538L

1. Flash Memory

The flash memory is located between 4000_H and FFFF_H in the CPU memory map and incorporates a flash memory interface circuit that allows read access and program access from the CPU to be performed in the same way as mask ROM. Programming and erasing flash memory is also performed via the flash memory interface circuit by executing instructions in the CPU. This enables the flash memory to be updated in place under the control of the CPU, providing an efficient method of updating program and data.

2. Flash Memory Features

- 48 K byte×8-bit configuration : (16 K+8 K+8 K+16 K sectors)
- Automatic programming algorithm (Embedded algorithm* : Equivalent to MBM29LV200)
- Includes an erase pause and restart function
- Data polling and toggle bit for detection of program/erase completion
- Detection of program/erase completion via CPU interrupt
- Compatible with JEDEC-standard commands
- Sector Erasing (sectors can be combined in any combination)
- No. of program/erase cycles : 10,000 (Min)

* : Embedded Algorithm is a trademark of Advanced Micro Devices.

3. Procedure for Programming and Erasing Flash Memory

Programming and reading flash memory cannot be performed at the same time. Accordingly, to program or erase flash memory, the program must first be copied from flash memory to RAM so that programming can be performed without program access from flash memory.

4. Flash Memory Register

- Control status register (FMCS)

Address	bit7	bit6	bit5	bit4	bit3	bit2	bit1	bit0	Initial value
007A _H	INTE	RDYINT	WE	RDY	Re-served	Re-served	—	Re-served	000X00-0 _B
	R/W	R/W	R/W	R	R/W	R/W	—	R/W	

5. Sector Configuration

The table below shows the sector configuration of flash memory and lists the addresses of each sector for both during CPU access a flash memory programming.

- Sector configuration of flash memory

FLASH Memory	CPU Address	Programmer Address*
16 K bytes	FFFF _H to C000 _H	1FFFF _H to 1C000 _H
8 K bytes	BFFF _H to A000 _H	1BFFF _H to 1A000 _H
8 K bytes	9FFF _H to 8000 _H	19FFF _H to 18000 _H
16 K bytes	7FFF _H to 4000 _H	17FFF _H to 14000 _H

* : The programmer address is the address to be used instead of the CPU address when programming data from a parallel flash memory programmer. Use the programmer address on programming or erasing using a general-purpose parallel programmer.

6. ROM Programmer Adaptor and Recommended ROM Programmers

Part number	Package	Adaptor Part No.	Recommended Programmer Manufacturer and Model
		Sunhayato Corp.	Ando Electric Co., Ltd.
MB89F538L-101PF MB89F538L-201PF	FPT-64P-M06	FLASH-64QF-32DP-8LF	AF9708* AF9709*
MB89F538L-101PFM MB89F538L-201PFM	FPT-64P-M09	FLASH-64QF2-32DP-8LF2	
MB89F538L-101P-SH MB89F538L-201P-SH	DIP-64P-M01	FLASH-64SD-32DP-8LF	
MB89F538L-101PV4 MB89F538L-201PV4	LCC-64P-M19	FLASH-64BCC-32DP-8LF	

* : For the version of the programmer, contact the Flash Support Group, Inc.

- Enquiries
 - Sunhayato Corp. : TEL : +81-3-3984-7791
 - FAX : +81-3-3971-0535
 - E-mail : adapter@sunhayato.co.jp
 - Flash Support Group, Inc. : FAX : +81-53-428-8377
 - E-mail : support@j-fsg.co.jp

MB89530 Series

■ ONE-TIME WRITING SPECIFICATIONS WITH PROM AND EPROM MICROCONTROLLERS

The MB89P538 has a PROM mode with functions equivalent to the MBM27C1001, allowing writing with a general purpose ROM writer using a proprietary adapter. Note, however, that the use of electronic signature mode is not supported.

- ROM writer adapters

With some ROM writers, stability of writing performance is enhanced by placing an 0.1μF capacitor between the Vcc and Vss pins. The following table lists adapters for use with ROM writers.

ROM Writer Adapters

Part number	Package	Compatible adapter
MB89P538-101PF MB89P538-201PF	FPT-64P-M06	ROM-64QF-32DP-8LA2*1
MB89P538-101PFM MB89P538-201PFM	FPT-64P-M09	ROM-64QF2-32DP-8LA
MB89P538-101P-SH MB89P538-201P-SH	DIP-64P-M01	ROM-64SD-32DP-8LA2*1
MB89P538-101P-PV MB89P538-201P-PV	LCC-64P-M16*2	ROM-64BCC-32DP-8LA-FJ

Inquiries should be addressed to

Sunhayato Corp. : TEL : +81-3-3984-7791
 FAX : +81-3-3971-0535
 E-mail : adapter@sunhayato.co.jp

*1 : Version 3 or later should be used.

*2 : Only for ES

- Memory map for EPROM mode

The following illustration shows a memory map for EPROM mode. There are no PROM options.

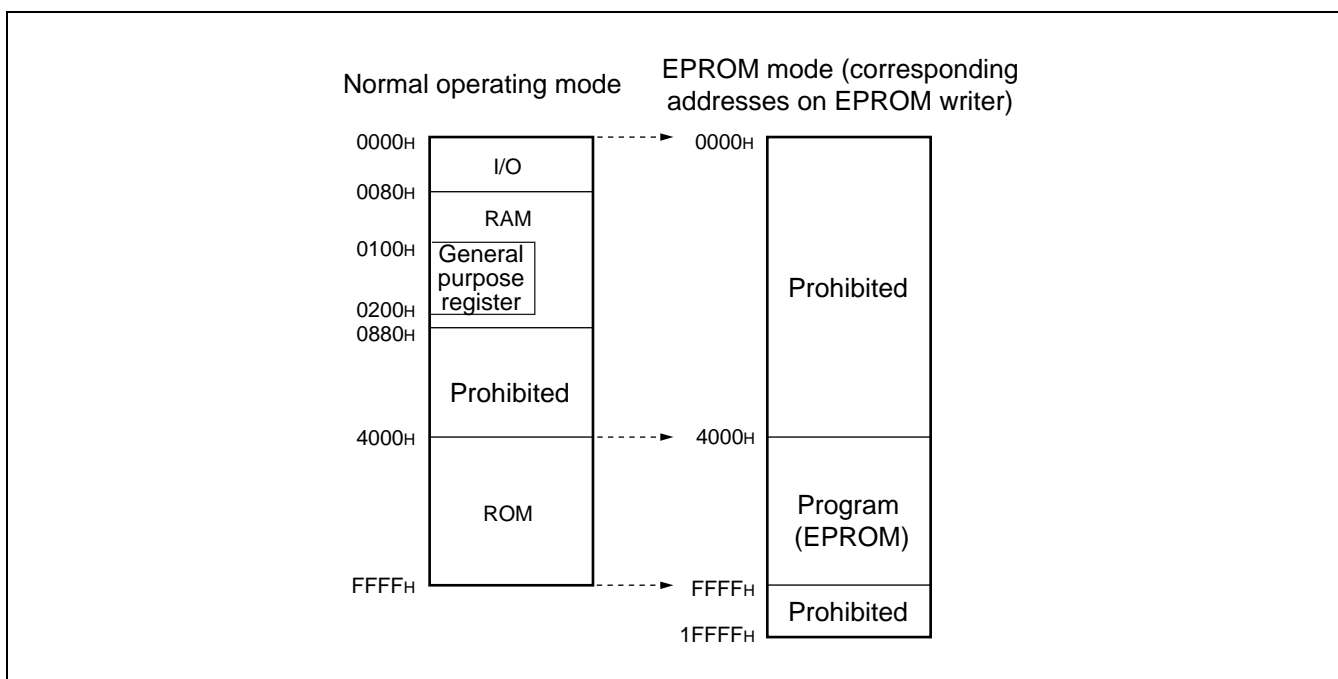

- Recommended screening conditions

Before one-time writing of microcontroller programs to PROM, high temperature aging is recommended as a screening process for chips before they are mounted.

The following diagram shows the flow of the screening process.

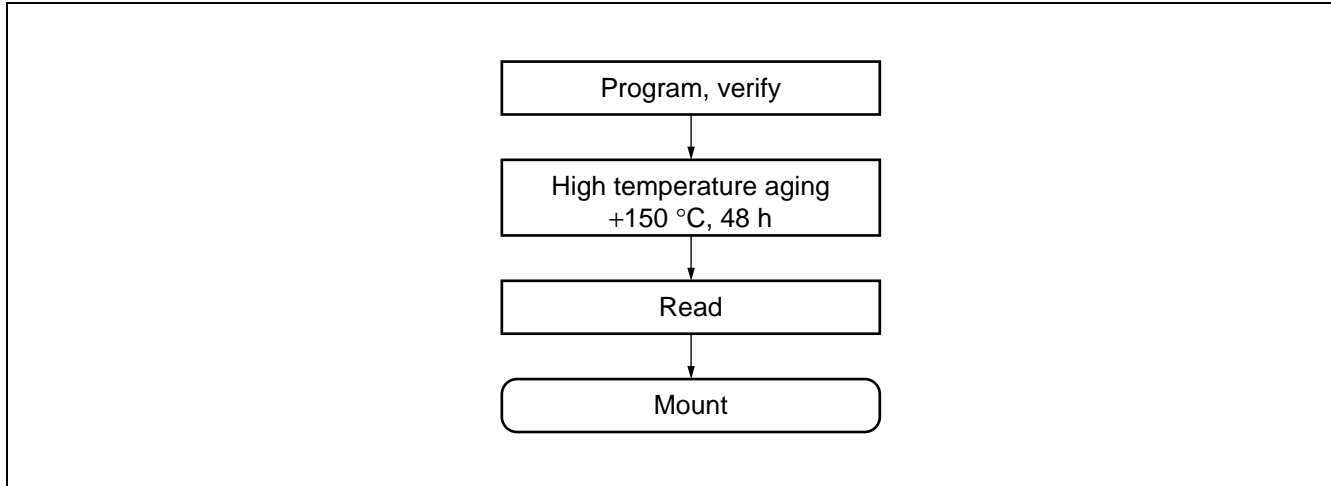

- About writing yields

The nature of chips before one-time writing of microcontroller programs to PROM prevents the use of all-bit writing tests. Therefore it is not possible to guarantee writing yields of 100% in some cases.

MB89530 Series

■ EPROM WRITING TO PIGGY-BACK/EVALUATION CHIPS

This section describes methods of writing to EPROM on piggy-back/evaluation chips.

- EPROM model
MBM27C512-20TV

- Writer adapter

For writing to EPROM using a ROM writer, use one of the writer adapters shown below (manufactured by Sunhayato Corp.) .

Package	Adapter socket model
LCC-32 (rectangular)	ROM-32LC-28DP-YG

Inquiries should be addressed to

Sunhayato Corp. : TEL : +81-3-3984-7791
FAX : +81-3-3971-0535
E-mail : adapter@sunhayato.co.jp

- Memory Space

Piggy-back/Evaluation Memory Map

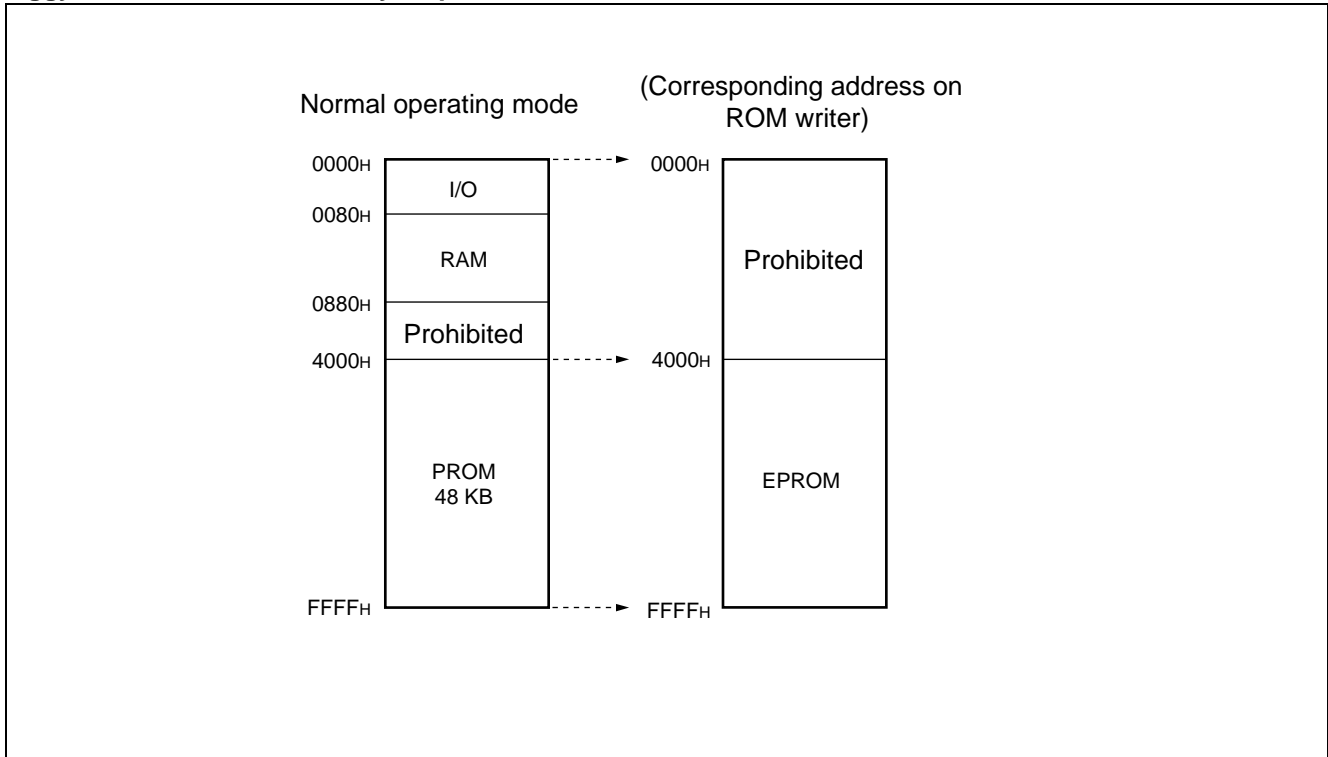

- Writing to EPROM

- 1) Set up the EPROM writer for the MBM27C512.
- 2) Load program data to the ERPOM writer, in the area 4000H - FFFFH.
- 3) Use the EPROM writer to write to the area 4000H - FFFFH.

■ BLOCK DIAGRAM

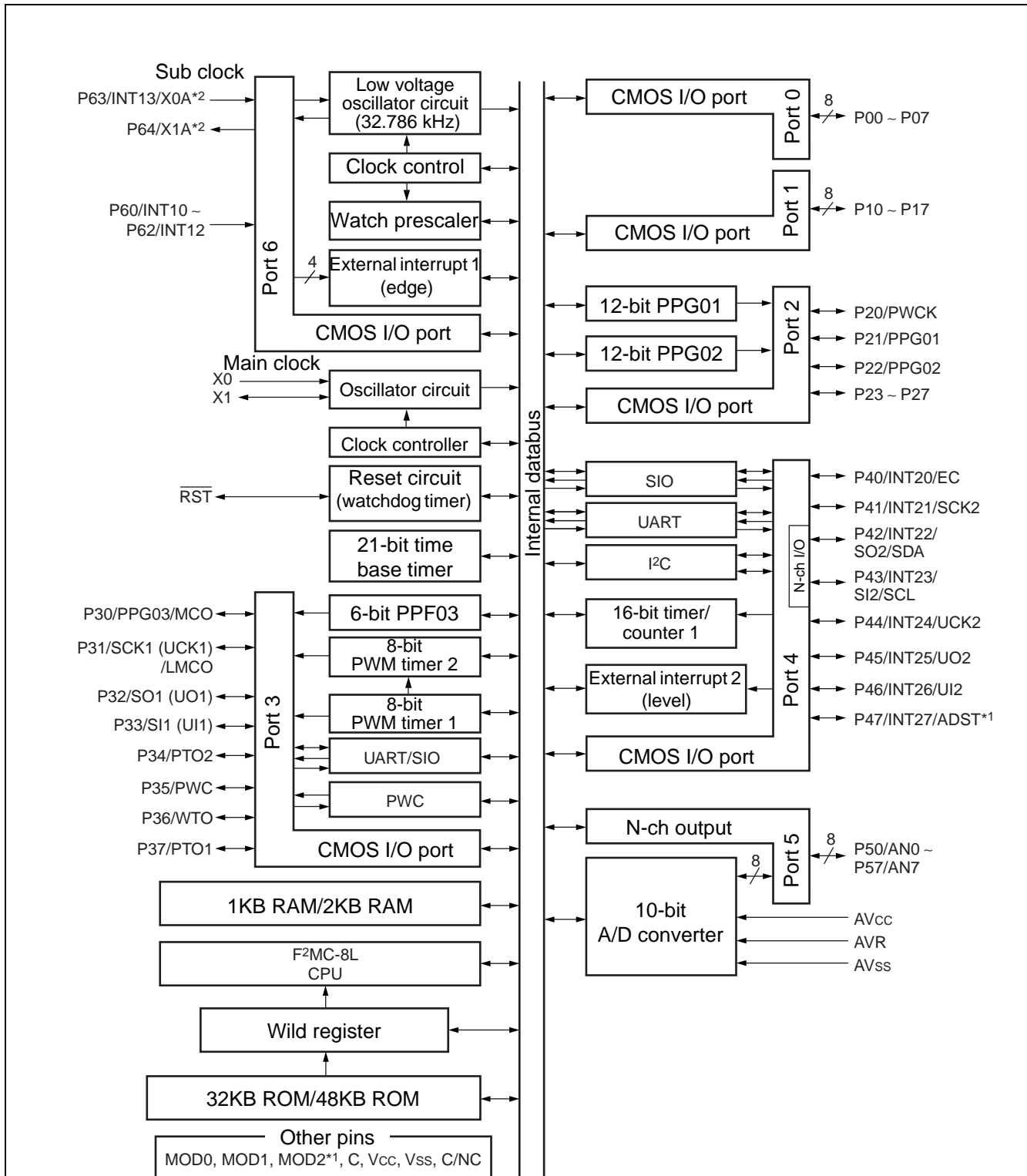

*1 : P47/INT27/ADST pins except for MB89F538L, MOD2 pin for MB89F538L

*2 : P63/INT13, P64 pins for single-clock, X0A, X1A pins for dual-clock

MB89530 Series

■ CPU CORE

1. Memory Space

The MB89530 series has 64 KB of memory space, containing all I/O, data areas, and program areas. The I/O area is located at the lowest addresses, with the data area placed immediately above. The data area can be partitioned into register areas, stack areas, or direct access areas depending on the application. The program area is located at the opposite end of memory, closest to the highest addresses, and the highest part of this area is assigned to the tables of interrupt and reset vectors and vector call instructions. The following diagram shows the structure of memory space in the MB89530 series.

• Memory Map

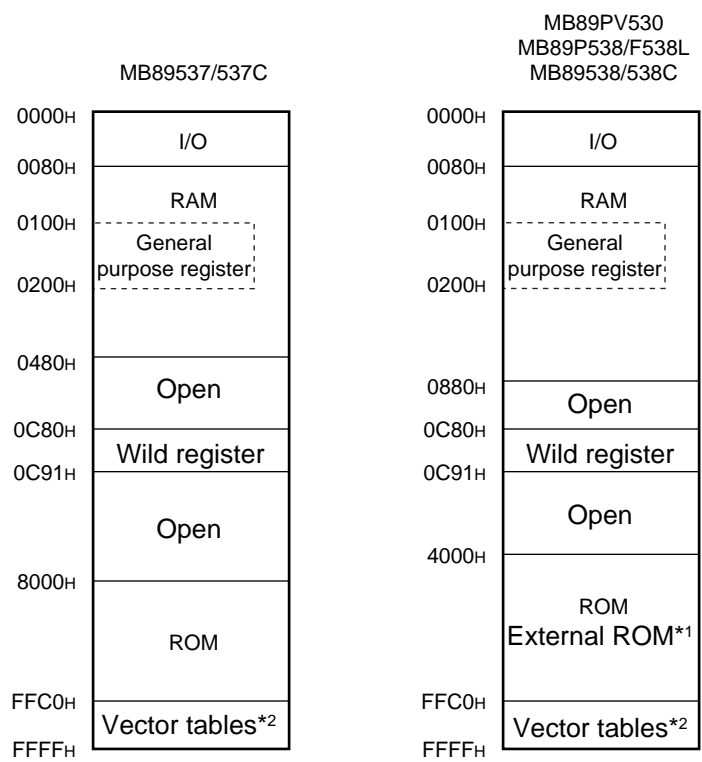

*1 : The external ROM area is on the MB89PV530 only.

*2 : Vector tables (reset, interrupt, vector call instructions)

2. Registers

The F²MC-8L series has two types of registers, dedicated-use registers within the CPU, and general-purpose registers in memory.

The dedicated-use registers are the following.

- Program counter (PC) : 16-bit length, shows the location where instructions are stored.
- Accumulator (A) : 16-bit length, a temporary memory register for calculation operations.
The lower byte is used for 8-bit data processing instructions.
- Temporary accumulator (T) : 16-bit length, performs calculations with the accumulator.
The lower byte is used for 8-bit data processing instructions.
- Index register (IX) : 16-bit length, a register for index modification.
- Extra pointer (EP) : 16-bit length, a pointer indicating memory addresses.
- Stack pointer (SP) : 16-bit length, indicates stack areas.
- Program status (PS) : 16-bit length, contains register pointer and condition code.

← 16 bits →		Initial value
PC	: Program counter	FFFD _H
A	: Accumulator	Not fixed
T	: Temporary accumulator	Not fixed
IX	: Index register	Not fixed
EP	: Extra pointer	Not fixed
SP	: Stack pointer	Not fixed
PS	: Program status	I-flag = 0, IL1, 0 = 11 Other bits not fixed

In addition, the PS register can be divided so that the upper 8 bits are used as a register bank pointer (RP), and the lower 8 bits as a condition code register (CCR). (See the following illustration.)

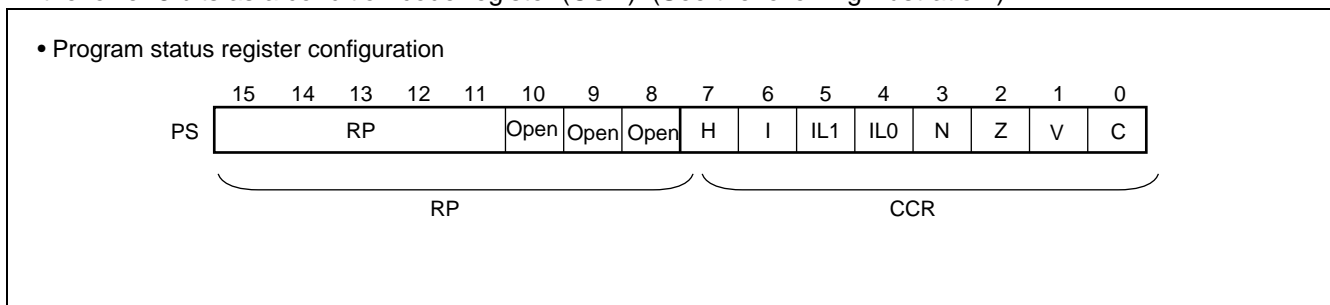

MB89530 Series

The RP register shows the address of the register bank currently being used, so that the RP value and the actual address are related by the conversion rule shown in the following illustration.

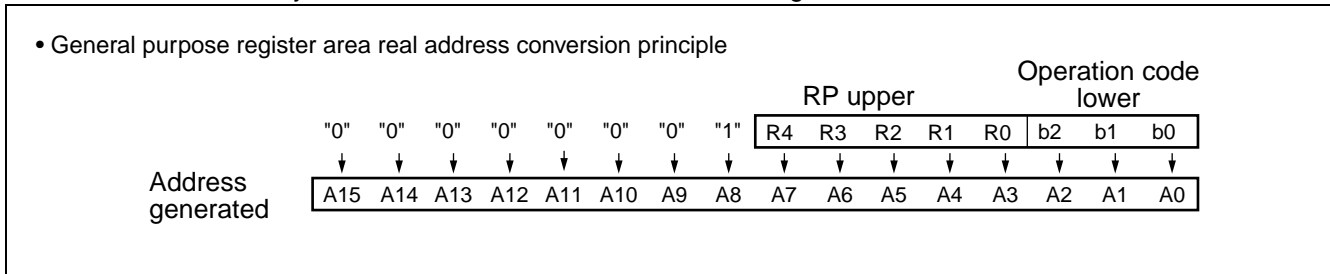

The CCR register has bits that show the content of results of calculations and transferred data, and bits that control CPU operation during interrupts.

- H-flag : Set to 1 if calculations result in carry or borrow operations from bit 3 to bit 4, otherwise set to 0.
This flag is used for decimal correction instructions.
- I-flag : This flag is set to 1 if interrupts are enabled, and 0 if interrupts are prohibited.
The default value at reset is 0.
- IL1, 0 : Indicates the level of the currently permitted interrupts.
Only interrupt requests having a more powerful level than the value of these bits will be processed.

IL1	IL0	Interrupt level	Strength
0	0	1	Strong ↑ ↓ Weak
0	1		
1	0	2	
1	1	3	

- N-flag : Set to 1 if the highest bit is 1 after a calculation, otherwise cleared to 0.
- Z-flag : Set to 1 if a calculation result is 0, otherwise cleared to 0.
- V-flag : Set to 1 if a two's complement overflow results during a calculation, otherwise cleared to 0.
- C-flag : Set to 1 if a calculation results in a carry or borrow operation from bit 7, otherwise cleared to 0.
This is also the shift-out value in a shift instruction.

In addition, the following general purpose registers are available.

General purpose registers: 8-bit length, used to contain data.

The general purpose registers are 8-bit registers located in memory. There are eight such registers per bank, and the MB89530 series have up to 32 banks for use. The bank currently in use is indicated by the register bank pointer (RP).

- Register bank configuration

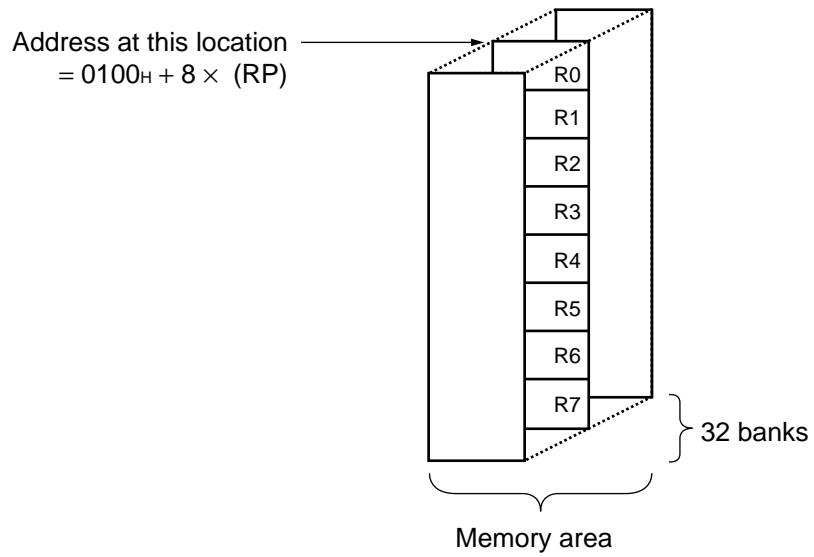

MB89530 Series

■ I/O MAP

Address	Register name	Register description	Write/Read	Initial value
00H	PDR0	Port 0 data register	R/W	XXXXXXXX _B
01H	DDR0	Port 0 direction register	W	00000000 _B
02H	PDR1	Port 1 data register	R/W	XXXXXXXX _B
03H	DDR1	Port 1 direction register	W	00000000 _B
04H to 06H	(Reserved area)			
07H	SYCC	System clock control register	R/W	X-1MM100 _B
08H	STBC	Standby control register	R/W	00010-- _B
09H	WDTC	Watchdog control register	R/W	0---XXXX _B
0AH	TBTC	Time base timer control register	R/W	00---000 _B
0BH	WPCR	Watch prescaler control register	R/W	00--0000 _B
0CH	PDR2	Port 2 data register	R/W	XXXXXXXX _B
0DH	DDR2	Port 2 direction register	R/W	00000000 _B
0EH	PDR3	Port 3 data register	R/W	XXXXXXXX _B
0FH	DDR3	Port 3 direction register	R/W	00000000 _B
10H	PDR4	Port 4 data register	R/W	XXXX11XX _B
11H	DDR4	Port 4 direction register	R/W	0000--00 _B
12H	PDR5	Port 5 data register	R/W	11111111 _B
13H	PDR6	Port 6 data register	R	XXXXXXXX _B
14H to 21H	(Reserved area)			
22H	SMC11	Serial mode control register 1 (UART)	R/W	00000000 _B
23H	SRC1	Serial route control register (UART)	R/W	--011000 _B
24H	SSD1	Serial status and data register (UART)	R/W	00100-1X _B
25H	SIDR1/ SODR1	Serial input/output data register (UART)	R/W	XXXXXXXX _B
26H	SMC12	Serial mode control register 2 (UART)	R/W	--100001 _B
27H	CNTR1	PWM control register 1	R/W	00000000 _B
28H	CNTR2	PWM control register 2	R/W	000-0000 _B
29H	CNTR3	PWM control register 3	R/W	-000--- _B
2AH	COMR1	PWM compare register 1	W	XXXXXXXX _B
2BH	COMR2	PWM compare register 2	W	XXXXXXXX _B
2CH	PCR1	PWC pulse width control register 1	R/W	000--000 _B
2DH	PCR2	PWC pulse width control register 2	R/W	00000000 _B
2EH	RLBR	PWC reload buffer register	R/W	XXXXXXXX _B
2FH	SMC21	Serial mode control register 1 (UART/SIO)	R/W	00000000 _B
30H	SMC22	Serial mode control register 2 (UART/SIO)	R/W	00000000 _B
31H	SSD2	Serial status and data register (UART/SIO)	R/W	00001--- _B
32H	SIDR2/ SODR2	Serial data register (UART/SIO)	R/W	XXXXXXXX _B

(Continued)

MB89530 Series

Address	Register name	Register description	Write/Read	Initial value
33 _H	SRC2	Baud rate generator reload register	R/W	XXXXXXXX _B
34 _H	ADC1	A/D control register 1	R/W	000000-0 _B
35 _H	ADC2	A/D control register 2	R/W	-0000001 _B
36 _H	ADDL	A/D data register low	R/W	XXXXXXXX _B
37 _H	ADDH	A/D data register high	R/W	-----00 _B
38 _H	PPGC2	PPG2 control register (12-bit PPG)	R/W	00000000 _B
39 _H	PRL22	PPG2 reload register 2 (12-bit PPG)	R/W	0X000000 _B
3A _H	PRL21	PPG2 reload register 1 (12-bit PPG)	R/W	XX000000 _B
3B _H	PRL23	PPG2 reload register 3 (12-bit PPG)	R/W	XX000000 _B
3C _H	TMCR	16-bit timer control register	R/W	--000000 _B
3D _H	TCHR	16-bit timer counter register high	R/W	00000000 _B
3E _H	TCLR	16-bit timer counter register low	R/W	00000000 _B
3F _H	EIC1	External interrupt 1 control register 1	R/W	00000000 _B
40 _H	EIC2	External interrupt 1 control register 2	R/W	00000000 _B
41 _H to 48 _H	(Reserved area)			
49 _H	DDCR	DDC select register	R/W	-----0 _B
4A _H to 4B _H	(Reserved area)			
4C _H	PPGC1	PPG1 control register (12-bit PPG)	R/W	00000000 _B
4D _H	PRL12	PPG1 reload register 2 (12-bit PPG)	R/W	0X000000 _B
4E _H	PRL11	PPG1 reload register 1 (12-bit PPG)	R/W	XX000000 _B
4F _H	PRL13	PPG1 reload register 3 (12-bit PPG)	R/W	XX000000 _B
50 _H	IACR	I ² C address control register	R/W	-----000 _B
51 _H	IBSR	I ² C bus status register	R	00000000 _B
52 _H	IBCR	I ² C bus control register	R/W	00000000 _B
53 _H	ICCR	I ² C clock control register	R/W	000XXXXX _B
54 _H	IADR	I ² C address register	R/W	-XXXXXXXX _B
55 _H	IDAR	I ² C data register	R/W	XXXXXXXX _B
56 _H	EIE2	External interrupt 2 control register	R/W	00000000 _B
57 _H	EIF2	External interrupt 2 flag register	R/W	-----0 _B
58 _H	RCR1	6-bit PPG control register 1	R/W	00000000 _B
59 _H	RCR2	6-bit PPG control register 2	R/W	0X000000 _B
5A _H	CKR	Clock output control register	R/W	-----00 _B
5B _H to 6F _H	(Reserved area)			
70 _H	SMR	Serial mode register (SIO)	R/W	00000000 _B
71 _H	SDR	Serial data register (SIO)	R/W	XXXXXXXX _B
72 _H	PURR0	Port 0 pull-up resistance register	R/W	11111111 _B
73 _H	PURR1	Port 1 pull-up resistance register	R/W	11111111 _B
74 _H	PURR2	Port 2 pull-up resistance register	R/W	11111111 _B
75 _H	PURR3	Port 3 pull-up resistance register	R/W	11111111 _B

(Continued)

MB89530 Series

(Continued)

Address	Register name	Register description	Write/Read	Initial value
76 _H	PURR4	Port 4 pull-up resistance register	R/W	1111--11 _B
77 _H	WREN	Wild register enable register	R/W	--000000 _B
78 _H	WROR	Wild register data test register	R/W	--000000 _B
79 _H	PURR6	Port 6 pull-up resistance register	R/W	---11111 _B
7A _H	FMCS	FLASH control status register	R/W	000X00 - 0 _B
7B _H	ILR1	Interrupt level setting register 1	W	11111111 _B
7C _H	ILR2	Interrupt level setting register 2	W	11111111 _B
7D _H	ILR3	Interrupt level setting register 3	W	11111111 _B
7E _H	ILR4	Interrupt level setting register 4	W	11111111 _B
7F _H	ITR	Interrupt test register	Access prohibited	XXXXXX00 _B
C80 _H	WRARH1	Upper address setting register 1	R/W	XXXXXXXX
C81 _H	WRARL1	Lower address setting register 1	R/W	XXXXXXXX
C82 _H	WRDR1	Data setting register 1	R/W	XXXXXXXX
C83 _H	WRARH2	Upper address setting register 2	R/W	XXXXXXXX
C84 _H	WRARL2	Lower address setting register 2	R/W	XXXXXXXX
C85 _H	WRDR2	Data setting register 2	R/W	XXXXXXXX
C86 _H	WRARH3	Upper address setting register 3	R/W	XXXXXXXX
C87 _H	WRARL3	Lower address setting register 3	R/W	XXXXXXXX
C88 _H	WRDR3	Data setting register 3	R/W	XXXXXXXX
C89 _H	WRARH4	Upper address setting register 4	R/W	XXXXXXXX
C8A _H	WRARL4	Lower address setting register 4	R/W	XXXXXXXX
C8B _H	WRDR4	Data setting register 4	R/W	XXXXXXXX
C8C _H	WRARH5	Upper address setting register 5	R/W	XXXXXXXX
C8D _H	WRARL5	Lower address setting register 5	R/W	XXXXXXXX
C8E _H	WRDR5	Data setting register 5	R/W	XXXXXXXX
C8F _H	WRARH6	Upper address setting register 6	R/W	XXXXXXXX
C90 _H	WRARL6	Lower address setting register 6	R/W	XXXXXXXX
C91 _H	WRDR6	Data setting register 6	R/W	XXXXXXXX

• Description of write/read symbols :

R/W : read/write enabled

R : Read only

W : Write only

• Description of initial values :

0 : This bit initialized to "0".

1 : This bit initialized to "1".

X : The initial value of this bit is not determined.

M : The initial value of this bit is a mask option.

- : This bit is not used.

Note : Do not use reserved spaces.

■ ELECTRICAL CHARACTERISTICS

1. Absolute Maximum Ratings

(AVSS = VSS = 0 V)

Parameter	Symbol	Rating		Unit	Remarks
		Min	Max		
Supply voltage	V _{CC} AV _{CC}	V _{SS} - 0.3	V _{SS} + 4.0	V	MB89537/538 MB89537C/538C *1
	AVR	V _{SS} - 0.3	V _{SS} + 4.0	V	MB89F538L
	V _{CC} AV _{CC}	V _{SS} - 0.3	V _{SS} + 6.0	V	MB89P538 MB89PV530 *1
	AVR	V _{SS} - 0.3	V _{SS} + 6.0	V	
Input voltage	V _I	V _{SS} - 0.3	V _{CC} + 0.3	V	Other than P42, P43
		V _{SS} - 0.3	V _{SS} + 6.0	V	Only P42, P43
Output voltage	V _O	V _{SS} - 0.3	V _{CC} + 0.3	V	Other than P42, P43
		V _{SS} - 0.3	V _{SS} + 6.0	V	Only P42, P43
Maximum clamp current	I _{CLAMP}	- 2.0	+ 2.0	mA	*2
Total maximum clamp current	∑ I _{CLAMP}	—	20	mA	*2
"L" level maximum output current	I _{OL}	—	15	mA	
"L" level average output current	I _{OLAV}	—	4	mA	Average value (operating current × operating duty)
"L" level maximum total output current	∑I _{OL}	—	100	mA	
"L" level average total output current	∑I _{OLAV}	—	40	mA	Average value (operating current × operating duty)
"H" level maximum output current	I _{OH}	—	-15	mA	
"H" level average output current	I _{OHAV}	—	-4	mA	Average value (operating current × operating duty)
"H" level maximum total output current	∑I _{OH}	—	-50	mA	
"H" level average total output current	∑I _{OHAV}	—	-20	mA	Average value (operating current × operating duty)
Current consumption	P _D	—	300	mW	
Operating temperature	T _A	-40	+85	°C	
Storage temperature	T _{stg}	-55	+150	°C	

*1 : AV_{CC} and V_{CC} are to be used at the same potential. AVR should not exceed AV_{CC} + 0.3 V.

*2 : • Applicable to pins : P00 to P07, P10 to P17, P20 to P27, P30 to P37, P40, P41, P44 to P47, P50 to P57, P60 to P64

- Use within recommended operating conditions.
- Use at DC voltage (current) .

(Continued)

MB89530 Series

(Continued)

- The +B signal should always be applied with a limiting resistance placed between the +B signal and the microcontroller.
- The value of the limiting resistance should be set so that when the +B signal is applied the input current to the microcontroller pin does not exceed rated values, either instantaneously or for prolonged periods.
- Note that when the microcontroller drive current is low, such as in the power saving modes, the +B input potential may pass through the protective diode and increase the potential at the V_{CC} pin, and this may affect other devices.
- Note that if a +B signal is input when the microcontroller current is off (not fixed at 0 V), the power supply is provided from the pins, so that incomplete operation may result.
- Note that if the +B input is applied during power-on, the power supply is provided from the pins and the resulting supply voltage may not be sufficient to operate the power-on result.
- Care must be taken not to leave the +B input pin open.
- Note that analog system input/output pins other than the A/D input pins (LCD drive pins, comparator input pins, etc.) cannot accept +B signal input.
- Sample recommended circuits :

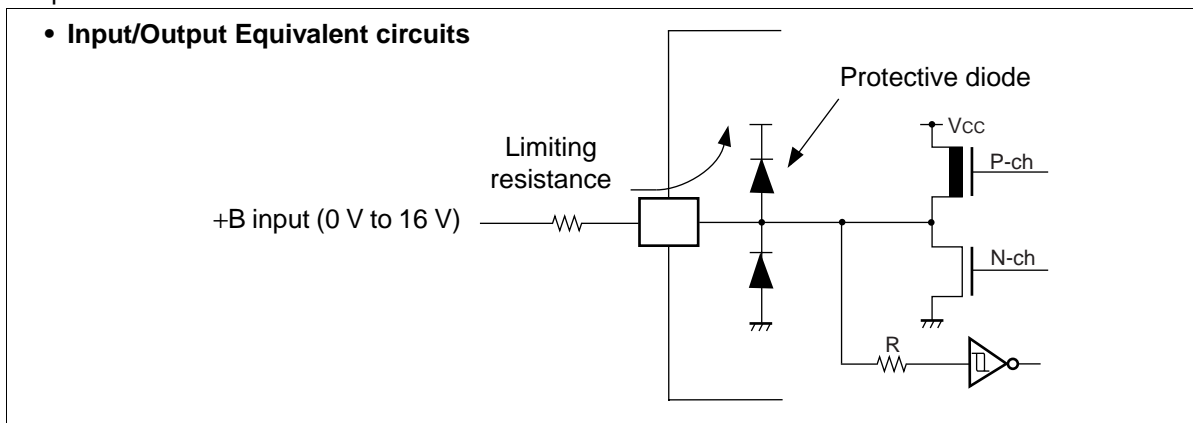

WARNING: Semiconductor devices can be permanently damaged by application of stress (voltage, current, temperature, etc.) in excess of absolute maximum ratings. Do not exceed these ratings.

2. Recommended Operating Conditions

(AVss = Vss = 0 V)

Parameter	Symbol	Value		Unit	Remarks	
		Min	Max			
Supply voltage	V _{CC} , AV _{CC}	2.2*	3.6	V	Range warranted for normal operation	MB89537/538 MB89537C/ 538C
		1.5	3.6	V	RAM status in stop mode	
		2.4	3.6	V	Range warranted for normal operation	MB89F538L
		1.5	3.6	V	RAM status in stop mode	
		2.7*	5.5	V	Range warranted for normal operation	MB89P538 MB89PV530
	1.5	5.5	V	RAM status in stop mode		
	AVR	2.4	AV _{CC}	V		
Operating temperature	T _A	-40	+85	°C		

* : Varies according to frequency used, and instruction cycle.

See "Operating voltage vs. operating frequency (MB89537/MB89538/MB89537C/MB89538C) and (MB89P538/MB89PV530)" and "5. A/D Converter Electrical Characteristics".

Operating voltage vs. operating frequency (MB89537/MB89538/MB89537C/MB89538C)

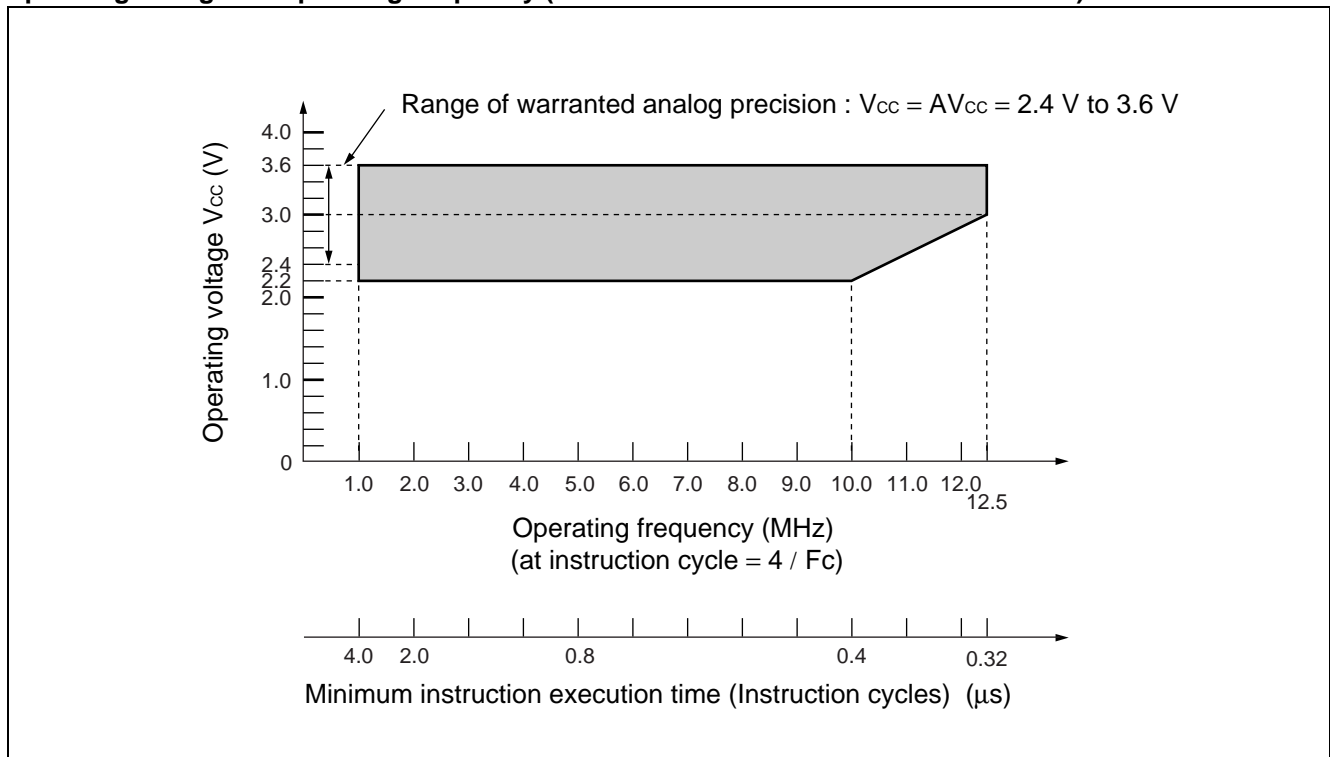

MB89530 Series

Operating voltage vs. operating frequency (MB89F538L)

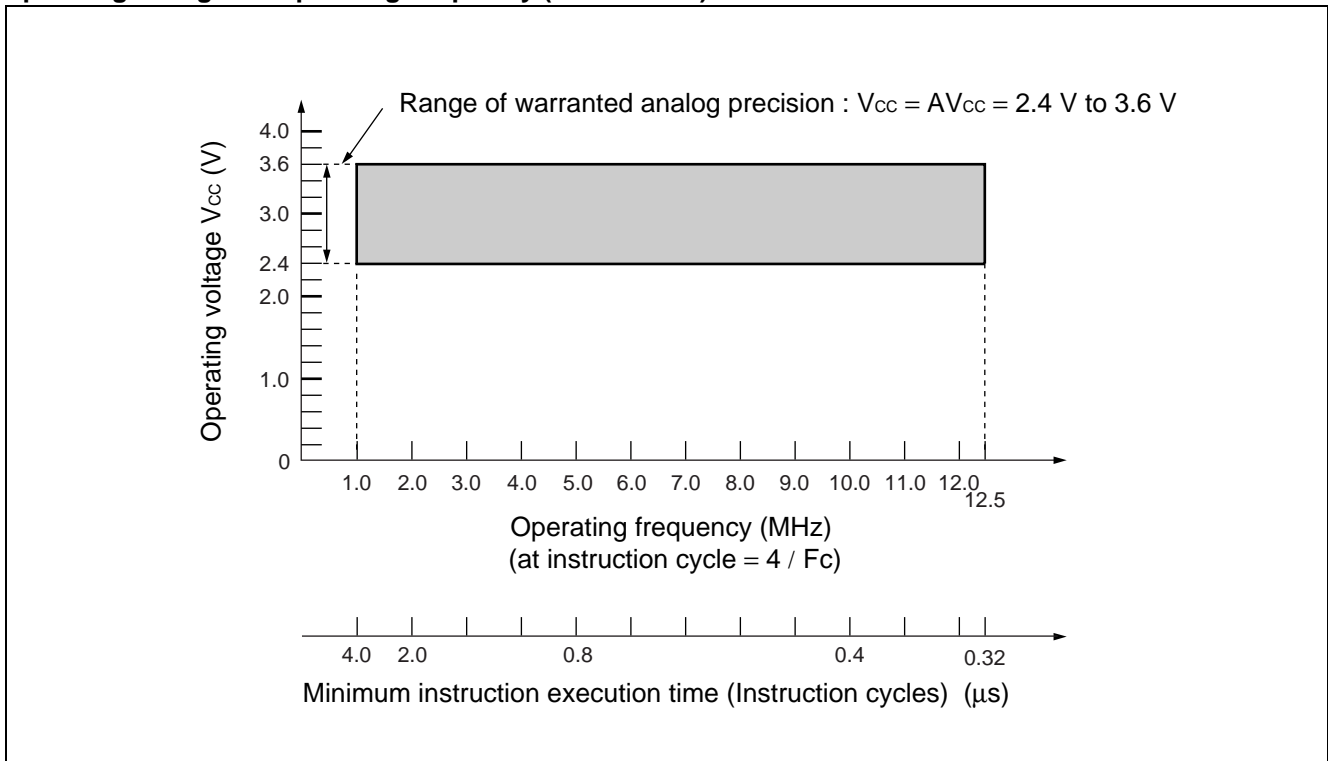

Operating voltage vs. operating frequency (MB89P538/MB89PV530)

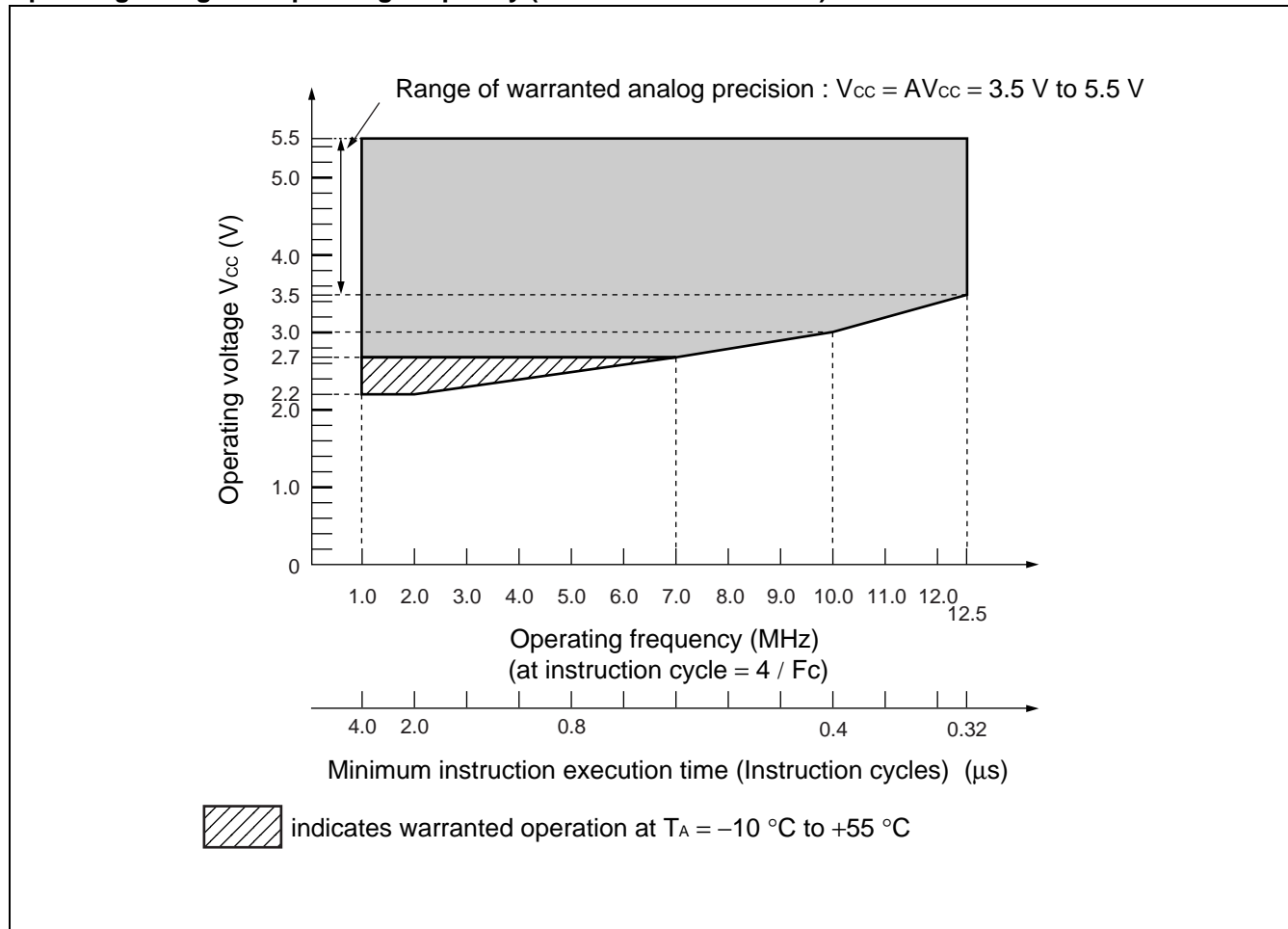

WARNING: The recommended operating conditions are required in order to ensure the normal operation of the semiconductor device. All of the device's electrical characteristics are warranted when the device is operated within these ranges.

Always use semiconductor devices within their recommended operating condition ranges. Operation outside these ranges may adversely affect reliability and could result in device failure.

No warranty is made with respect to uses, operating conditions, or combinations not represented on the data sheet. Users considering application outside the listed conditions are advised to contact their FUJITSU representatives beforehand.

MB89530 Series

3. DC Characteristics

($V_{CC} = V_{CC} = 3.0\text{ V}$, $V_{SS} = V_{SS} = 0\text{ V}$, $T_A = -40\text{ }^\circ\text{C}$ to $+85\text{ }^\circ\text{C}$)

Parameter	Symbol	Pin name	Condition	Value			Unit	Remarks
				Min	Typ	Max		
"H" level input voltage	V_{IH}	P00 to P07, P10 to P17, P20 to P27, P30 to P37, P40 to P47, P60 to P64, SI1, SI2	—	$0.7 V_{CC}$	—	$V_{CC} + 0.3$	V	
	V_{IHS}	RST, MOD0, MOD1, INT20 to INT27, UCK1, UI1, INT10 to INT13, SCK1, EC, PWCK, PWC, SCK2, UCK2, UI2, ADST	—	$0.8 V_{CC}$	—	$V_{CC} + 0.3$	V	
	V_{IHSMB}	SCL, SDA	—	$V_{SS} + 1.4$	—	$V_{SS} + 5.5$	V	With SMB input buffer selected*
	V_{IH2C}		—	$0.7 V_{CC}$	—	$V_{SS} + 5.5$	V	With I ² C input buffer selected*
"L" level input voltage	V_{IL}	P00 to P07, P10 to P17, P20 to P27, P30 to P37, P40 to P47, P60 to P64, SI1, SI2	—	$V_{SS} - 0.3$	—	$0.3 V_{CC}$	V	
	V_{ILS}	RST, MOD0, MOD1, INT20 to INT27, UCK1, UI1, INT10 to INT13, SCK1, EC, PWCK, PWC, SCK2, UCK2, UI2, ADST	—	$V_{SS} - 0.3$	—	$0.2 V_{CC}$	V	
	V_{ILSMB}	SCL, SDA	—	$V_{SS} - 0.3$	—	$V_{SS} + 0.6$	V	With SMB input buffer selected*
	V_{IL2C}		—	$V_{SS} - 0.3$	—	$0.3 V_{CC}$	V	With I ² C input buffer selected*
Open drain output applied voltage	V_{D1}	P50 to P57	—	$V_{SS} - 0.3$	—	$V_{CC} + 0.3$	V	
	V_{D2}	P42, P43				$V_{SS} + 5.5$	V	
"H" level output voltage	V_{OH}	P00 to P07, P10 to P17, P20 to P24, P30 to P37, P40, P41, P44 to P47	$I_{OH} = -2.0\text{ mA}$	2.4	—	—	V	
		P25 to P27	$I_{OH} = -3.0\text{ mA}$					
"L" level output voltage	V_{OL}	P00 to P07, P10 to P17, P20 to P27, P30 to P37, P40 to P47, P50 to P57, RST	$I_{OL} = 4.0\text{ mA}$	—	—	0.4	V	
Input leak current (Hi-Z output leak current)	I_{LI}	P00 to P07, P10 to P17, P20 to P27, P30 to P37, P40 to P47, P50 to P57, P60 to P64	$0.0\text{ V} < V_I < V_{CC}$	-5	—	+5	μA	With no pull-up resistance specified

(Continued)

MB89530 Series

(Continued)

($AV_{CC} = V_{CC} = 3.0\text{ V}$, $AV_{SS} = V_{SS} = 0\text{ V}$, $T_A = -40\text{ }^\circ\text{C}$ to $+85\text{ }^\circ\text{C}$)

Parameter	Symbol	Pin name	Condition	Value			Unit	Remarks
				Min	Typ	Max		
Open drain output leak current	I_{LIOD}	P42, P43	$0.0\text{ V} < V_I < V_{SS} + 5.5\text{ V}$	—	—	+5	μA	
Pull-up resistance	R_{PULL}	P00 to P07, P10 to P17, P20 to P27, P30 to P37, P40, P41, P44 to P47, P60 to P64, $\overline{\text{RST}}$	$V_I = 0.0\text{ V}$	25	50	100	$\text{k}\Omega$	With pull-up resistance is selected. The $\overline{\text{RST}}$ signal is excluded.
Supply current	I_{CC1}	V_{CC}	$F_{CH} = 10.0\text{ MHz}$ $t_{inst} = 0.4\text{ }\mu\text{s}$	—	6	10	mA	Normal operation
			$F_{CH} = 10.0\text{ MHz}$ $t_{inst} = 0.4\text{ }\mu\text{s}$	—	—	45	mA	FLASH memory programming/erase MB89F538L
	I_{CC2}		$F_{CH} = 10.0\text{ MHz}$ $t_{inst} = 6.4\text{ }\mu\text{s}$	—	1.5	3	mA	
	I_{CCS1}		$F_{CH} = 10.0\text{ MHz}$ $t_{inst} = 0.4\text{ }\mu\text{s}$	—	2	4	mA	Sleep mode
	I_{CCS2}		$F_{CH} = 10.0\text{ MHz}$ $t_{inst} = 6.4\text{ }\mu\text{s}$	—	1	2	mA	Sleep mode
	I_{CCL}		$F_{CL} = 32.768\text{ kHz}$	—	1	3	mA	Sub mode MB89P538/PV530
			$F_{CL} = 32.768\text{ kHz}$ $T_A = +25\text{ }^\circ\text{C}$	—	35	90	μA	Sub mode MB89F538L
	I_{CCLS}		$F_{CL} = 32.768\text{ kHz}$	—	20	50	μA	Sub mode MB89537/538 MB89537C/538C
			$F_{CL} = 32.768\text{ kHz}$	—	15	30	μA	Sub, sleep modes Except MB89F538L
			$F_{CL} = 32.768\text{ kHz}$ $T_A = +25\text{ }^\circ\text{C}$	—	15	30	μA	Watch mode, main stop MB89F538L
	I_{CCT}		$F_{CL} = 32.768\text{ kHz}$	—	5	15	μA	Watch mode, main stop Except MB89F538L
			$F_{CL} = 32.768\text{ kHz}$ $T_A = +25\text{ }^\circ\text{C}$	—	5	15	μA	Sub, sleep modes MB89F538L
	I_{CCH}		$T_A = +25\text{ }^\circ\text{C}$	—	1	5	μA	Sub, stop modes
	I_A		AV_{CC}	$F_{CH} = 10.0\text{ MHz}$	—	1	3	mA
$T_A = +25\text{ }^\circ\text{C}$		—		1	5	μA	A/D stopped	
Input capacitance	C_{IN}	Except V_{CC} , V_{SS} , AV_{CC} , AV_{SS}	$f = 1\text{ MHz}$	—	5	15	pF	

* : The MB89PV530/P538/F538L/537C/538C have a built-in I²C function, and a choice of input buffers by software setting. The MB89537/538 have no built-in I²C functions, and therefore this standard does not apply.

MB89530 Series

4. AC Characteristics

(1) Reset Timing

($V_{CC} = 3.0\text{ V}$, $A_{VSS} = V_{SS} = 0\text{ V}$, $T_A = -40\text{ }^\circ\text{C}$ to $+85\text{ }^\circ\text{C}$)

Parameter	Symbol	Condition	Value		Unit	Remarks
			Min	Max		
$\overline{\text{RST}}$ "L" pulse width	t_{ZLZH}	—	$48 t_{\text{HCYL}}$	—	ns	

Notes : • t_{HCYL} is the main clock oscillator period.

- If the reset pulse applied to the external reset pin ($\overline{\text{RST}}$) does not meet the specifications, it may cause malfunctions. Use caution so that the reset pulse less than the specifications will not be fed to the external reset pin ($\overline{\text{RST}}$).

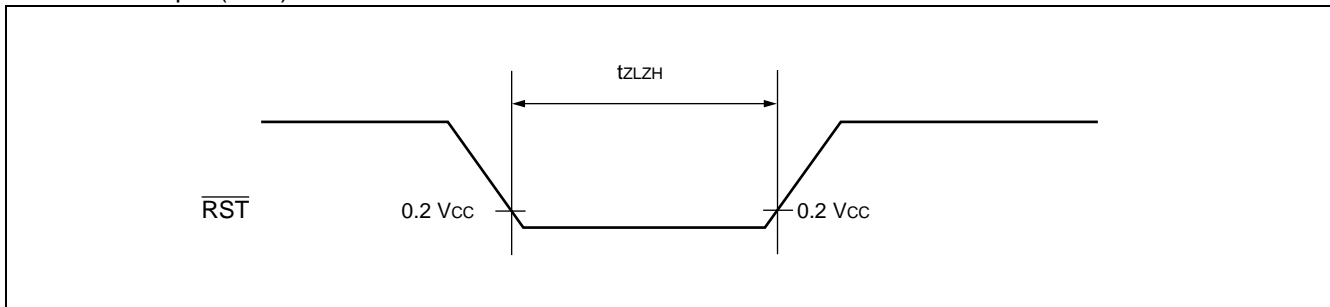

(2) Power-on Reset

($A_{VSS} = V_{SS} = 0\text{ V}$, $T_A = -40\text{ }^\circ\text{C}$ to $+85\text{ }^\circ\text{C}$)

Parameter	Symbol	Condition	Value		Unit	Remarks
			Min	Max		
Power on time	t_{R}	—	0.5	50	ms	
Power shutoff time	t_{OFF}	—	1	—	ms	For repeated operation

Note : Be sure that the power supply will come on within the selected oscillator stabilization period. Also, when varying the supply voltage during operation, it is recommended that the supply voltage be increased gradually.

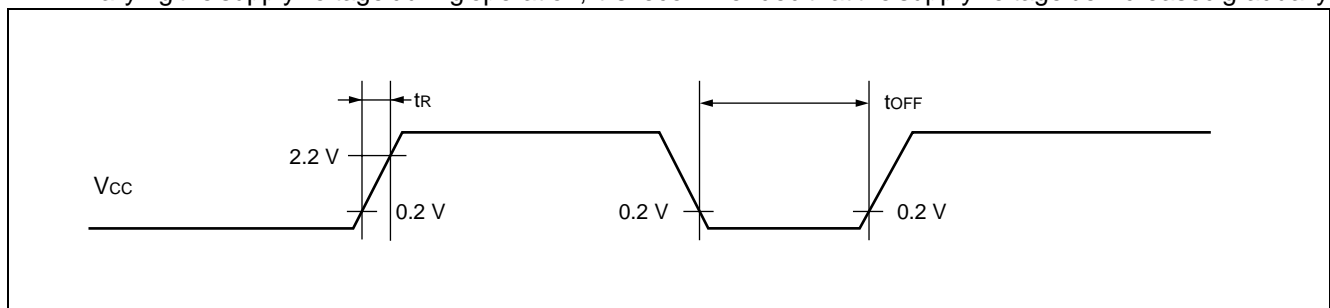

(3) Clock Timing Standards

(AV_{SS} = V_{SS} = 0 V, T_A = -40 °C to +85 °C)

Parameter	Symbol	Pin name	Condition	Value			Unit	Remarks
				Min	Typ	Max		
Clock frequency	F _{CH}	X0, X1	—	1	—	12.5	MHz	Main clock
	F _{CL}	X0A, X1A		—	32.768	—	kHz	Sub clock
Clock cycle time	t _{HCYL}	X0, X1		80	—	1000	ns	Main clock
	t _{LCYL}	X0A, X1A		—	30.5	—	μs	Sub clock
Input clock pulse width	P _{WH} P _{WL}	X0		20	—	—	ns	External clock
	P _{WHH} P _{WLL}	X0A		—	15.2	—	μs	External clock
Input clock rise, fall time	t _{CR} t _{CF}	X0	—	—	10	ns	External clock	

- X0, X1 timing and application conditions

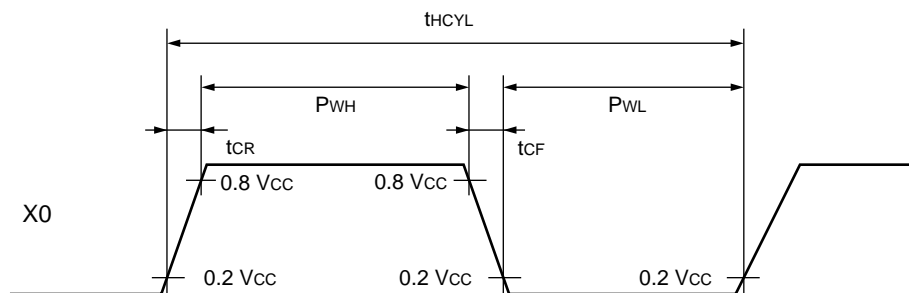

- Clock application conditions

Using a crystal oscillator
or
ceramic oscillator

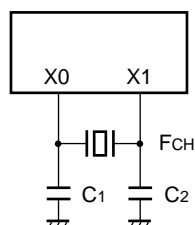

Using an external clock
signal

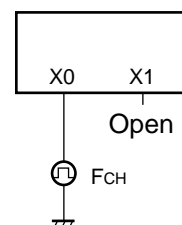

MB89530 Series

- X0A, X1A timing and application conditions

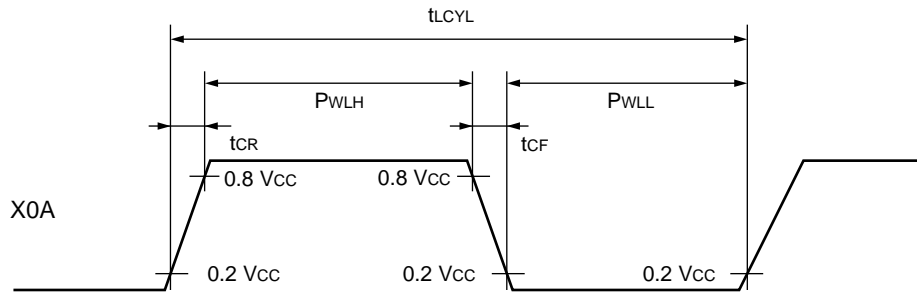

- Clock application conditions

Using a crystal oscillator
or
ceramic oscillator

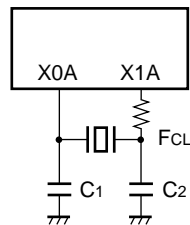

Using an external clock
signal

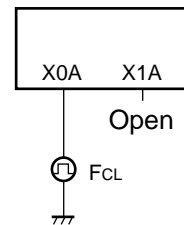

(4) Instruction Cycle

(A_{VSS} = V_{SS} = 0 V, T_A = -40 °C to +85 °C)

Parameter	Symbol	Rated value	Unit	Remarks
Instruction cycle (minimum instruction execution time)	t _{inst}	4/F _{CH} , 8/F _{CH} , 16/F _{CH} , 64/F _{CH}	μs	Operating at F _{CH} = 12.5 MHz (4/F _{CH}) t _{inst} = 0.32 μs
		2/F _{CL}	μs	Operating at F _{CL} = 32.768 kHz t _{inst} = 61.036 μs

(5) Serial I/O Timing

($V_{CC} = 3.0\text{ V}$, $A/V_{SS} = V_{SS} = 0\text{ V}$, $T_A = -40\text{ }^\circ\text{C}$ to $+85\text{ }^\circ\text{C}$)

Parameter	Symbol	Pin name	Condition	Value		Unit	Remarks
				Min	Max		
Serial clock cycle time	t_{SCYC}	SCK, UCK	Internal clock operation	$2 t_{inst}$	—	μs	
SCK \downarrow →SO	t_{SLOV}	SCK, SO, UCK, UO		-200	+200	ns	
Valid SI→SCK \uparrow	t_{VSH}	SI, SCK, UI, UCK		200	—	ns	
SCK \uparrow → valid SI hold time	t_{SHIX}	SCK, SI, UCK, UI		200	—	ns	
Serial clock "H" pulse width	t_{SHSL}	SCK, UCK	External clock operation	$1 t_{inst}$	—	μs	
Serial clock "L" pulse width	t_{LSLH}			$1 t_{inst}$	—	μs	
SCK \downarrow →SO time	t_{SLOV}	SCK, SO, UCK, UO		0	200	ns	
Valid SI→SCK \uparrow	t_{VSH}	SI, SCK, UI, UCK		200	—	ns	
SCK \uparrow → valid SI hold time	t_{SHIX}	SCK, SI, UCK, UI	200	—	ns		

Note : For t_{inst} see "(4) Instruction Cycle".

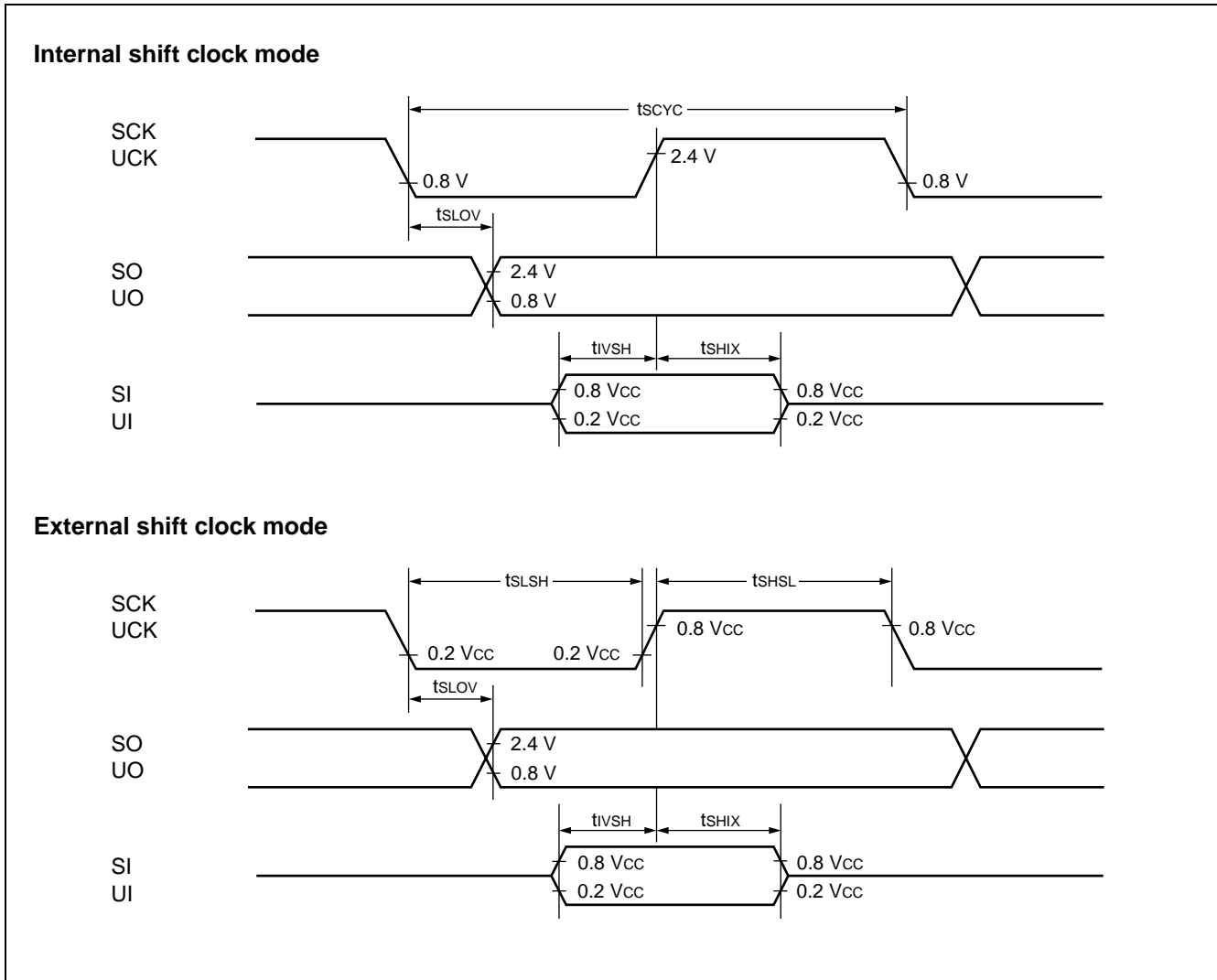

MB89530 Series

(6) Peripheral Input Timing

($V_{CC} = 3.0\text{ V}$, $A/V_{SS} = V_{SS} = 0\text{ V}$, $T_A = -40\text{ }^{\circ}\text{C}$ to $+85\text{ }^{\circ}\text{C}$)

Parameter	Symbol	Pin name	Condition	Value		Unit	Remarks
				Min	Max		
Peripheral input "H" level pulse width 1	t_{LIH1}	INT10 to INT13, INT20 to INT27, EC, PWC, PWCK	—	$2 t_{inst}$	—	μs	
Peripheral input "L" level pulse width 1	t_{HIL1}		—	$2 t_{inst}$	—	μs	
Peripheral input "H" level pulse width 2	t_{LIH2}	ADST	—	$2^8 t_{inst}$	—	μs	
Peripheral input "L" level pulse width 2	t_{HIL2}		—	$2^8 t_{inst}$	—	μs	

Note : For t_{inst} see "(4) Instruction Cycle".

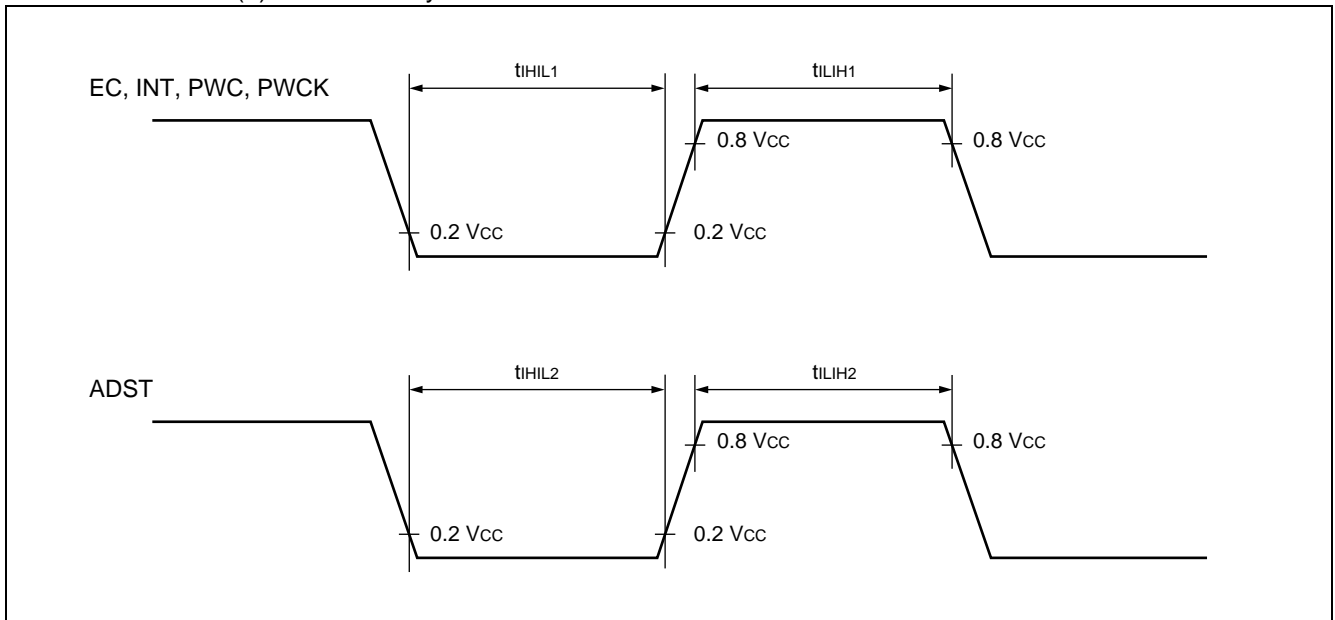

(7) I²C Timing

(V_{CC} = 3.0 V, AV_{SS} = V_{SS} = 0 V, T_A = -40 °C to +85 °C)

Parameter	Symbol	Pin name	Condition	Value		Unit	Remarks
				Min	Max		
Start condition output	t _{STA}	SCL SDA	—	$1 / 4 t_{inst} \times m \times n - 20$	$1 / 4 t_{inst} \times m \times n + 20$	ns	Master only
Stop condition output	t _{STO}	SCL SDA	—	$1 / 4 t_{inst} \times (m \times n + 8) - 20$	$1 / 4 t_{inst} \times (m \times n + 8) + 20$	ns	Master only
Start condition detection	t _{STA}	SCL SDA	—	$1 / 4 t_{inst} \times 6 + 40$	—	ns	
Stop condition detection	t _{STO}	SCL SDA	—	$1 / 4 t_{inst} \times 6 + 40$	—	ns	
Restart condition output	t _{STASU}	SCL SDA	—	$1 / 4 t_{inst} \times (m \times n + 8) - 20$	$1 / 4 t_{inst} \times (m \times n + 8) + 20$	ns	Master only
Restart condition detection	t _{STASU}	SCL SDA	—	$1 / 4 t_{inst} \times 4 + 40$	—	ns	
SCL output “L” width	t _{LOW}	SCL	—	$1 / 4 t_{inst} \times m \times n - 20$	$1 / 4 t_{inst} \times m \times n + 20$	ns	Master only
SCL output “H” width	t _{HIGH}	SCL	—	$1 / 4 t_{inst} \times (m \times n + 8) - 20$	$1 / 4 t_{inst} \times (m \times n + 8) + 20$	ns	Master only
SDA output delay time	t _{DO}	SDA	—	$1 / 4 t_{inst} \times 4 - 20$	$1 / 4 t_{inst} \times 4 + 20$	ns	
Setup after SDA output interrupt interval	t _{DOSU}	SDA	—	$1 / 4 t_{inst} \times 4 - 20$	—	ns	
SCL input “L” width	t _{LOW}	SCL	—	$1 / 4 t_{inst} \times 6 + 40$	—	ns	
SCL input “H” width	t _{HIGH}	SCL	—	$1 / 4 t_{inst} \times 2 + 40$	—	ns	
SDA input setup	t _{SU}	SDA	—	40	—	ns	
SDA input hold	t _{HO}	SDA	—	0	—	ns	

Notes : • For t_{inst} see “ (4) Instruction Cycle”.

- The value “m” in the above table is the value from the shift clock frequency setting bits (CS4-CS3) in the clock control register “ICCR”. For details, refer to the register description in the hardware manual.
- The value ‘n’ in the above table is the value from the shift clock frequency setting bits (CS2-CS0) in the clock control register “ICCR”. For details, refer to the register description in the hardware manual.
- t_{DOSU} appears when the interrupt period is longer than the SCL “L” width.
- The rated values for SDA and SCL assume a start up time of 0 ns.

MB89530 Series

- I²C interface [Data sending (master/slave)]

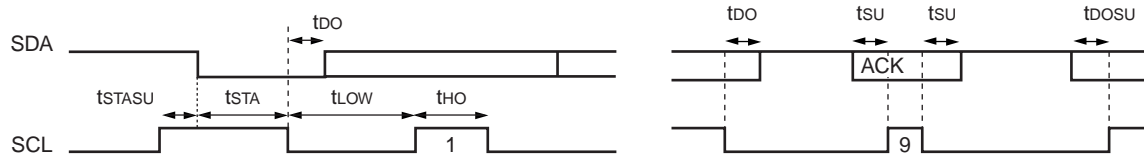

- I²C interface [Data sending (master/slave)]

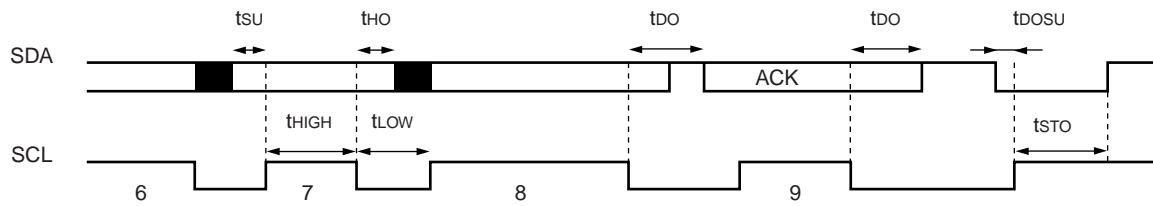

5. A/D Converter Electrical Characteristics

(1) MB89537/538/537C/538C

($V_{CC} = 2.4 \text{ V to } 3.6 \text{ V}$, $AV_{SS} = V_{SS} = 0 \text{ V}$, $T_A = -40 \text{ }^\circ\text{C to } +85 \text{ }^\circ\text{C}$)

Parameter	Symbol	Pin name	Condition	Value			Unit	Remarks
				Min	Typ	Max		
Resolution capability	—	—	—	—	—	10	bit	AV _{CC} = V _{CC}
Total error				—	—	±3.0	LSB	
Linear error				—	—	±2.5	LSB	
Differential linear error				—	—	±1.9	LSB	
Zero transition voltage	V _{OT}	—	AVR = AV _{CC}	AV _{SS} - 1.5 LSB	AV _{SS} + 0.5 LSB	AV _{SS} + 2.5 LSB	mV	
Full scale transition voltage	V _{FST}			AVR - 3.5 LSB	AVR - 1.5 LSB	AVR + 1.5 LSB	mV	
Inter-channel variation	—	—	—	—	—	4.0	LSB	
Conversion time	—			—	60 t _{inst}	—	μs	*
Sampling time	—			—	16 t _{inst}	—	μs	
Analog input current	I _{AIN}			AN0 to AN7	—	—	—	10
Analog input voltage	V _{AIN}	AV _{SS}	—			AVR	V	
Reference voltage	—	AVR	—	AV _{SS} + 2.4	—	AV _{CC}	V	
Reference voltage supply current	I _R			A/D running	—	200	—	μA
	I _{RH}			A/D off	—	—	5	μA

* : Includes sampling time

(2) MB89F538L

($V_{CC} = 2.4 \text{ V to } 3.6 \text{ V}$, $AV_{SS} = V_{SS} = 0 \text{ V}$, $T_A = -40 \text{ }^\circ\text{C to } +85 \text{ }^\circ\text{C}$)

Parameter	Symbol	Pin name	Condition	Value			Unit	Remarks
				Min	Typ	Max		
Resolution capability	—	—	—	—	—	10	bit	AV _{CC} = V _{CC}
Total error				—	—	±3.0	LSB	
Linear error				—	—	±2.5	LSB	
Differential linear error				—	—	±1.9	LSB	
Zero transition voltage	V _{OT}	—	AVR = AV _{CC}	AV _{SS} - 1.5 LSB	AV _{SS} + 0.5 LSB	AV _{SS} + 2.5 LSB	mV	
Full scale transition voltage	V _{FST}			AVR - 3.5 LSB	AVR - 1.5 LSB	AVR + 1.5 LSB	mV	
Inter-channel variation	—	—	—	—	—	4.0	LSB	
Conversion time	—			—	60 t _{inst}	—	μs	*
Sampling time	—			—	16 t _{inst}	—	μs	
Analog input current	I _{AIN}			AN0 to AN7	—	—	—	10
Analog input voltage	V _{AIN}	0	—			AVR	V	
Reference voltage	—	AVR	—	AV _{SS} + 2.4	—	AV _{CC}	V	
Reference voltage supply current	I _R			A/D running	—	200	—	μA
	I _{RH}			A/D off	—	—	5	μA

* : Includes sampling time

MB89530 Series

(3) MB89P538/PV530

($V_{CC} = 2.4 \text{ V to } 3.6 \text{ V}$, $AV_{SS} = V_{SS} = 0 \text{ V}$, $T_A = -40 \text{ }^\circ\text{C to } +85 \text{ }^\circ\text{C}$)

Parameter	Symbol	Pin name	Condition	Value			Unit	Remarks		
				Min	Typ	Max				
Resolution capability	—	—	—	—	—	10	bit	$AV_{CC} = V_{CC}$		
Total error			—	—	± 3.0	LSB				
Linear error			—	—	± 2.5	LSB				
Differential linear error			—	—	± 1.9	LSB				
Zero transition voltage			V_{OT}	—	$AVR = AV_{CC}$	$AV_{SS} - 1.5$ LSB	$AV_{SS} + 0.5$ LSB		$AV_{SS} + 2.5$ LSB	mV
Full scale transition voltage			V_{FST}			$AVR - 3.5$ LSB	$AVR - 1.5$ LSB		$AVR + 1.5$ LSB	mV
Inter-channel variation			—	—	—	—	4.0		LSB	
Conversion time	—	—	—	—	$60 t_{inst}$	—	μs	*		
Sampling time	—			—	$16 t_{inst}$	—	μs			
Analog input current	I_{AIN}	AN0 to AN7	—	—	—	10	μA			
Analog input voltage	V_{AIN}	AN7	—	0	—	AVR	V			
Reference voltage	—	AVR	—	$AV_{SS} + 3.5$	—	AV_{CC}	V			
Reference voltage supply current	I_R	AVR	A/D running	—	400	—	μA			
	I_{RH}		A/D off	—	—	5	μA			

* : Includes sampling time

(4) A/D Converter Terms and Definitions

- Resolution

The level of analog variation that can be distinguished by the A/D converter.

- Linear error (unit : LSB)

The deviation between the value along a straight line connecting the zero transition point ("00 0000 0000" ↔ "00 0000 0001") of a device and the full-scale transition point ("11 1111 1110" ↔ "11 1111 1111"), compared with the actual conversion values obtained.

- Differential linear error (Unit : LSB)

The deviation from the theoretical input voltage required to produce a change of 1 LSB in output code.

- Total error (Unit : LSB)

The difference between theoretical conversion value and actual conversion value.

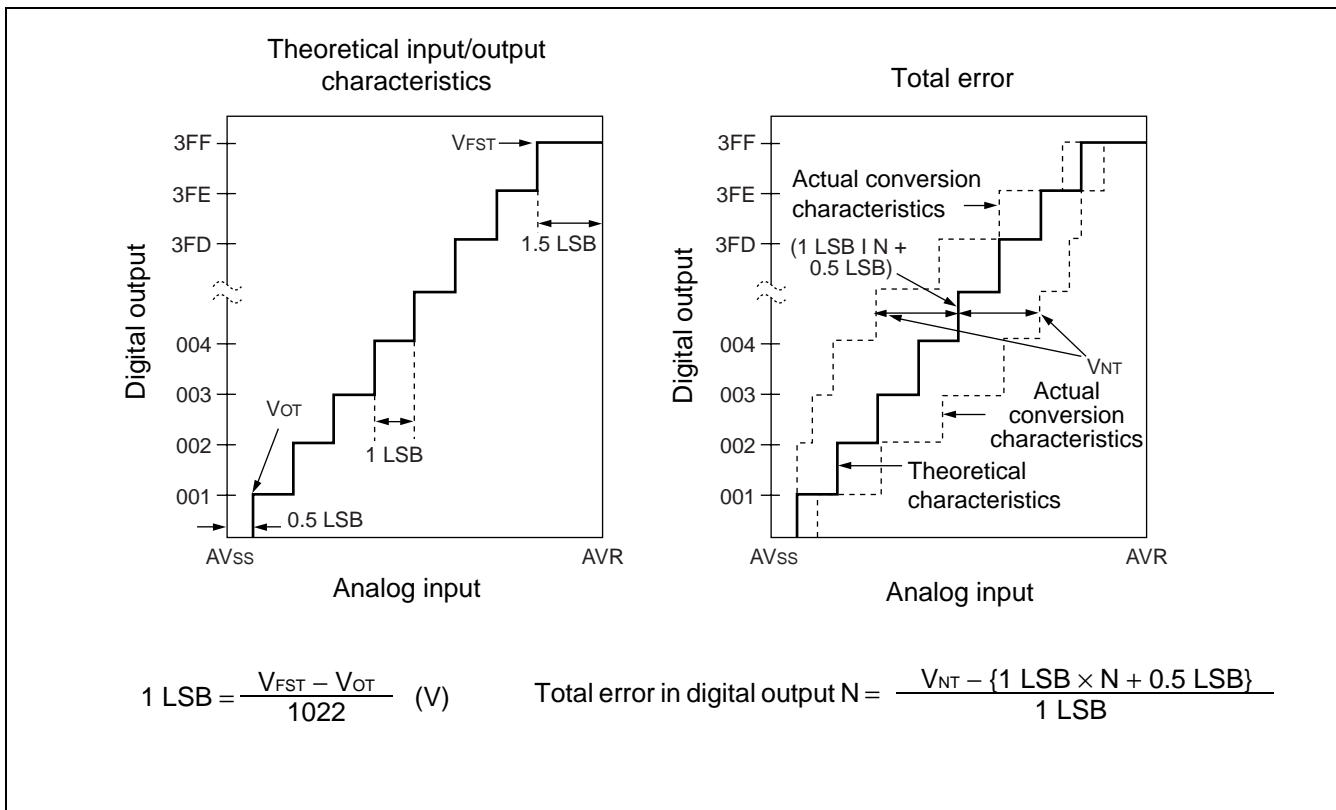

(Continued)

MB89530 Series

(Continued)

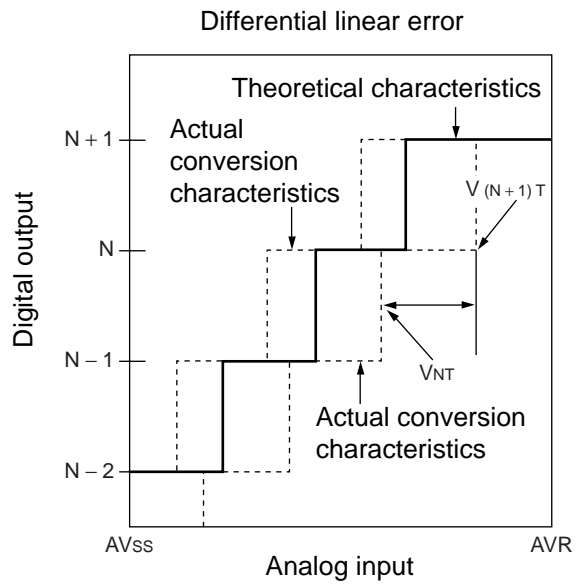
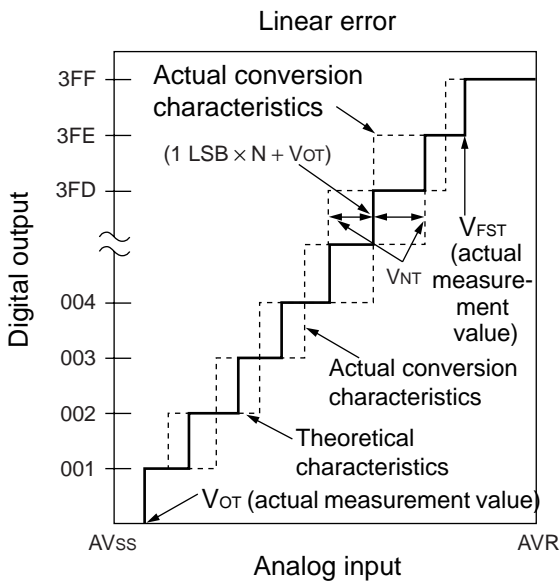
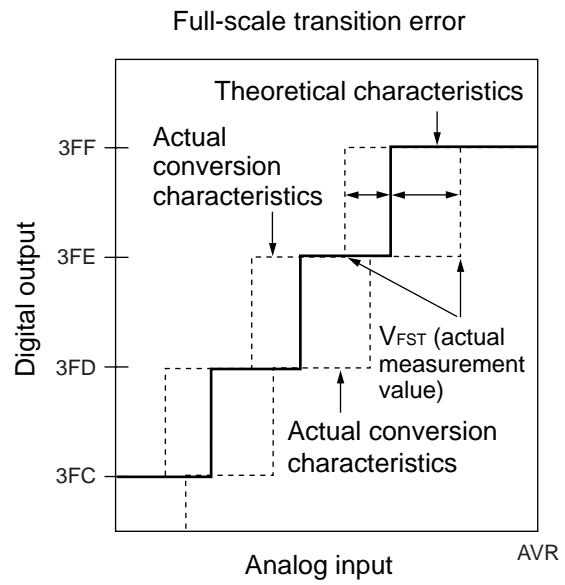
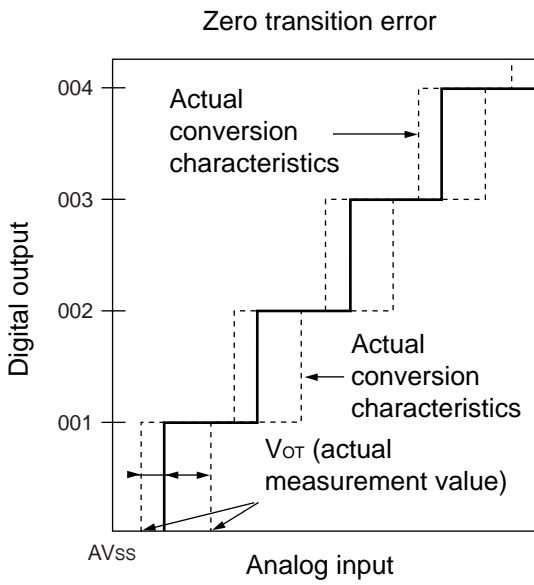

Analog input linear error in digital output N = $\frac{V_{NT} - \{1 \text{ LSB} \times N + V_{OT}\}}{1 \text{ LSB}}$

Differential linear error in digital output N = $\frac{V_{(N+1)T} - V_{NT}}{1 \text{ LSB}} - 1$

(5) Precautionary Information

• Input Impedance of Analog Input Pins

The A/D converter has a sample & hold circuit as shown below, which uses a sample-and-hold capacitor to obtain the voltage at the analog input pin for 8 instruction cycles following the start of A/D conversion. For this reason if the external circuits providing the analog input signal have high output impedance, the analog input voltage may not stabilize within the analog input sampling time. It is therefore recommended that the output impedance of external circuits be reduced to 10 k Ω or less.

• MB89537/537C/538/538C/F538L Analog Input Equivalent Circuit

If analog input impedance is 10 k Ω or more, the use of a capacitor of approximately 0.1 μ F is recommended.

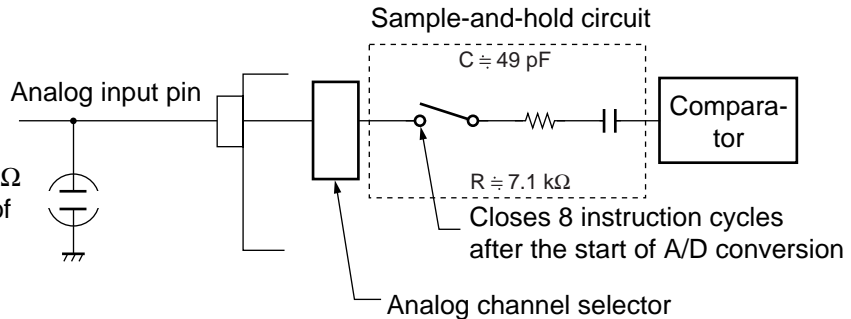

• MB89P538 and MB89PV530 Analog Input Equivalent Circuit

If analog input impedance is 10 k Ω or more, the use of a capacitor of approximately 0.1 μ F is recommended.

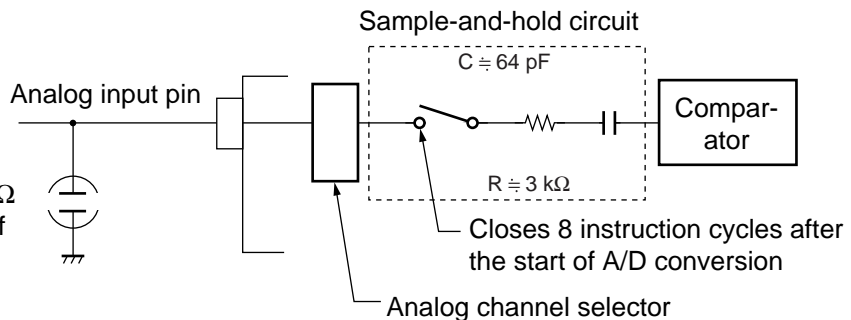

• About error

The smaller the absolute value $|AVR - AV_{SS}|$ is, the greater the relative error becomes.

MB89530 Series

6. Flash Memory

- Flash memory programming/erase characteristics

Parameter		Conditions	Value			Unit	Remarks
			Min	Typ	Max		
Sector erase time	Per 1 sector, Constant value independent with sector capacitance	T _A = +25 °C, V _{CC} = 3.3 V	—	1	15	s	*
Programming time	Per 1 byte		—	8	3600	μs	
Chip erase time			—	5	—	s	*
Program/Erase cycle		—	10,000	—	—	cycle	

* : Excludes internal programming time before erase.

EXAMPLE CHARACTERISTICS

(1) Power Supply Current (External Clock)

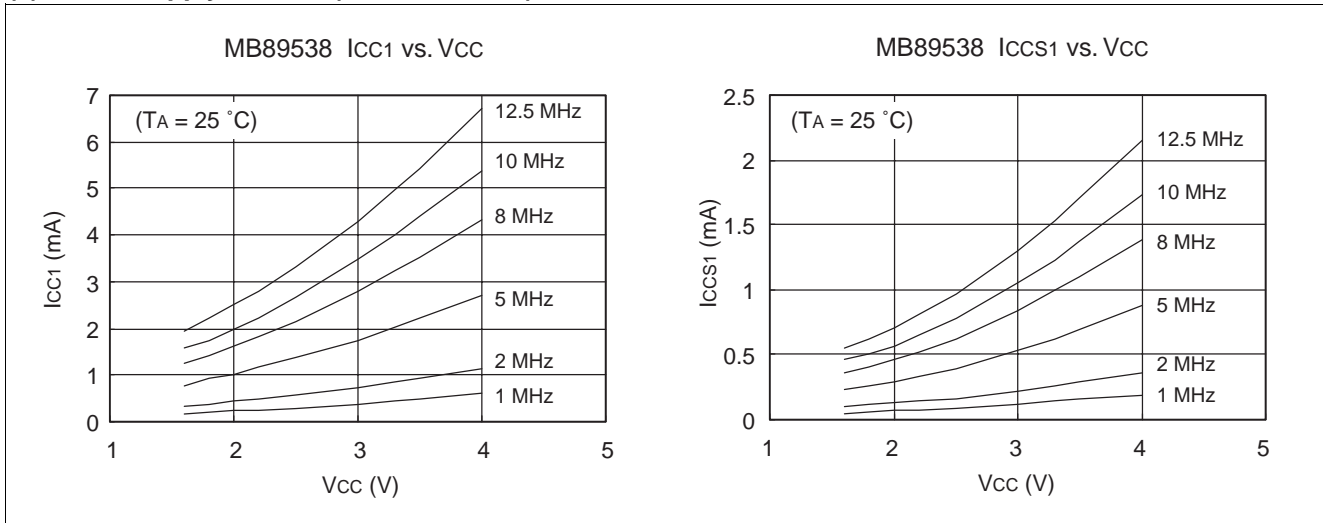

(2) "H" Level Input Voltage/ "L" Level Input Voltage (CMOS Input)

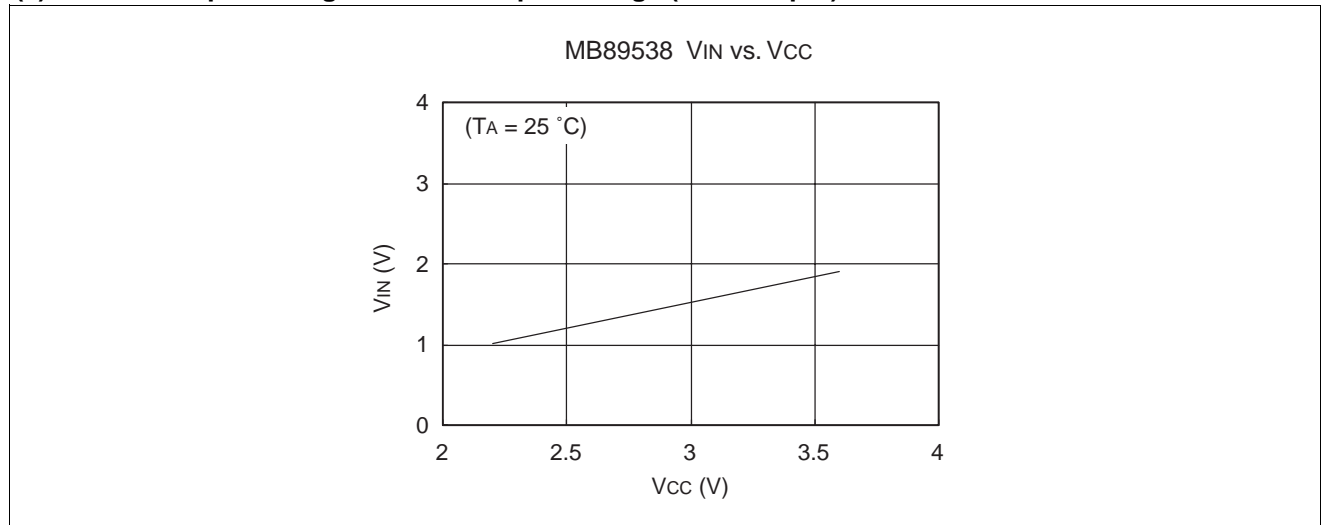

(3) "H" Level Input Voltage / "L" Level Input Voltage (Hysteresis Input)

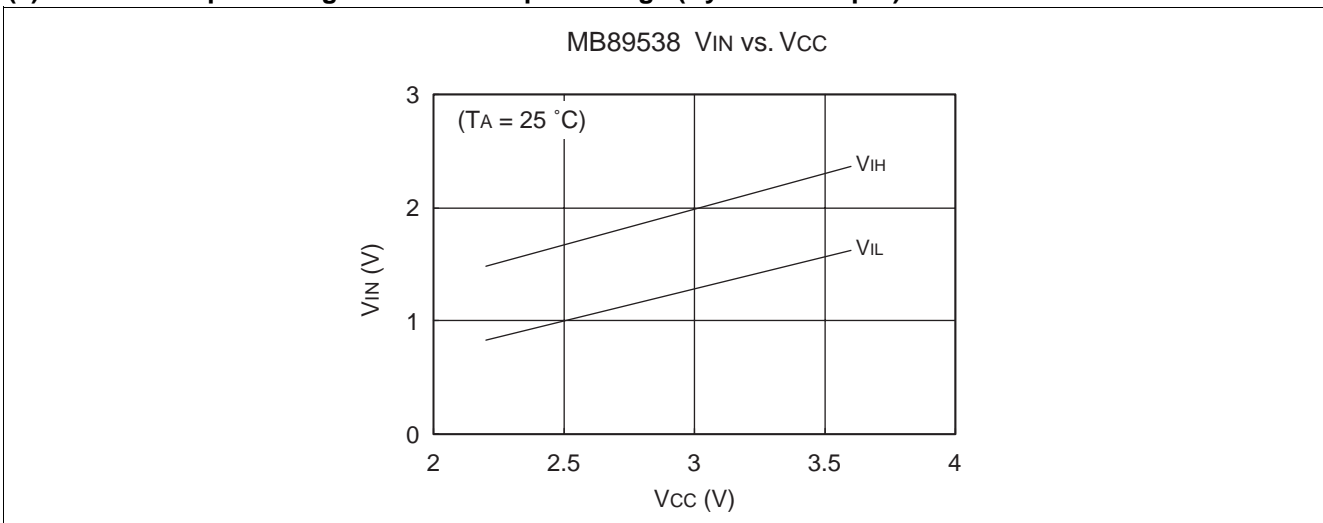

MB89530 Series

(4) AD Converter Characteristic Example

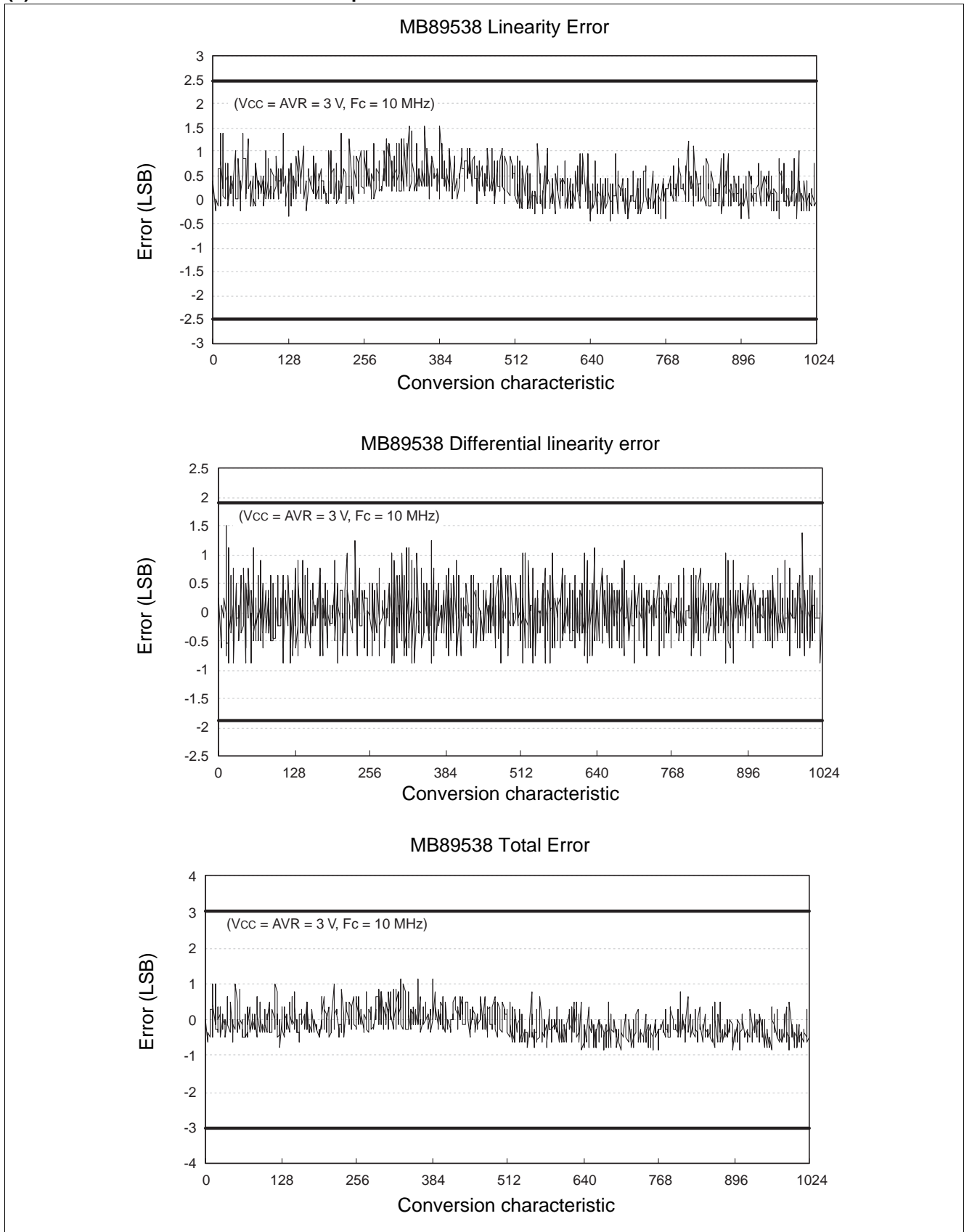

■ MASK OPTIONS

No	Part number	MB89537 MB89537C MB89538 MB89538C	MB89F538L-101 MB89F538L-201	MB89P538-101 MB89P538-201	MB89PV530-101 MB89PV530-201
	Method of specification	Specify at time of mask order	Setting not possible	Setting not possible	Setting not possible
1	Main clock Select oscillator stabilization wait period ($F_{CH}^* = 10 \text{ MHz}$) approx. $2^{14}/F_{CH}^*$ (approx.1.6 ms) approx. $2^{17}/F_{CH}^*$ (approx.13.1 ms) approx. $2^{18}/F_{CH}^*$ (approx.26.2 ms)	Selection available	$2^{18}/F_{CH}^*$ (approx. 26.2 ms)	$2^{18}/F_{CH}^*$ (approx. 26.2 ms)	$2^{18}/F_{CH}^*$ (approx. 26.2 ms)
2	Clock mode selection • 2-system clock mode • 1-system clock mode	Selection available	<ul style="list-style-type: none"> • 101 : 1-system clock mode • 201 : 2-system clock mode 		

* : F_{CH} : Main clock frequency

MB89530 Series

■ ORDERING INFORMATION

Part number	Package	Remarks
MB89537P MB89537CP MB89538P MB89538CP MB89F538L-101P MB89F538L-201P MB89P538-101P MB89P538-201P	DIP-64P-M01	MB89537P and MB89538P do not have I ² C functions.
MB89537PF MB89537CPF MB89538PF MB89538CPF MB89F538L-101PF MB89F538L-201PF MB89P538-101PF MB89P538-201PF	FPT-64P-M06	MB89537PF and MB89538PF do not have I ² C functions.
MB89537PFM MB89537CPF MB89538PFM MB89538CPF MB89F538L-101PFM MB89F538L-201PFM MB89P538-101PFM MB89P538-201PFM	FPT-64P-M09	MB89537PFM and MB89538PFM do not have I ² C functions.
MB89537PFV MB89537CPFV MB89538PFV MB89538CPFV	FPT-64P-M03	MB89537PFV and MB89538PFV do not have I ² C functions.
MB89F538L-101PV4 MB89F538L-201PV4	LCC-64P-M19	
MB89F538-101PV* MB89F538-201PV*	LCC-64P-M16*	
MB89PV530C-101 MB89PV530C-201	MDP-64C-P02	
MB89PV530CF-101 MB89PV530CF-201	MQP-64C-P01	

* : Only for ES

■ PACKAGE DIMENSIONS

64-pin, Plastic SH-DIP
(DIP-64P-M01)

Note: Pins width and pins thickness include plating thickness.

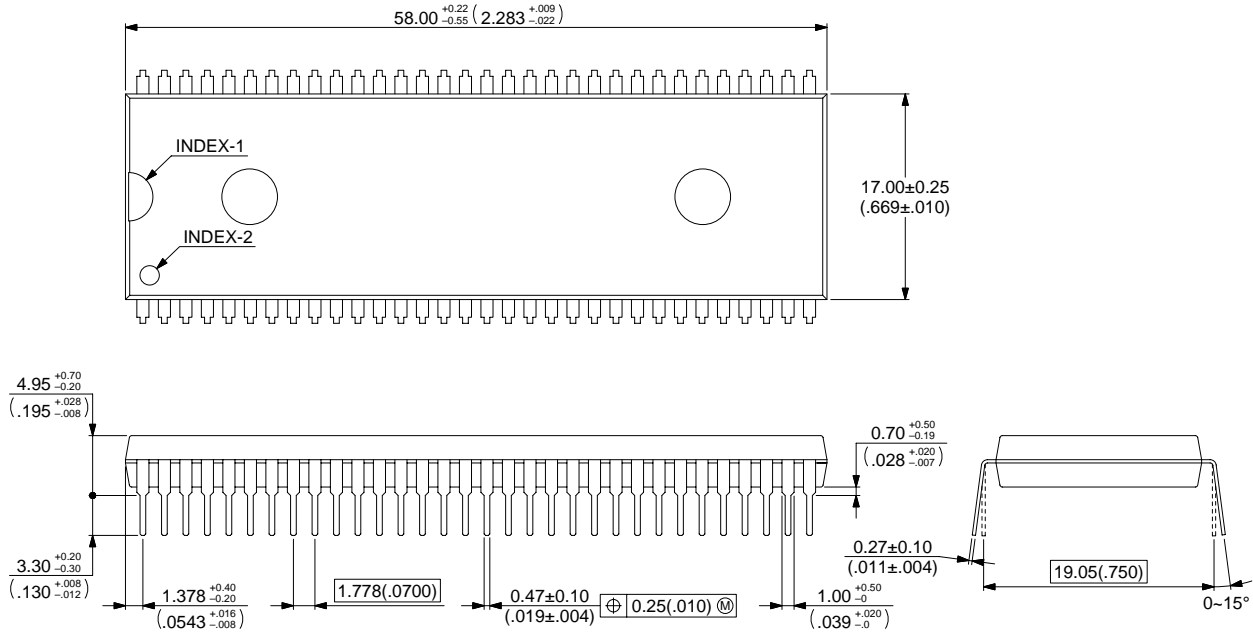

© 2001 FUJITSU LIMITED D64001S-c-4-5

Dimensions in mm (inches).
Note: The values in parentheses are reference values

(Continued)

MB89530 Series

64-pin, Plastic LQFP
(FPT-64P-M03)

Note 1) * : These dimensions do not include resin protrusion.
 Note 2) Pins width and pins thickness include plating thickness.
 Note 3) Pins width do not include tie bar cutting remainder.

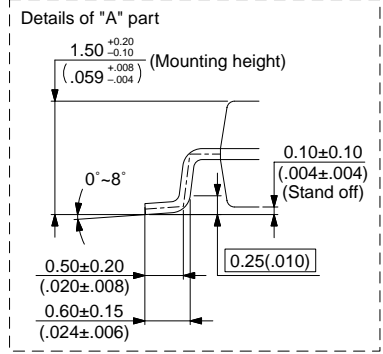
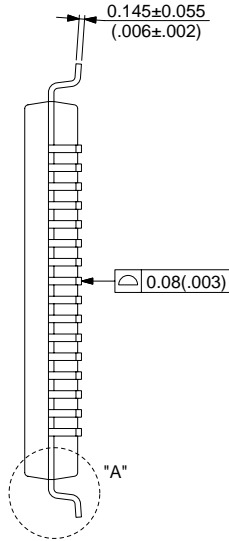
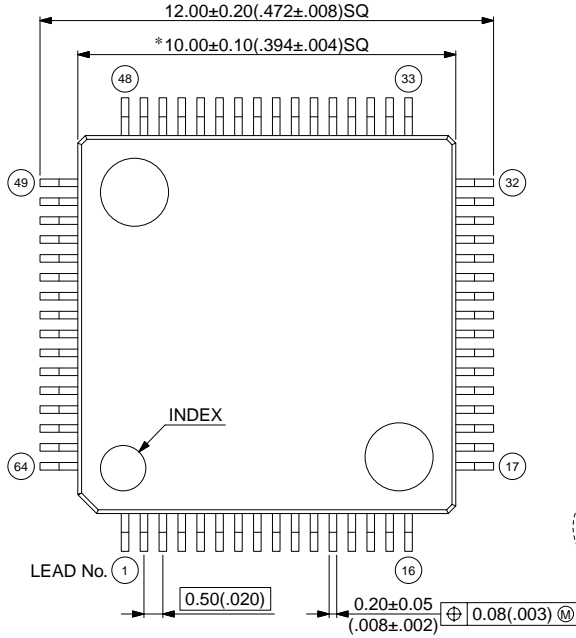

© 2003 FUJITSU LIMITED F64009S-c-5-8

Dimensions in mm (inches).
 Note: The values in parentheses are reference values

(Continued)

MB89530 Series

64-pin, Plastic QFP
(FPT-64P-M06)

Note 1) * : These dimensions do not include resin protrusion.
 Note 2) Pins width and pins thickness include plating thickness.
 Note 3) Pins width do not include tie bar cutting remainder.

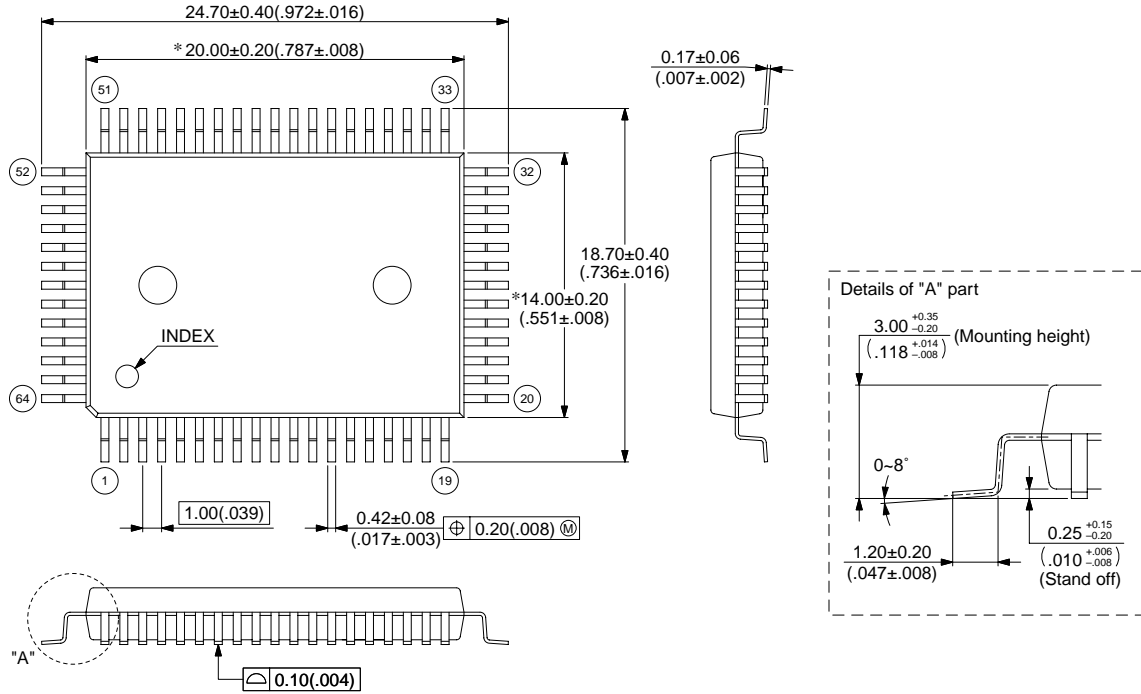

© 2003 FUJITSU LIMITED F64013S-c-5-5

Dimensions in mm (inches).
 Note: The values in parentheses are reference values

(Continued)

MB89530 Series

64-pin, Plastic LQFP
(FPT-64P-M09)

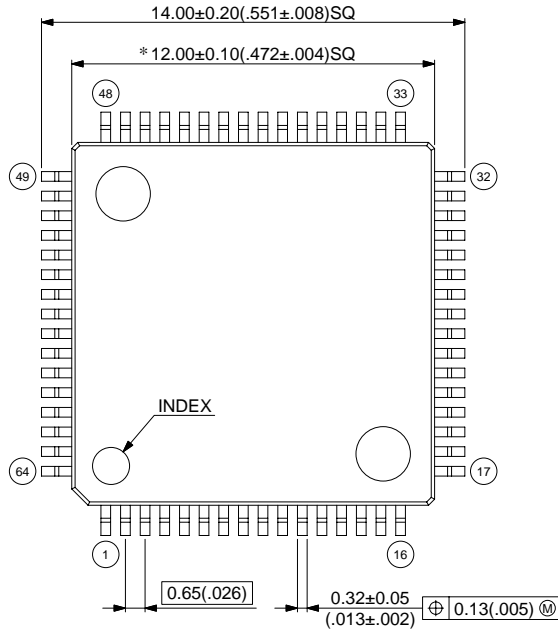

Note 1) * : These dimensions do not include resin protrusion.
 Note 2) Pins width and pins thickness include plating thickness.
 Note 3) Pins width do not include tie bar cutting remainder.

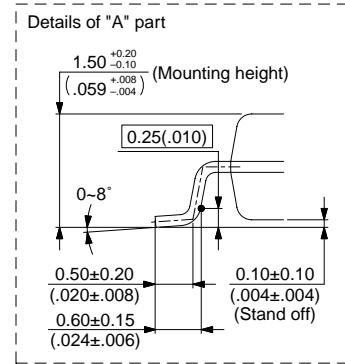
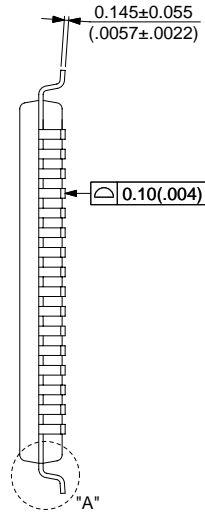

© 2003 FUJITSU LIMITED F64018S-c-3-5

Dimensions in mm (inches).
 Note: The values in parentheses are reference values

(Continued)

MB89530 Series

64-pin, Ceramic MDIP
(MDP-64C-P02)

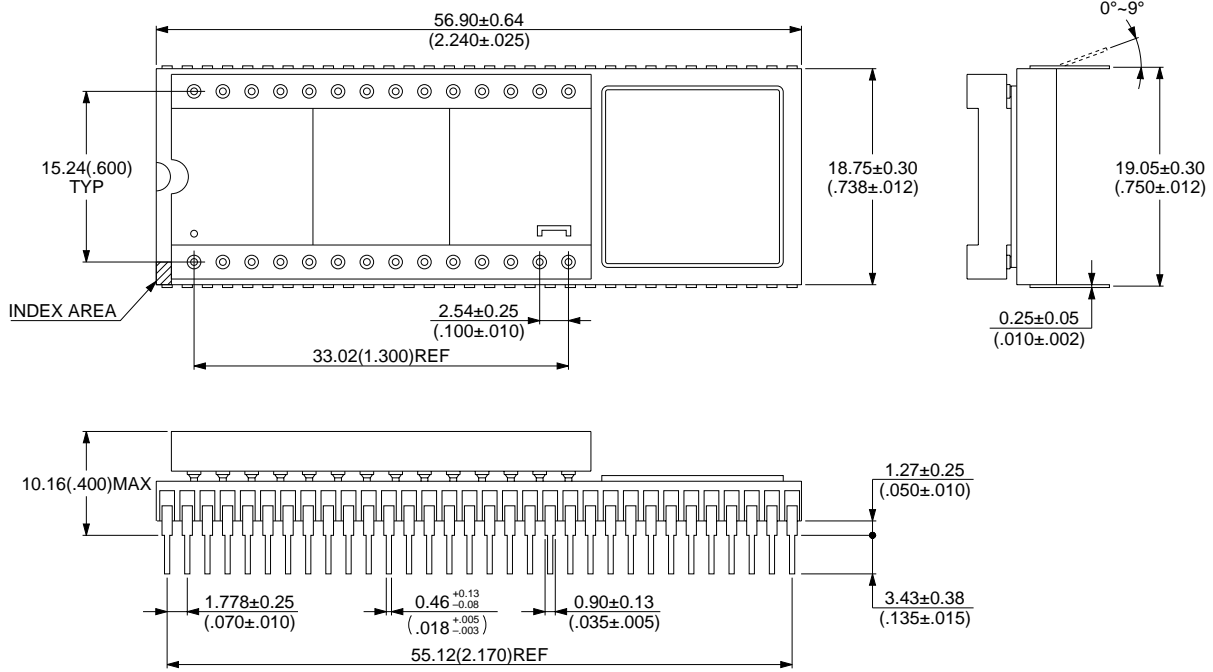

© 1994 FUJITSU LIMITED M64002SC-1-4

Dimensions in mm (inches).
Note: The values in parentheses are reference values

(Continued)

MB89530 Series

64-pin, Ceramic MQFP
(MQP-64C-P01)

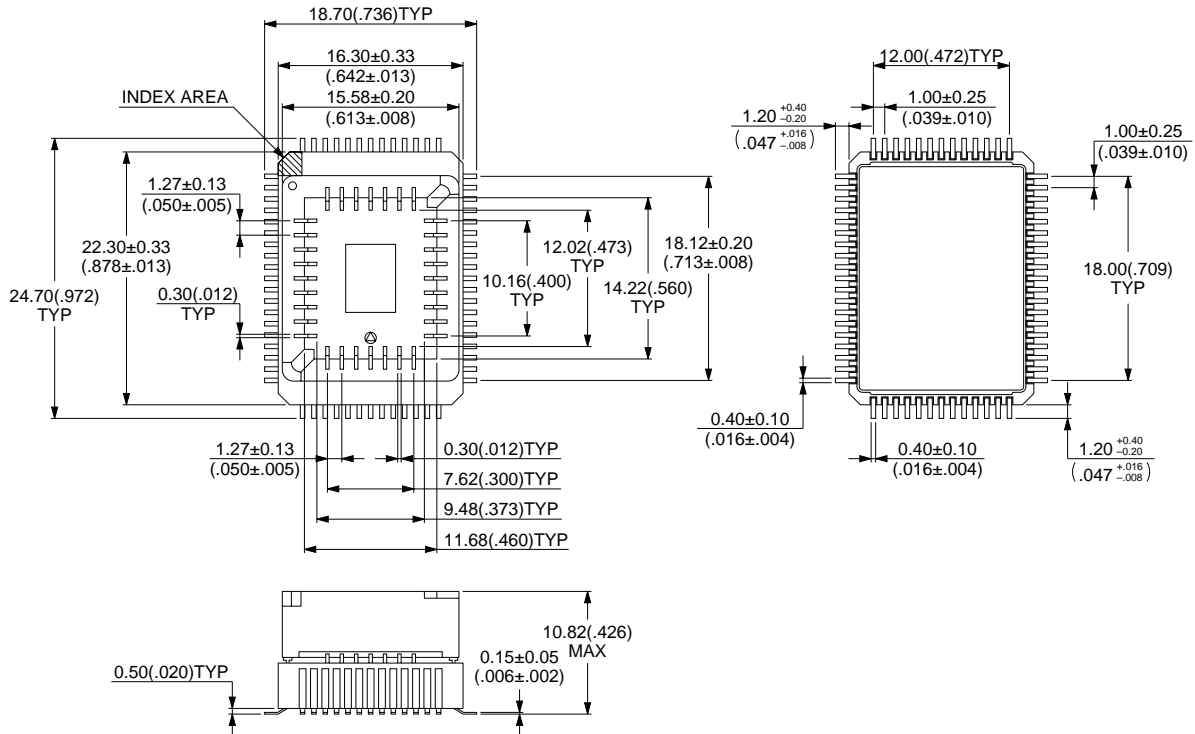

© 1994 FUJITSU LIMITED M64004SC-1-3

Dimensions in mm (inches).
Note: The values in parentheses are reference values

(Continued)

MB89530 Series

64-pin, Plastic BCC (LCC-64P-M19)

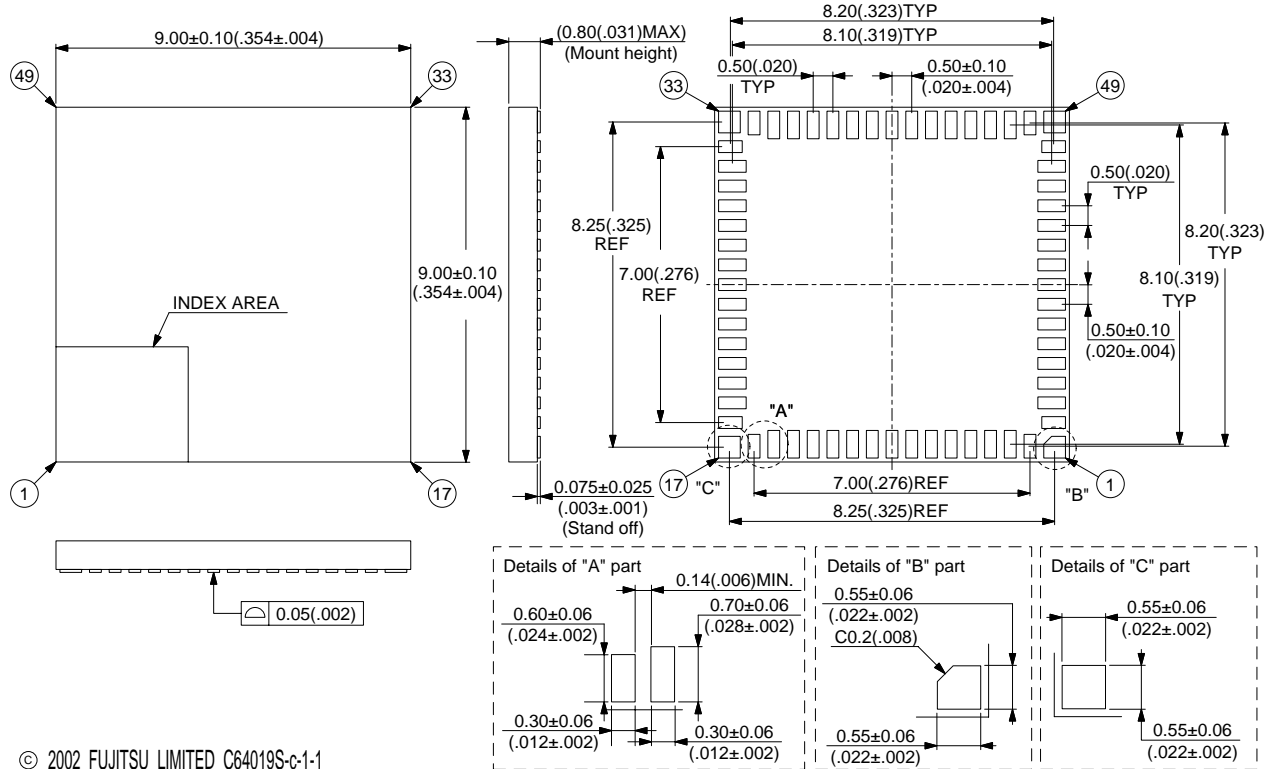

© 2002 FUJITSU LIMITED C64019S-c-1-1

Dimensions in mm (inches).
Note: The values in parentheses are reference values

(Continued)

MB89530 Series

(Continued)

64-pin, Plastic BCC
(LCC-64P-M16)

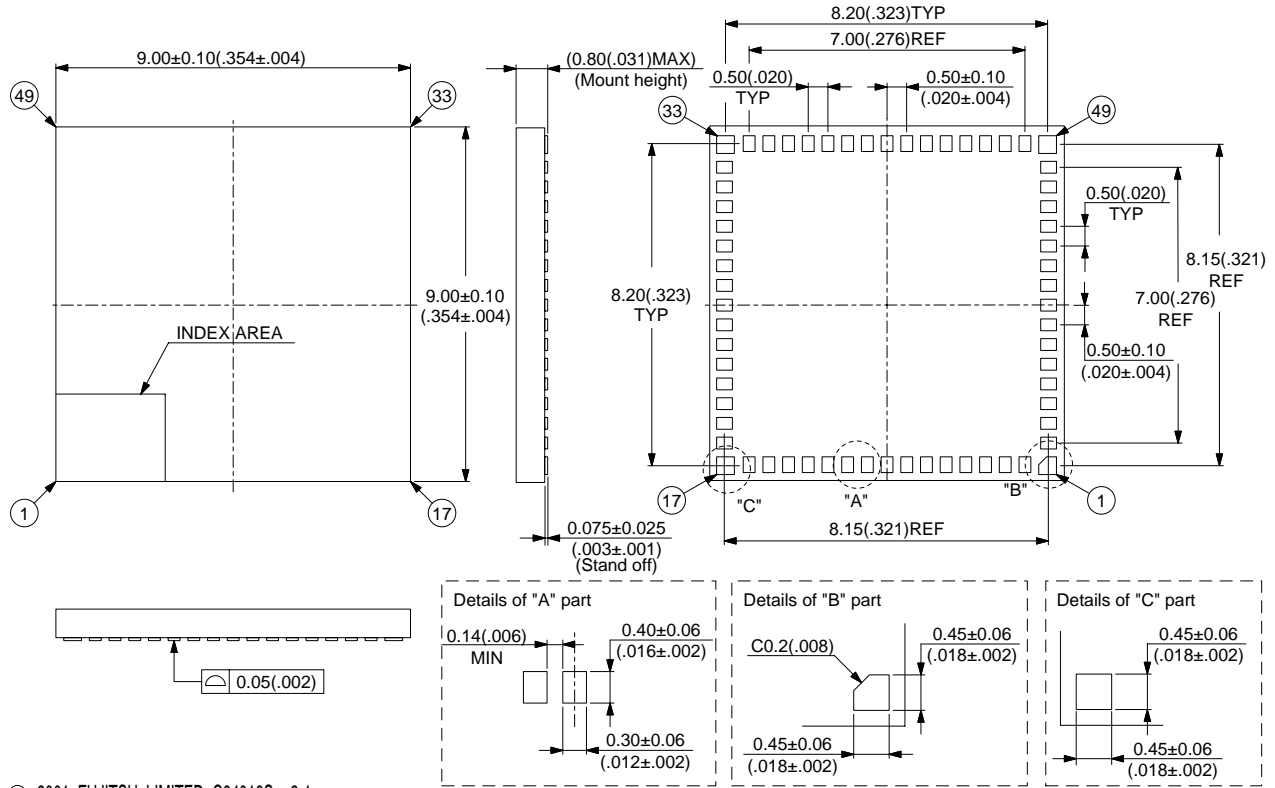

© 2001 FUJITSU LIMITED C64016S-c-2-1

Dimensions in mm (inches).
Note: The values in parentheses are reference values

FUJITSU LIMITED

All Rights Reserved.

The contents of this document are subject to change without notice. Customers are advised to consult with FUJITSU sales representatives before ordering.

The information, such as descriptions of function and application circuit examples, in this document are presented solely for the purpose of reference to show examples of operations and uses of Fujitsu semiconductor device; Fujitsu does not warrant proper operation of the device with respect to use based on such information. When you develop equipment incorporating the device based on such information, you must assume any responsibility arising out of such use of the information. Fujitsu assumes no liability for any damages whatsoever arising out of the use of the information.

Any information in this document, including descriptions of function and schematic diagrams, shall not be construed as license of the use or exercise of any intellectual property right, such as patent right or copyright, or any other right of Fujitsu or any third party or does Fujitsu warrant non-infringement of any third-party's intellectual property right or other right by using such information. Fujitsu assumes no liability for any infringement of the intellectual property rights or other rights of third parties which would result from the use of information contained herein.

The products described in this document are designed, developed and manufactured as contemplated for general use, including without limitation, ordinary industrial use, general office use, personal use, and household use, but are not designed, developed and manufactured as contemplated (1) for use accompanying fatal risks or dangers that, unless extremely high safety is secured, could have a serious effect to the public, and could lead directly to death, personal injury, severe physical damage or other loss (i.e., nuclear reaction control in nuclear facility, aircraft flight control, air traffic control, mass transport control, medical life support system, missile launch control in weapon system), or (2) for use requiring extremely high reliability (i.e., submersible repeater and artificial satellite).

Please note that Fujitsu will not be liable against you and/or any third party for any claims or damages arising in connection with above-mentioned uses of the products.

Any semiconductor devices have an inherent chance of failure. You must protect against injury, damage or loss from such failures by incorporating safety design measures into your facility and equipment such as redundancy, fire protection, and prevention of over-current levels and other abnormal operating conditions.

If any products described in this document represent goods or technologies subject to certain restrictions on export under the Foreign Exchange and Foreign Trade Law of Japan, the prior authorization by Japanese government will be required for export of those products from Japan.