



# 东莞市华远电子有限公司

DONG GUAN SHI HUA YUAN ELECTRON CO..LTD.

TEL: 86-769-5335378 86-769-5305266 FEX: 86-769-5316189

## TO-220 Plastic-Encapsulate Transistors

### MBR1530CT-MBR1560CT

SCHOTTKY BARRIER RECTIFIER

#### FEATURES

- Schottky Barrier Chip
- Guard Ring Die Construction for Transient Protection
- Low Power Loss, High Efficiency
- High Surge Capability
- High Current Capability and Low Forward Voltage Drop
- For Use in Low Voltage, High Frequency Inverters, Free Wheeling, and Polarity Protection Applications

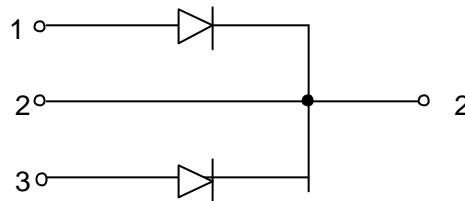
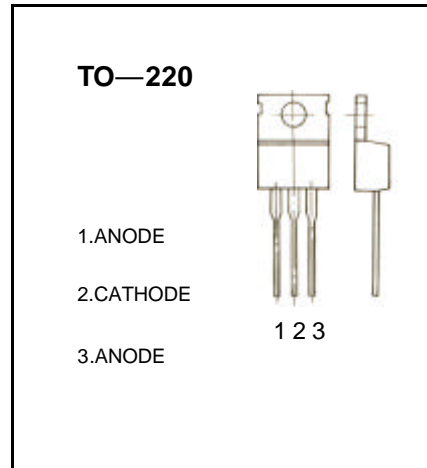

#### ELECTRICAL CHARACTERISTICS ( $T_{amb}=25$ unless otherwise specified )

Characteristic	Symbol	MBR 1530CT	MBR 1535CT	MBR 1540CT	MBR 1545CT	MBR 1550CT	MBR 1560CT	Unit
Peak Repetitive Reverse Voltage	$V_{RRM}$							
Working Peak Reverse Voltage	$V_{RWM}$	30	35	40	45	50	60	V
DC Blocking Voltage	$V_R$							
PMS Reverse Voltage	$V_{R(RMS)}$	21	24.5	28	31.5	35	42	V
Average Rectified Output Current (Note 1) @ $T_c=105$	$I_o$	15						A
Non-Repetitive Peak Forward Surge Current 8.3ms Single half sine-wave superimposed on rated load (JEDEC Method)	$I_{FSM}$	150						A
Forward Voltage Drop @ $I_F=7.5A, T_c=125$ @ $I_F=7.5A, T_c= 25$	$V_{FM}$		0.57			0.65		V
			0.70			0.75		
Peak Reverse Current @ $T_c= 25$ at Rated DC Blocking Voltage @ $T_c=125$	$I_{RM}$		0.1			1.0		mA
			15			50		
Typical Junction Capacitance (Note 2)	$C_j$	300						pF
Operating and Storage Temperature Range	$T_j, T_{STG}$	-65 to +150						

Notes: 1. Thermal resistance junction to case mounted heatsink.  
2. Measured at 1.0MHz and applied reverse voltage of 4.0V D

# Typical Characteristics

# MBR1530CT-MBR1560CT

FIG. 1 - FORWARD CURRENT DERATING CURVE

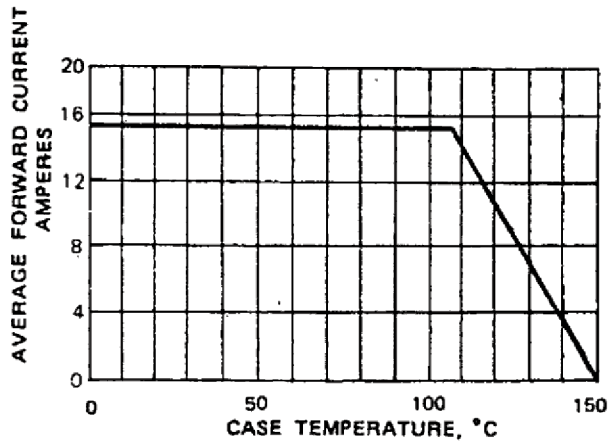

FIG. 3 - MAXIMUM NON-REPETITIVE SURGE CURRENT

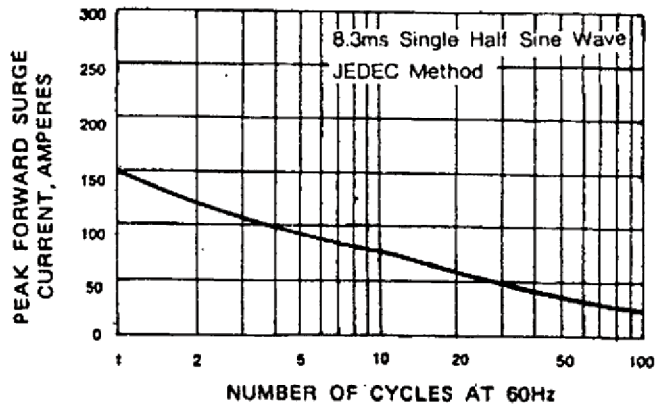

FIG. 2 - TYPICAL REVERSE CHARACTERISTICS

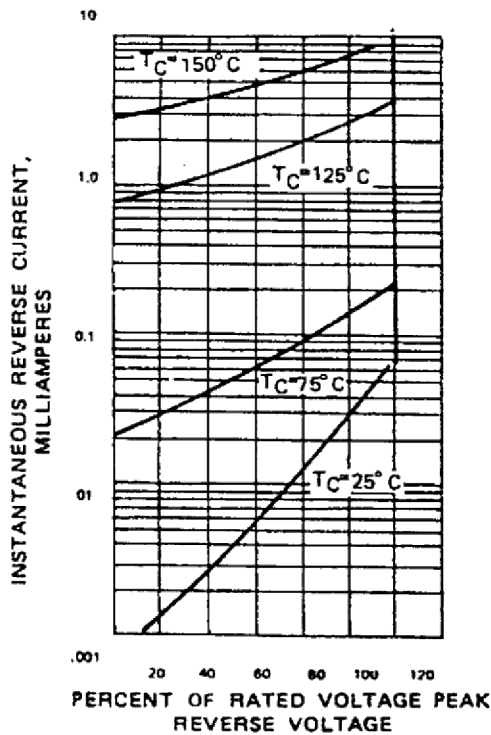

FIG. 4 - TYPICAL INSTANTANEOUS FORWARD CHARACTERISTICS

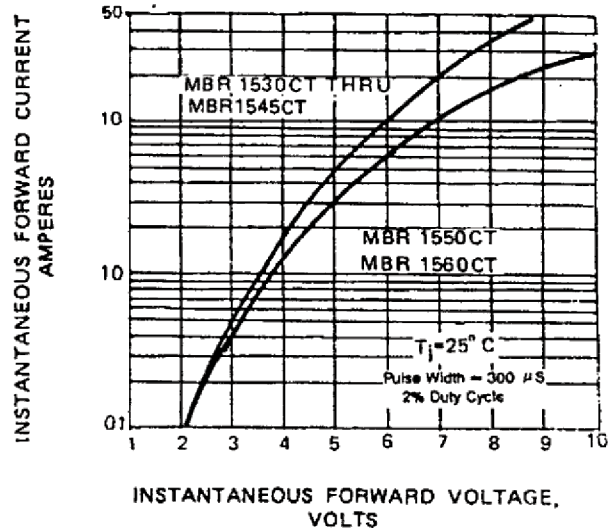
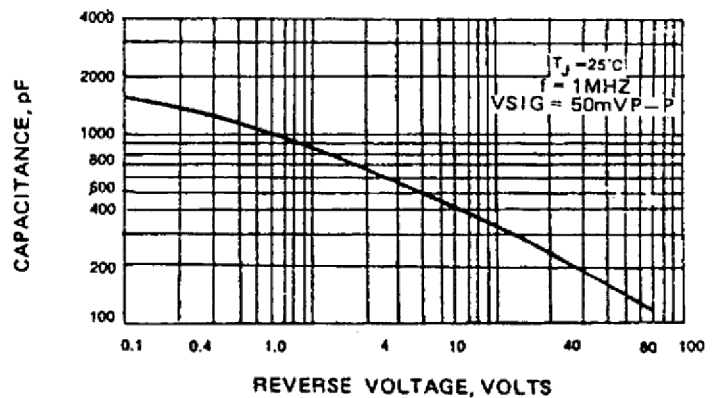
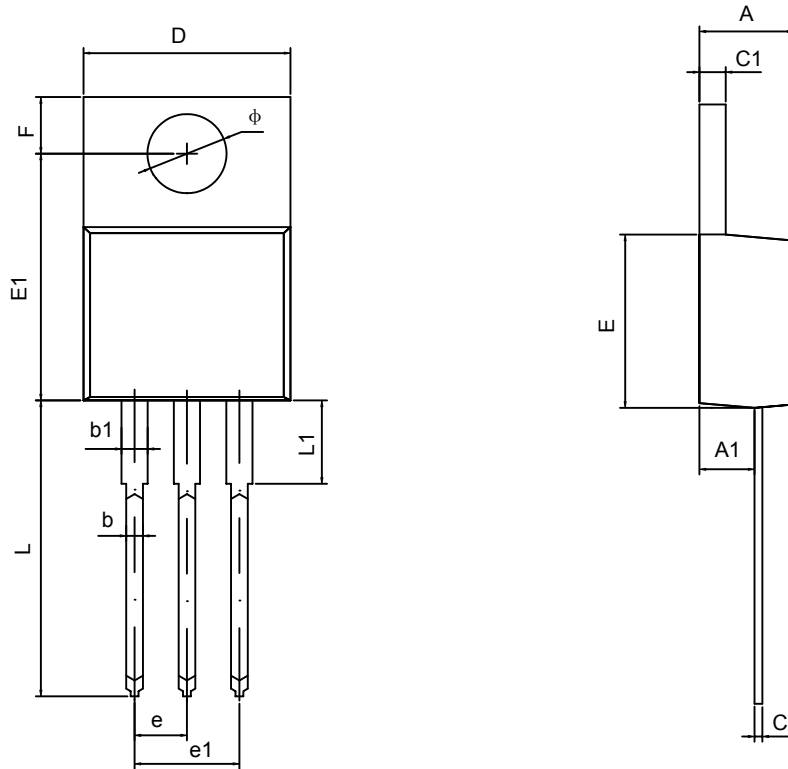

FIG. 5 - TYPICAL JUNCTION CAPACITANCE



## TO-220-3L PACKAGE OUTLINE DIMENSIONS



Symbol	Dimensions In Millimeters		Dimensions In Inches	
	Min	Max	Min	Max
A	4.470	4.670	1.176	0.184
A1	2.520	2.820	0.099	0.111
b	0.710	0.910	0.028	0.036
b1	1.170	1.370	0.046	0.054
c	0.310	0.530	0.012	0.021
c1	1.710	1.370	0.046	0.054
D	10.010	10.310	0.394	0.406
E	8.500	8.900	0.335	0.350
E1	12.060	12.460	0.475	0.491
e	2.540TYP		0.100TYP	
e1	4.980	5.180	0.196	0.204
F	2.590	2.890	0.102	0.114
L	13.400	13.800	0.528	0.543
L1	3.560	3.960	0.140	0.156
φ	3.790	3.890	0.149	0.153