

MC14001UB, MC14011UB

UB-Suffix Series CMOS Gates

The UB Series logic gates are constructed with P and N channel enhancement mode devices in a single monolithic structure (Complementary MOS). Their primary use is where low power dissipation and/or high noise immunity is desired. The UB set of CMOS gates are inverting non-buffered functions.

Features

- Supply Voltage Range = 3.0 Vdc to 18 Vdc
- Linear and Oscillator Applications
- Capable of Driving Two Low-Power TTL Loads or One Low-Power Schottky TTL Load Over the Rated Temperature Range
- Double Diode Protection on All Inputs
- Pin-for-Pin Replacements for Corresponding CD4000 Series UB Suffix Devices
- Pb-Free Packages are Available

MAXIMUM RATINGS (Voltages Referenced to V_{SS})

Symbol	Parameter	Value	Unit
V_{DD}	DC Supply Voltage Range	-0.5 to +18.0	V
V_{in}, V_{out}	Input or Output Voltage Range (DC or Transient)	-0.5 to $V_{DD} + 0.5$	V
I_{in}, I_{out}	Input or Output Current (DC or Transient) per Pin	± 10	mA
P_D	Power Dissipation, per Package (Note 1)	500	mW
T_A	Ambient Temperature Range	-55 to +125	$^{\circ}C$
T_{stg}	Storage Temperature Range	-65 to +150	$^{\circ}C$
T_L	Lead Temperature (8-Second Soldering)	260	$^{\circ}C$

Stresses exceeding Maximum Ratings may damage the device. Maximum Ratings are stress ratings only. Functional operation above the Recommended Operating Conditions is not implied. Extended exposure to stresses above the Recommended Operating Conditions may affect device reliability.

1. Temperature Derating:

Plastic "P and D/DW" Packages: - 7.0 mW/ $^{\circ}C$ From 65 $^{\circ}C$ To 125 $^{\circ}C$

This device contains protection circuitry to guard against damage due to high static voltages or electric fields. However, precautions must be taken to avoid applications of any voltage higher than maximum rated voltages to this high-impedance circuit. For proper operation, V_{in} and V_{out} should be constrained to the range $V_{SS} \leq (V_{in} \text{ or } V_{out}) \leq V_{DD}$.

Unused inputs must always be tied to an appropriate logic voltage level (e.g., either V_{SS} or V_{DD}). Unused outputs must be left open.



ON Semiconductor®

<http://onsemi.com>

MARKING DIAGRAMS

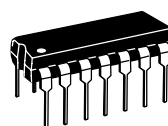

PDIP-14
P SUFFIX
CASE 646

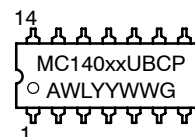

SOIC-14
D SUFFIX
CASE 751A

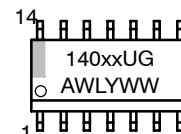

xx = Specific Device Code
A = Assembly Location
WL, L = Wafer Lot
YY, Y = Year
WW, W = Work Week
G = Pb-Free Package

ORDERING INFORMATION

See detailed ordering and shipping information in the package dimensions section on page 4 of this data sheet.

MC14001UB, MC14011UB

LOGIC DIAGRAMS

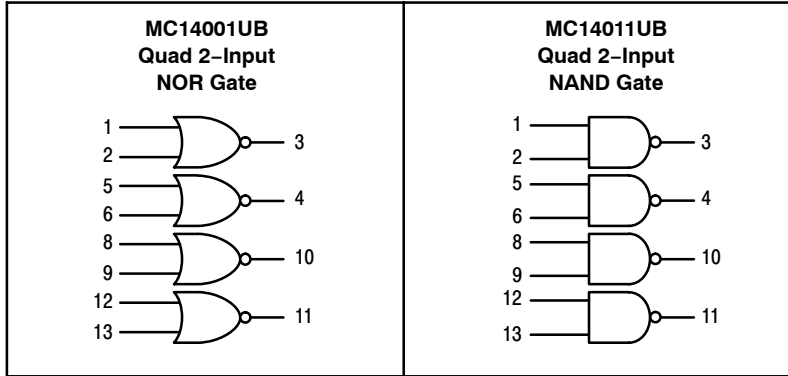

V_{DD} = PIN 14
 V_{SS} = PIN 7
 FOR ALL DEVICES

PIN ASSIGNMENTS

MC14001UB
Quad 2-Input NOR Gate

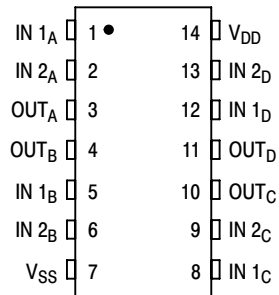

MC14011UB
Quad 2-Input NAND Gate

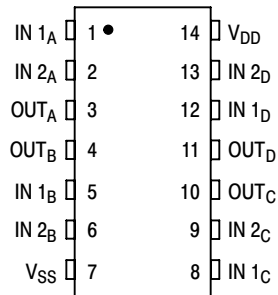

MC14001UB, MC14011UB

ELECTRICAL CHARACTERISTICS (Voltages Referenced to V_{SS})

Characteristic	Symbol	V _{DD} Vdc	- 55°C		25°C			125°C		Unit
			Min	Max	Min	Typ (Note 2)	Max	Min	Max	
Output Voltage V _{in} = V _{DD} or 0 V _{in} = 0 or V _{DD}	"0" Level V _{OL}	5.0	-	0.05	-	0	0.05	-	0.05	Vdc
		10	-	0.05	-	0	0.05	-	0.05	
		15	-	0.05	-	0	0.05	-	0.05	
	"1" Level V _{OH}	5.0	4.95	-	4.95	5.0	-	4.95	-	Vdc
		10	9.95	-	9.95	10	-	9.95	-	
		15	14.95	-	14.95	15	-	14.95	-	
Input Voltage (V _O = 4.5 Vdc) (V _O = 9.0 Vdc) (V _O = 13.5 Vdc) (V _O = 0.5 Vdc) (V _O = 1.0 Vdc) (V _O = 1.5 Vdc)	"0" Level V _{IL}	5.0	-	1.0	-	2.25	1.0	-	1.0	Vdc
		10	-	2.0	-	4.50	2.0	-	2.0	
		15	-	2.5	-	6.75	2.5	-	2.5	
	"1" Level I _{IH}	5.0	4.0	-	4.0	2.75	-	4.0	-	Vdc
		10	8.0	-	8.0	5.50	-	8.0	-	
		15	12.5	-	12.5	8.25	-	12.5	-	
Output Drive Current (V _{OH} = 2.5 Vdc) (V _{OH} = 4.6 Vdc) (V _{OH} = 9.5 Vdc) (V _{OH} = 13.5 Vdc) (V _{OL} = 0.4 Vdc) (V _{OL} = 0.5 Vdc) (V _{OL} = 1.5 Vdc)	Source I _{OH}	5.0	-1.2	-	-1.0	-1.7	-	-0.7	-	mAdc
		5.0	-0.25	-	-0.2	-0.36	-	-0.14	-	
		10	-0.62	-	-0.5	-0.9	-	-0.35	-	
	Sink I _{OL}	5.0	0.64	-	0.51	0.88	-	0.36	-	mAdc
		10	1.6	-	1.3	2.25	-	0.9	-	
		15	4.2	-	3.4	8.8	-	2.4	-	
Input Current	I _{in}	15	-	± 0.1	-	± 0.00001	± 0.1	-	± 1.0	μAdc
Input Capacitance (V _{in} = 0)	C _{in}	-	-	-	-	5.0	7.5	-	-	pF
Quiescent Current (Per Package)	I _{DD}	5.0	-	0.25	-	0.0005	0.25	-	7.5	μAdc
		10	-	0.5	-	0.0010	0.5	-	15	
		15	-	1.0	-	0.0015	1.0	-	30	
Total Supply Current (Notes 3, 4) (Dynamic plus Quiescent, Per Gate C _L = 50 pF)	I _T	5.0	I _T = (0.3 μA/kHz) f + I _{DD} /N							μAdc
10	I _T = (0.6 μA/kHz) f + I _{DD} /N									
15	I _T = (0.8 μA/kHz) f + I _{DD} /N									

2. Data labelled "Typ" is not to be used for design purposes but is intended as an indication of the IC's potential performance.

3. The formulas given are for the typical characteristics only at 25°C.

4. To calculate total supply current at loads other than 50 pF:

$$I_T(C_L) = I_T(50 \text{ pF}) + (C_L - 50) \text{ Vfk}$$

where: I_T is in μH (per package), C_L in pF, V = (V_{DD} - V_{SS}) in volts, f in kHz is input frequency, and k = 0.001 x the number of exercised gates per package.

SWITCHING CHARACTERISTICS (Note 5) (C_L = 50 pF, T_A = 25°C)

Characteristic	Symbol	V _{DD} Vdc	Min	Typ (Note 6)	Max	Unit
Output Rise Time t _{TLH} = (3.0 ns/pF) C _L + 30 ns t _{TLH} = (1.5 ns/pF) C _L + 15 ns t _{TLH} = (1.1 ns/pF) C _L + 10 ns	t _{TLH}	5.0	-	180	360	ns
		10	-	90	180	
		15	-	65	130	
Output Fall Time t _{THL} = (1.5 ns/pF) C _L + 25 ns t _{THL} = (0.75 ns/pF) C _L + 12.5 ns t _{THL} = (0.55 ns/pF) C _L + 9.5 ns	t _{THL}	5.0	-	100	200	ns
		10	-	50	100	
		15	-	40	80	
Propagation Delay Time t _{PLH} , t _{PHL} = (1.7 ns/pF) C _L + 30 ns t _{PLH} , t _{PHL} = (0.66 ns/pF) C _L + 22 ns t _{PLH} , t _{PHL} = (0.50 ns/pF) C _L + 15 ns	t _{PLH} , t _{PHL}	5.0	-	90	180	ns
		10	-	50	100	
		15	-	40	80	

5. The formulas given are for the typical characteristics only at 25°C.

6. Data labelled "Typ" is not to be used for design purposes but is intended as an indication of the IC's potential performance.

MC14001UB, MC14011UB

ORDERING INFORMATION

Device	Package	Shipping†
MC14001UBCP	PDIP-14	25 Units / Rail
MC14001UBCPG	PDIP-14 (Pb-Free)	
MC14001UBD	SOIC-14	55 Units / Rail
MC14001UBDG	SOIC-14 (Pb-Free)	
MC14001UBDR2	SOIC-14	2500 / Tape & Reel
MC14001UBDR2G	SOIC-14 (Pb-Free)	
MC14011UBCP	PDIP-14	25 Units / Rail
MC14011UBCPG	PDIP-14 (Pb-Free)	
MC14011UBD	SOIC-14	55 Units / Rail
MC14011UBDG	SOIC-14 (Pb-Free)	
MC14011UBDR2	SOIC-14	2500 / Tape & Reel
MC14011UBDR2G	SOIC-14 (Pb-Free)	

†For information on tape and reel specifications, including part orientation and tape sizes, please refer to our Tape and Reel Packaging Specifications Brochure, BRD8011/D.

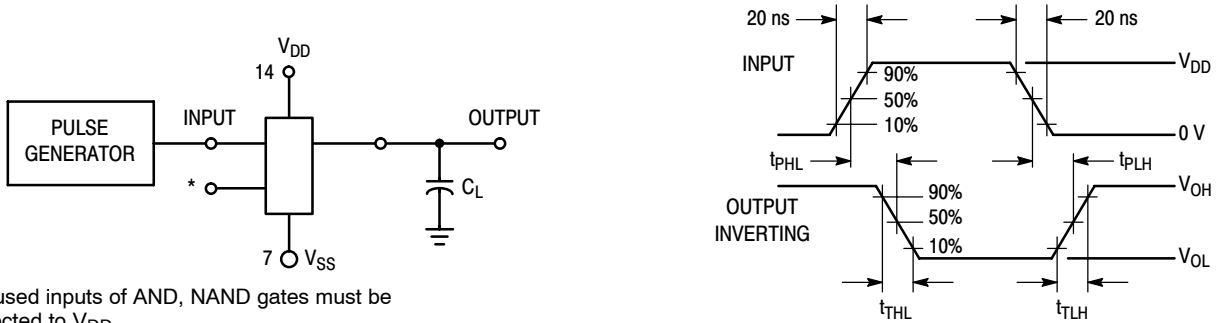

*All unused inputs of AND, NAND gates must be connected to V_{DD} .
All unused inputs of OR, NOR gates must be connected to V_{SS} .

Figure 1. Switching Time Test Circuit and Waveforms

MC14001UB, MC14011UB

MC14001UB CIRCUIT SCHEMATIC

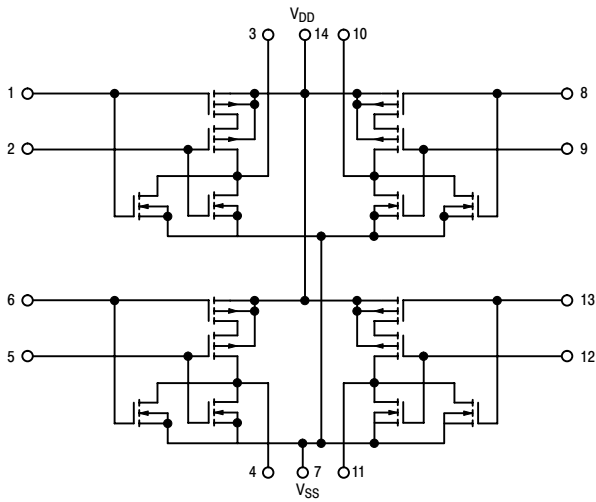

**MC14011UB CIRCUIT SCHEMATIC
(1/4 of Device Shown)**

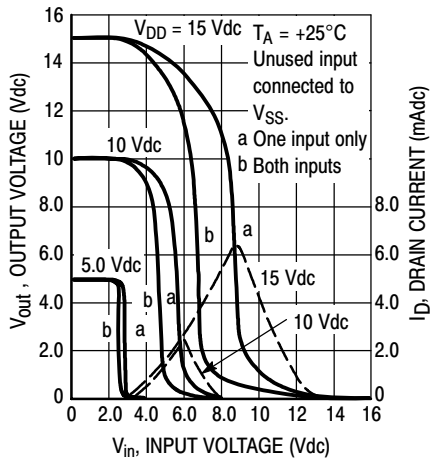
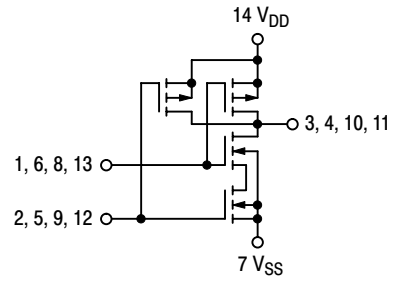

Figure 2. Typical Voltage and Current Transfer Characteristics

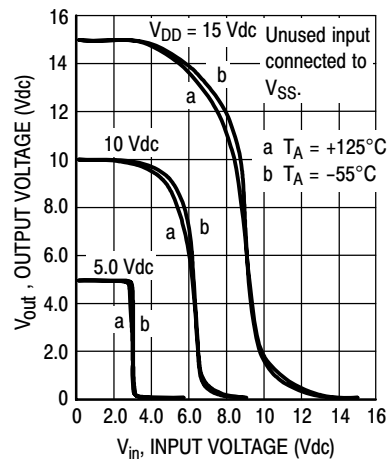

Figure 3. Typical Voltage Transfer Characteristics versus Temperature

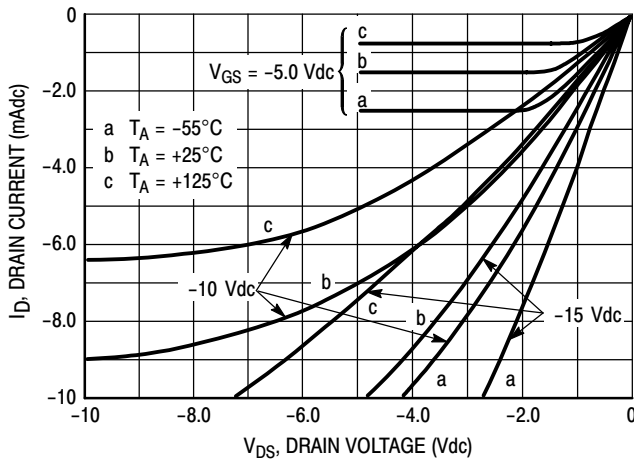

Figure 4. Typical Output Source Characteristics

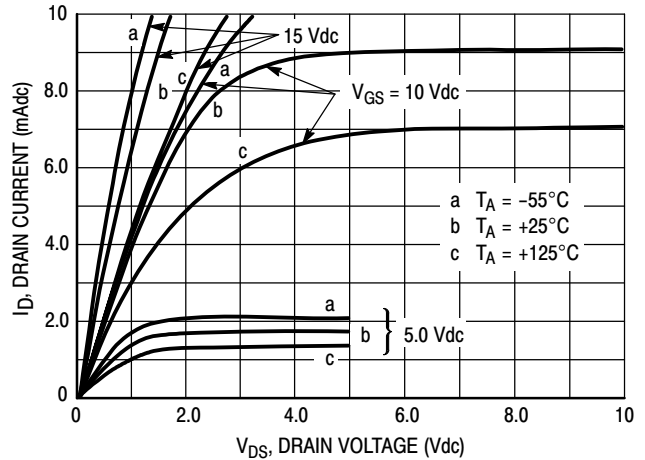
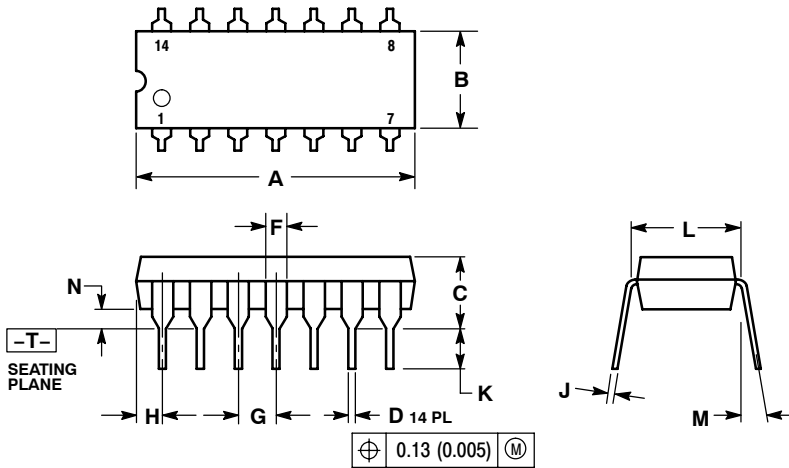

Figure 5. Typical Output Sink Characteristics

MC14001UB, MC14011UB

PACKAGE DIMENSIONS

PDIP-14
CASE 646-06
ISSUE P



NOTES:

1. DIMENSIONING AND TOLERANCING PER ANSI Y14.5M, 1982.
2. CONTROLLING DIMENSION: INCH.
3. DIMENSION L TO CENTER OF LEADS WHEN FORMED PARALLEL.
4. DIMENSION B DOES NOT INCLUDE MOLD FLASH.
5. ROUNDED CORNERS OPTIONAL.

DIM	INCHES		MILLIMETERS	
	MIN	MAX	MIN	MAX
A	0.715	0.770	18.16	19.56
B	0.240	0.260	6.10	6.60
C	0.145	0.185	3.69	4.69
D	0.015	0.021	0.38	0.53
F	0.040	0.070	1.02	1.78
G	0.100 BSC		2.54 BSC	
H	0.052	0.095	1.32	2.41
J	0.008	0.015	0.20	0.38
K	0.115	0.135	2.92	3.43
L	0.290	0.310	7.37	7.87
M	---	10°	---	10°
N	0.015	0.039	0.38	1.01

MC14001UB, MC14011UB

PACKAGE DIMENSIONS

SOIC-14
CASE 751A-03
ISSUE H

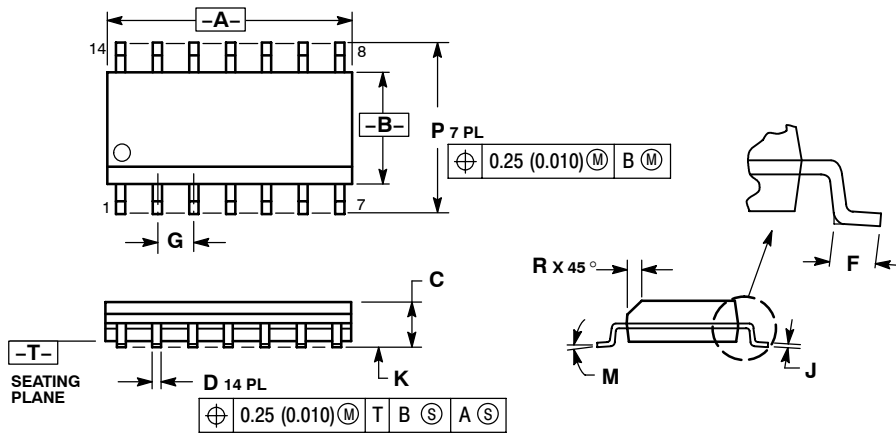

NOTES:

1. DIMENSIONING AND TOLERANCING PER ANSI Y14.5M, 1982.
2. CONTROLLING DIMENSION: MILLIMETER.
3. DIMENSIONS A AND B DO NOT INCLUDE MOLD PROTRUSION.
4. MAXIMUM MOLD PROTRUSION 0.15 (0.006) PER SIDE.
5. DIMENSION D DOES NOT INCLUDE DAMBAR PROTRUSION. ALLOWABLE DAMBAR PROTRUSION SHALL BE 0.127 (0.005) TOTAL IN EXCESS OF THE D DIMENSION AT MAXIMUM MATERIAL CONDITION.

DIM	MILLIMETERS		INCHES	
	MIN	MAX	MIN	MAX
A	8.55	8.75	0.337	0.344
B	3.80	4.00	0.150	0.157
C	1.35	1.75	0.054	0.068
D	0.35	0.49	0.014	0.019
F	0.40	1.25	0.016	0.049
G	1.27 BSC		0.050 BSC	
J	0.19	0.25	0.008	0.009
K	0.10	0.25	0.004	0.009
M	0°	7°	0°	7°
P	5.80	6.20	0.228	0.244
R	0.25	0.50	0.010	0.019

SOLDERING FOOTPRINT*

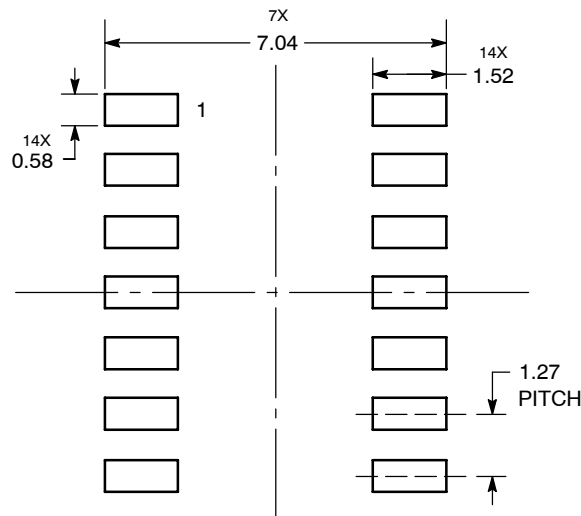

DIMENSIONS: MILLIMETERS

*For additional information on our Pb-Free strategy and soldering details, please download the ON Semiconductor Soldering and Mounting Techniques Reference Manual, SOLDERRM/D.

ON Semiconductor and are registered trademarks of Semiconductor Components Industries, LLC (SCILLC). SCILLC reserves the right to make changes without further notice to any products herein. SCILLC makes no warranty, representation or guarantee regarding the suitability of its products for any particular purpose, nor does SCILLC assume any liability arising out of the application or use of any product or circuit, and specifically disclaims any and all liability, including without limitation special, consequential or incidental damages. "Typical" parameters which may be provided in SCILLC data sheets and/or specifications can and do vary in different applications and actual performance may vary over time. All operating parameters, including "Typicals" must be validated for each customer application by customer's technical experts. SCILLC does not convey any license under its patent rights nor the rights of others. SCILLC products are not designed, intended, or authorized for use as components in systems intended for surgical implant into the body, or other applications intended to support or sustain life, or for any other application in which the failure of the SCILLC product could create a situation where personal injury or death may occur. Should Buyer purchase or use SCILLC products for any such unintended or unauthorized application, Buyer shall indemnify and hold SCILLC and its officers, employees, subsidiaries, affiliates, and distributors harmless against all claims, costs, damages, and expenses, and reasonable attorney fees arising out of, directly or indirectly, any claim of personal injury or death associated with such unintended or unauthorized use, even if such claim alleges that SCILLC was negligent regarding the design or manufacture of the part. SCILLC is an Equal Opportunity/Affirmative Action Employer. This literature is subject to all applicable copyright laws and is not for resale in any manner.

PUBLICATION ORDERING INFORMATION

LITERATURE FULFILLMENT:
Literature Distribution Center for ON Semiconductor
P.O. Box 5163, Denver, Colorado 80217 USA
Phone: 303-675-2175 or 800-344-3860 Toll Free USA/Canada
Fax: 303-675-2176 or 800-344-3867 Toll Free USA/Canada
Email: orderlit@onsemi.com

N. American Technical Support: 800-282-9855 Toll Free
USA/Canada
Europe, Middle East and Africa Technical Support:
Phone: 421 33 790 2910
Japan Customer Focus Center
Phone: 81-3-5773-3850

ON Semiconductor Website: www.onsemi.com
Order Literature: <http://www.onsemi.com/orderlit>

For additional information, please contact your local Sales Representative