

MC78L00, A Series

Three-Terminal Low Current Positive Voltage Regulators

The MC78L00, A Series of positive voltage regulators are inexpensive, easy-to-use devices suitable for a multitude of applications that require a regulated supply of up to 100 mA. Like their higher powered MC7800 and MC78M00 Series cousins, these regulators feature internal current limiting and thermal shutdown making them remarkably rugged. No external components are required with the MC78L00 devices in many applications.

These devices offer a substantial performance advantage over the traditional zener diode-resistor combination, as output impedance and quiescent current are substantially reduced.

- Wide Range of Available, Fixed Output Voltages
- Low Cost
- Internal Short Circuit Current Limiting
- Internal Thermal Overload Protection
- No External Components Required
- Complementary Negative Regulators Offered (MC79L00 Series)
- Available in either $\pm 5\%$ (AC) or $\pm 10\%$ (C) Selections

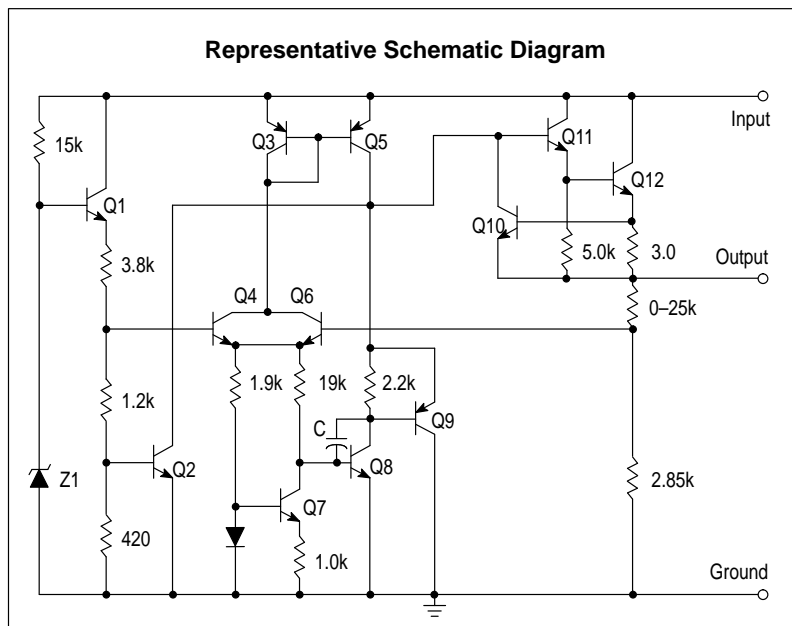

ORDERING INFORMATION

| Device | Operating Temperature Range | Package |
|-------------|--|---------------|
| MC78LXXACD* | $T_J = 0^\circ \text{ to } +125^\circ\text{C}$ | SOP-8 |
| MC78LXXACP | | Plastic Power |
| MC78LXXCPC | | Plastic Power |
| MC78LXXABD* | $T_J = -40^\circ \text{ to } +125^\circ\text{C}$ | SOP-8 |
| MC78LXXABP* | | Plastic Power |

XX indicates nominal voltage

*Available in 5, 8, 9, 12 and 15 V devices.

P SUFFIX CASE 29

- Pin 1. Output
2. GND
3. Input

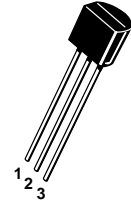

D SUFFIX PLASTIC PACKAGE CASE 751 (SOP-8)*



- Pin 1. V_{out} 5. NC
2. GND 6. GND
3. GND 7. GND
4. NC 8. V_{in}

*SOP-8 is an internally modified SO-8 package. Pins 2, 3, 6, and 7 are electrically common to the die attach flag. This internal lead frame modification decreases package thermal resistance and increases power dissipation capability when appropriately mounted on a printed circuit board. SOP-8 conforms to all external dimensions of the standard SO-8 package.

Standard Application

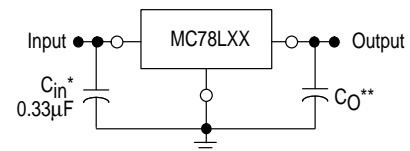

A common ground is required between the input and the output voltages. The input voltage must remain typically 2.0 V above the output voltage even during the low point on the input ripple voltage.

* C_{in} is required if regulator is located an appreciable distance from power supply filter.

** C_o is not needed for stability; however, it does improve transient response.

DEVICE TYPE/NOMINAL VOLTAGE

| 10% | 5% | Voltage |
|----------|-----------|---------|
| MC78L05C | MC78L05AC | 5.0 |
| MC78L08C | MC78L08AC | 8.0 |
| MC78L09C | MC78L09AC | 9.0 |
| MC78L12C | MC78L12AC | 12 |
| MC78L15C | MC78L15AC | 15 |
| MC78L18C | MC78L18AC | 18 |
| MC78L24C | MC78L24AC | 24 |

MC78L00, A Series

MAXIMUM RATINGS (T_A = +125°C, unless otherwise noted.)

| Rating | Symbol | Value | Unit |
|--|------------------|----------------|------|
| Input Voltage (2.6 V–8.0 V) (12 V–18 V) (24 V) | V _I | 30 35 40 | Vdc |
| Storage Temperature Range | T _{stg} | –65 to +150 | °C |
| Operating Junction Temperature Range | T _J | 0 to +150 | °C |

ELECTRICAL CHARACTERISTICS (V_I = 10 V, I_O = 40 mA, C_I = 0.33 μF, C_O = 0.1 μF, –40°C < T_J < +125°C (for MC78LXXAB), 0°C < T_J < +125°C (for MC78LXXAC), unless otherwise noted.)

| Characteristics | Symbol | MC78L05AC, AB | | | MC78L05C | | | Unit |
|--|---------------------------------|---------------|-----------|--------------|------------|-----------|------------|------|
| | | Min | Typ | Max | Min | Typ | Max | |
| Output Voltage (T _J = +25°C) | V _O | 4.8 | 5.0 | 5.2 | 4.6 | 5.0 | 5.4 | Vdc |
| Line Regulation (T _J = +25°C, I _O = 40 mA) 7.0 Vdc ≤ V _I ≤ 20 Vdc 8.0 Vdc ≤ V _I ≤ 20 Vdc | Reg _{line} | – | 55 45 | 150 100 | – | 55 45 | 200 150 | mV |
| Load Regulation (T _J = +25°C, 1.0 mA ≤ I _O ≤ 100 mA) (T _J = +25°C, 1.0 mA ≤ I _O ≤ 40 mA) | Reg _{load} | – | 11 5.0 | 60 30 | – | 11 5.0 | 60 30 | mV |
| Output Voltage (7.0 Vdc ≤ V _I ≤ 20 Vdc, 1.0 mA ≤ I _O ≤ 40 mA) (V _I = 10 V, 1.0 mA ≤ I _O ≤ 70 mA) | V _O | 4.75 4.75 | – | 5.25 5.25 | 4.5 4.5 | – | 5.5 5.5 | Vdc |
| Input Bias Current (T _J = +25°C) (T _J = +125°C) | I _{IB} | – | 3.8 – | 6.0 5.5 | – | 3.8 – | 6.0 5.5 | mA |
| Input Bias Current Change (8.0 Vdc ≤ V _I ≤ 20 Vdc) (1.0 mA ≤ I _O ≤ 40 mA) | ΔI _{IB} | – | – | 1.5 0.1 | – | – | 1.5 0.2 | mA |
| Output Noise Voltage (T _A = +25°C, 10 Hz ≤ f ≤ 100 kHz) | V _n | – | 40 | – | – | 40 | – | μV |
| Ripple Rejection (I _O = 40 mA, f = 120 Hz, 8.0 Vdc ≤ V _I ≤ 18 V, T _J = +25°C) | RR | 41 | 49 | – | 40 | 49 | – | dB |
| Dropout Voltage (T _J = +25°C) | V _I – V _O | – | 1.7 | – | – | 1.7 | – | Vdc |

ELECTRICAL CHARACTERISTICS (V_I = 14 V, I_O = 40 mA, C_I = 0.33 μF, C_O = 0.1 μF, –40°C < T_J < +125°C (for MC78LXXAB), 0°C < T_J < +125°C (for MC78LXXAC), unless otherwise noted.)

| Characteristics | Symbol | MC78L08AC, AB | | | MC78L08C | | | Unit |
|---|---------------------------------|---------------|-----------|------------|------------|-----------|------------|------|
| | | Min | Typ | Max | Min | Typ | Max | |
| Output Voltage (T _J = +25°C) | V _O | 7.7 | 8.0 | 8.3 | 7.36 | 8.0 | 8.64 | Vdc |
| Line Regulation (T _J = +25°C, I _O = 40 mA) 10.5 Vdc ≤ V _I ≤ 23 Vdc 11 Vdc ≤ V _I ≤ 23 Vdc | Reg _{line} | – | 20 12 | 175 125 | – | 20 12 | 200 150 | mV |
| Load Regulation (T _J = +25°C, 1.0 mA ≤ I _O ≤ 100 mA) (T _J = +25°C, 1.0 mA ≤ I _O ≤ 40 mA) | Reg _{load} | – | 15 8.0 | 80 40 | – | 15 6.0 | 80 40 | mV |
| Output Voltage (10.5 Vdc ≤ V _I ≤ 23 Vdc, 1.0 mA ≤ I _O ≤ 40 mA) (V _I = 14 V, 1.0 mA ≤ I _O ≤ 70 mA) | V _O | 7.6 7.6 | – | 8.4 8.4 | 7.2 7.2 | – | 8.8 8.8 | Vdc |
| Input Bias Current (T _J = +25°C) (T _J = +125°C) | I _{IB} | – | 3.0 – | 6.0 5.5 | – | 3.0 – | 6.0 5.5 | mA |
| Input Bias Current Change (11 Vdc ≤ V _I ≤ 23 Vdc) (1.0 mA ≤ I _O ≤ 40 mA) | ΔI _{IB} | – | – | 1.5 0.1 | – | – | 1.5 0.2 | mA |
| Output Noise Voltage (T _A = +25°C, 10 Hz ≤ f ≤ 100 kHz) | V _n | – | 60 | – | – | 52 | – | μV |
| Ripple Rejection (I _O = 40 mA, f = 120 Hz, 12 V ≤ V _I ≤ 23 V, T _J = +25°C) | RR | 37 | 57 | – | 36 | 55 | – | dB |
| Dropout Voltage (T _J = +25°C) | V _I – V _O | – | 1.7 | – | – | 1.7 | – | Vdc |

MC78L00, A Series

ELECTRICAL CHARACTERISTICS ($V_I = 15\text{ V}$, $I_O = 40\text{ mA}$, $C_I = 0.33\text{ }\mu\text{F}$, $C_O = 0.1\text{ }\mu\text{F}$, $-40^\circ\text{C} < T_J < +125^\circ\text{C}$ (for MC78LXXAB), $0^\circ\text{C} < T_J < +125^\circ\text{C}$ (for MC78LXXAC), unless otherwise noted.)

| Characteristics | Symbol | MC78L09AC, AB | | | MC78L09C | | | Unit |
|--|---------------------|---------------|-----|-----|----------|-----|-----|---------------|
| | | Min | Typ | Max | Min | Typ | Max | |
| Output Voltage ($T_J = +25^\circ\text{C}$) | V_O | 8.6 | 9.0 | 9.4 | 8.3 | 9.0 | 9.7 | Vdc |
| Line Regulation ($T_J = +25^\circ\text{C}$, $I_O = 40\text{ mA}$) $11.5\text{ Vdc} \leq V_I \leq 24\text{ Vdc}$ $12\text{ Vdc} \leq V_I \leq 24\text{ Vdc}$ | Reg _{line} | – | 20 | 175 | – | 20 | 200 | mV |
| Load Regulation ($T_J = +25^\circ\text{C}$, $1.0\text{ mA} \leq I_O \leq 100\text{ mA}$) ($T_J = +25^\circ\text{C}$, $1.0\text{ mA} \leq I_O \leq 40\text{ mA}$) | Reg _{load} | – | 15 | 90 | – | 15 | 90 | mV |
| Output Voltage ($11.5\text{ Vdc} \leq V_I \leq 24\text{ Vdc}$, $1.0\text{ mA} \leq I_O \leq 40\text{ mA}$) ($V_I = 15\text{ V}$, $1.0\text{ mA} \leq I_O \leq 70\text{ mA}$) | V_O | 8.5 | – | 9.5 | 8.1 | – | 9.9 | Vdc |
| Input Bias Current ($T_J = +25^\circ\text{C}$) ($T_J = +125^\circ\text{C}$) | I_{IB} | – | 3.0 | 6.0 | – | 3.0 | 6.0 | mA |
| Input Bias Current Change ($11\text{ Vdc} \leq V_I \leq 23\text{ Vdc}$) ($1.0\text{ mA} \leq I_O \leq 40\text{ mA}$) | ΔI_{IB} | – | – | 1.5 | – | – | 1.5 | mA |
| Output Noise Voltage ($T_A = +25^\circ\text{C}$, $10\text{ Hz} \leq f \leq 100\text{ kHz}$) | V_n | – | 60 | – | – | 52 | – | μV |
| Ripple Rejection ($I_O = 40\text{ mA}$, $f = 120\text{ Hz}$, $13\text{ V} \leq V_I \leq 24\text{ V}$, $T_J = +25^\circ\text{C}$) | RR | 37 | 57 | – | 36 | 55 | – | dB |
| Dropout Voltage ($T_J = +25^\circ\text{C}$) | $V_I - V_O$ | – | 1.7 | – | – | 1.7 | – | Vdc |

ELECTRICAL CHARACTERISTICS ($V_I = 19\text{ V}$, $I_O = 40\text{ mA}$, $C_I = 0.33\text{ }\mu\text{F}$, $C_O = 0.1\text{ }\mu\text{F}$, $-40^\circ\text{C} < T_J < +125^\circ\text{C}$ (for MC78LXXAB), $0^\circ\text{C} < T_J < +125^\circ\text{C}$ (for MC78LXXAC), unless otherwise noted.)

| Characteristics | Symbol | MC78L12AC, AB | | | MC78L12C | | | Unit |
|--|---------------------|---------------|-----|------|----------|-----|------|---------------|
| | | Min | Typ | Max | Min | Typ | Max | |
| Output Voltage ($T_J = +25^\circ\text{C}$) | V_O | 11.5 | 12 | 12.5 | 11.1 | 12 | 12.9 | Vdc |
| Line Regulation ($T_J = +25^\circ\text{C}$, $I_O = 40\text{ mA}$) $14.5\text{ Vdc} \leq V_I \leq 27\text{ Vdc}$ $16\text{ Vdc} \leq V_I \leq 27\text{ Vdc}$ | Reg _{line} | – | 120 | 250 | – | 120 | 250 | mV |
| Load Regulation ($T_J = +25^\circ\text{C}$, $1.0\text{ mA} \leq I_O \leq 100\text{ mA}$) ($T_J = +25^\circ\text{C}$, $1.0\text{ mA} \leq I_O \leq 40\text{ mA}$) | Reg _{load} | – | 20 | 100 | – | 20 | 100 | mV |
| Output Voltage ($14.5\text{ Vdc} \leq V_I \leq 27\text{ Vdc}$, $1.0\text{ mA} \leq I_O \leq 40\text{ mA}$) ($V_I = 19\text{ V}$, $1.0\text{ mA} \leq I_O \leq 70\text{ mA}$) | V_O | 11.4 | – | 12.6 | 10.8 | – | 13.2 | Vdc |
| Input Bias Current ($T_J = +25^\circ\text{C}$) ($T_J = +125^\circ\text{C}$) | I_{IB} | – | 4.2 | 6.5 | – | 4.2 | 6.5 | mA |
| Input Bias Current Change ($16\text{ Vdc} \leq V_I \leq 27\text{ Vdc}$) ($1.0\text{ mA} \leq I_O \leq 40\text{ mA}$) | ΔI_{IB} | – | – | 1.5 | – | – | 1.5 | mA |
| Output Noise Voltage ($T_A = +25^\circ\text{C}$, $10\text{ Hz} \leq f \leq 100\text{ kHz}$) | V_n | – | 80 | – | – | 80 | – | μV |
| Ripple Rejection ($I_O = 40\text{ mA}$, $f = 120\text{ Hz}$, $15\text{ V} \leq V_I \leq 25\text{ V}$, $T_J = +25^\circ\text{C}$) | RR | 37 | 42 | – | 36 | 42 | – | dB |
| Dropout Voltage ($T_J = +25^\circ\text{C}$) | $V_I - V_O$ | – | 1.7 | – | – | 1.7 | – | Vdc |

MC78L00, A Series

ELECTRICAL CHARACTERISTICS ($V_I = 23\text{ V}$, $I_O = 40\text{ mA}$, $C_I = 0.33\text{ }\mu\text{F}$, $C_O = 0.1\text{ }\mu\text{F}$, $-40^\circ\text{C} < T_J < +125^\circ\text{C}$ (for MC78LXXAB), $0^\circ\text{C} < T_J < +125^\circ\text{C}$ (for MC78LXXAC), unless otherwise noted.)

| Characteristics | Symbol | MC78L15AC, AB | | | MC78L15C | | | Unit |
|--|-----------------|---------------|-----|-------|----------|-----|------|---------------|
| | | Min | Typ | Max | Min | Typ | Max | |
| Output Voltage ($T_J = +25^\circ\text{C}$) | V_O | 14.4 | 15 | 15.6 | 13.8 | 15 | 16.2 | Vdc |
| Line Regulation ($T_J = +25^\circ\text{C}$, $I_O = 40\text{ mA}$) $17.5\text{ Vdc} \leq V_I \leq 30\text{ Vdc}$ $20\text{ Vdc} \leq V_I \leq 30\text{ Vdc}$ | Regline | – | 130 | 300 | – | 130 | 300 | mV |
| Load Regulation ($T_J = +25^\circ\text{C}$, $1.0\text{ mA} \leq I_O \leq 100\text{ mA}$) ($T_J = +25^\circ\text{C}$, $1.0\text{ mA} \leq I_O \leq 40\text{ mA}$) | Regload | – | 25 | 150 | – | 25 | 150 | mV |
| Output Voltage ($17.5\text{ Vdc} \leq V_I \leq 30\text{ Vdc}$, $1.0\text{ mA} \leq I_O \leq 40\text{ mA}$) ($V_I = 23\text{ V}$, $1.0\text{ mA} \leq I_O \leq 70\text{ mA}$) | V_O | 14.25 | – | 15.75 | 13.5 | – | 16.5 | Vdc |
| Input Bias Current ($T_J = +25^\circ\text{C}$) ($T_J = +125^\circ\text{C}$) | I_{IB} | – | 4.4 | 6.5 | – | 4.4 | 6.5 | mA |
| Input Bias Current Change ($20\text{ Vdc} \leq V_I \leq 30\text{ Vdc}$) ($1.0\text{ mA} \leq I_O \leq 40\text{ mA}$) | ΔI_{IB} | – | – | 1.5 | – | – | 1.5 | mA |
| Output Noise Voltage ($T_A = +25^\circ\text{C}$, $10\text{ Hz} \leq f \leq 100\text{ kHz}$) | V_n | – | 90 | – | – | 90 | – | μV |
| Ripple Rejection ($I_O = 40\text{ mA}$, $f = 120\text{ Hz}$, $18.5\text{ V} \leq V_I \leq 28.5\text{ V}$, $T_J = +25^\circ\text{C}$) | RR | 34 | 39 | – | 33 | 39 | – | dB |
| Dropout Voltage ($T_J = +25^\circ\text{C}$) | $V_I - V_O$ | – | 1.7 | – | – | 1.7 | – | Vdc |

ELECTRICAL CHARACTERISTICS ($V_I = 27\text{ V}$, $I_O = 40\text{ mA}$, $C_I = 0.33\text{ }\mu\text{F}$, $C_O = 0.1\text{ }\mu\text{F}$, $0^\circ\text{C} < T_J < +125^\circ\text{C}$, unless otherwise noted.)

| Characteristics | Symbol | MC78L18AC | | | MC78L18C | | | Unit |
|--|-----------------|-----------|-----|------|----------|-----|------|---------------|
| | | Min | Typ | Max | Min | Typ | Max | |
| Output Voltage ($T_J = +25^\circ\text{C}$) | V_O | 17.3 | 18 | 18.7 | 16.6 | 18 | 19.4 | Vdc |
| Line Regulation ($T_J = +25^\circ\text{C}$, $I_O = 40\text{ mA}$) $21.4\text{ Vdc} \leq V_I \leq 33\text{ Vdc}$ $20.7\text{ Vdc} \leq V_I \leq 33\text{ Vdc}$ $22\text{ Vdc} \leq V_I \leq 33\text{ Vdc}$ $21\text{ Vdc} \leq V_I \leq 33\text{ Vdc}$ | Regline | – | 45 | 325 | – | 32 | 325 | mV |
| Load Regulation ($T_J = +25^\circ\text{C}$, $1.0\text{ mA} \leq I_O \leq 100\text{ mA}$) ($T_J = +25^\circ\text{C}$, $1.0\text{ mA} \leq I_O \leq 40\text{ mA}$) | Regload | – | 30 | 170 | – | 30 | 170 | mV |
| Output Voltage ($21.4\text{ Vdc} \leq V_I \leq 33\text{ Vdc}$, $1.0\text{ mA} \leq I_O \leq 40\text{ mA}$) ($20.7\text{ Vdc} \leq V_I \leq 33\text{ Vdc}$, $1.0\text{ mA} \leq I_O \leq 40\text{ mA}$) ($V_I = 27\text{ V}$, $1.0\text{ mA} \leq I_O \leq 70\text{ mA}$) ($V_I = 27\text{ V}$, $1.0\text{ mA} \leq I_O \leq 70\text{ mA}$) | V_O | 17.1 | – | 18.9 | 16.2 | – | 19.8 | Vdc |
| Input Bias Current ($T_J = +25^\circ\text{C}$) ($T_J = +125^\circ\text{C}$) | I_{IB} | – | 3.1 | 6.5 | – | 3.1 | 6.5 | mA |
| Input Bias Current Change ($22\text{ Vdc} \leq V_I \leq 33\text{ Vdc}$) ($21\text{ Vdc} \leq V_I \leq 33\text{ Vdc}$) ($1.0\text{ mA} \leq I_O \leq 40\text{ mA}$) | ΔI_{IB} | – | – | 1.5 | – | – | 1.5 | mA |
| Output Noise Voltage ($T_A = +25^\circ\text{C}$, $10\text{ Hz} \leq f \leq 100\text{ kHz}$) | V_n | – | 150 | – | – | 150 | – | μV |
| Ripple Rejection ($I_O = 40\text{ mA}$, $f = 120\text{ Hz}$, $23\text{ V} \leq V_I \leq 33\text{ V}$, $T_J = +25^\circ\text{C}$) | RR | 33 | 48 | – | 32 | 46 | – | dB |
| Dropout Voltage ($T_J = +25^\circ\text{C}$) | $V_I - V_O$ | – | 1.7 | – | – | 1.7 | – | Vdc |

MC78L00, A Series

ELECTRICAL CHARACTERISTICS ($V_I = 33\text{ V}$, $I_O = 40\text{ mA}$, $C_I = 0.33\text{ }\mu\text{F}$, $C_O = 0.1\text{ }\mu\text{F}$, $0^\circ\text{C} < T_J < +125^\circ\text{C}$, unless otherwise noted.)

| Characteristics | Symbol | MC78L24AC | | | MC78L24C | | | Unit |
|---|---------------------|-----------|-----|------|----------|-----|------|---------------|
| | | Min | Typ | Max | Min | Typ | Max | |
| Output Voltage ($T_J = +25^\circ\text{C}$) | V_O | 23 | 24 | 25 | 22.1 | 24 | 25.9 | Vdc |
| Line Regulation ($T_J = +25^\circ\text{C}$, $I_O = 40\text{ mA}$) $27.5\text{ Vdc} \leq V_I \leq 38\text{ Vdc}$ $28\text{ Vdc} \leq V_I \leq 80\text{ Vdc}$ $27\text{ Vdc} \leq V_I \leq 38\text{ Vdc}$ | Reg _{line} | – | – | – | – | 35 | 350 | mV |
| Load Regulation ($T_J = +25^\circ\text{C}$, $1.0\text{ mA} \leq I_O \leq 100\text{ mA}$) ($T_J = +25^\circ\text{C}$, $1.0\text{ mA} \leq I_O \leq 40\text{ mA}$) | Reg _{load} | – | 40 | 200 | – | 40 | 200 | mV |
| Output Voltage ($28\text{ Vdc} \leq V_I \leq 38\text{ Vdc}$, $1.0\text{ mA} \leq I_O \leq 40\text{ mA}$) ($27\text{ Vdc} \leq V_I \leq 38\text{ Vdc}$, $1.0\text{ mA} \leq I_O \leq 40\text{ mA}$) ($28\text{ Vdc} \leq V_I = 33\text{ Vdc}$, $1.0\text{ mA} \leq I_O \leq 70\text{ mA}$) ($27\text{ Vdc} \leq V_I \leq 33\text{ Vdc}$, $1.0\text{ mA} \leq I_O \leq 70\text{ mA}$) | V_O | 22.8 | – | 25.2 | 21.6 | – | 26.4 | Vdc |
| Input Bias Current ($T_J = +25^\circ\text{C}$) ($T_J = +125^\circ\text{C}$) | I_{IB} | – | 3.1 | 6.5 | – | 3.1 | 6.5 | mA |
| Input Bias Current Change ($28\text{ Vdc} \leq V_I \leq 38\text{ Vdc}$) ($1.0\text{ mA} \leq I_O \leq 40\text{ mA}$) | ΔI_{IB} | – | – | 1.5 | – | – | 1.5 | mA |
| Output Noise Voltage ($T_A = +25^\circ\text{C}$, $10\text{ Hz} \leq f \leq 100\text{ kHz}$) | V_n | – | 200 | – | – | 200 | – | μV |
| Ripple Rejection ($I_O = 40\text{ mA}$, $f = 120\text{ Hz}$, $29\text{ V} \leq V_I \leq 35\text{ V}$, $T_J = +25^\circ\text{C}$) | RR | 31 | 45 | – | 30 | 43 | – | dB |
| Dropout Voltage ($T_J = +25^\circ\text{C}$) | $V_I - V_O$ | – | 1.7 | – | – | 1.7 | – | Vdc |

Figure 1. Dropout Characteristics

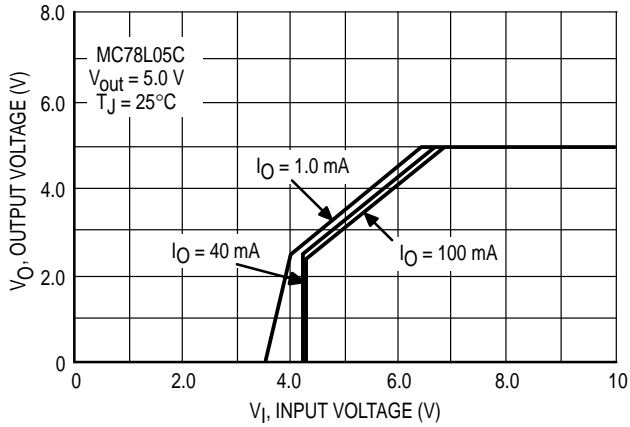

Figure 2. Dropout Voltage versus Junction Temperature

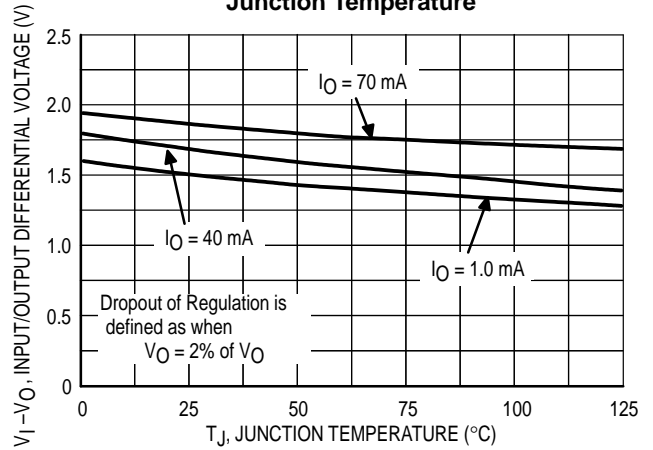

Figure 3. Input Bias Current versus Ambient Temperature

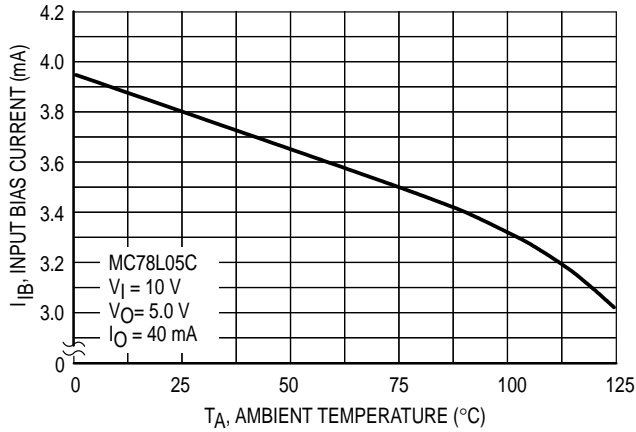

Figure 4. Input Bias Current versus Input Voltage

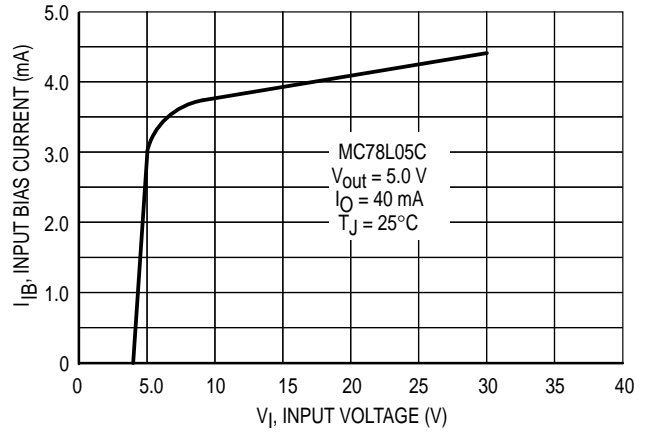

Figure 5. Maximum Average Power Dissipation versus Ambient Temperature – TO-92 Type Package

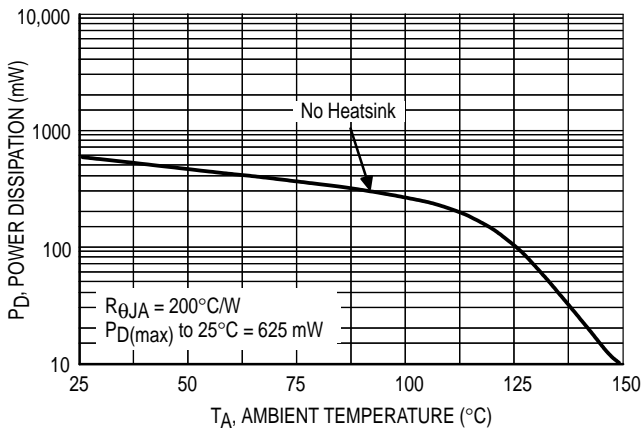
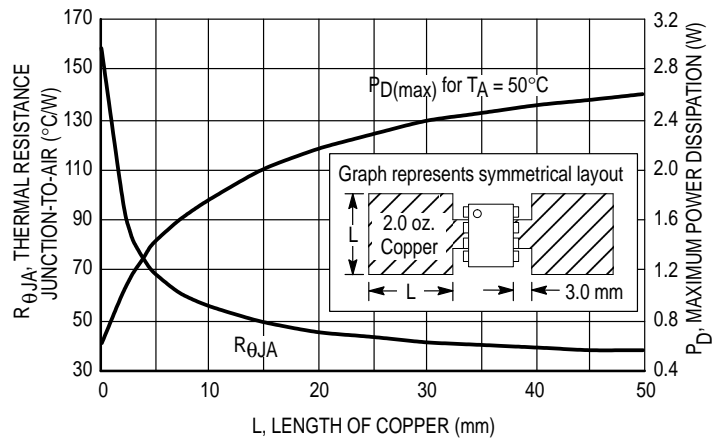

Figure 6. SOP-8 Thermal Resistance and Maximum Power Dissipation versus P.C.B. Copper Length



MC78L00, A Series

APPLICATIONS INFORMATION

Design Considerations

The MC78L00 Series of fixed voltage regulators are designed with Thermal Overload Protection that shuts down the circuit when subjected to an excessive power overload condition. Internal Short Circuit Protection limits the maximum current the circuit will pass.

In many low current applications, compensation capacitors are not required. However, it is recommended that the regulator input be bypassed with a capacitor if the regulator is connected to the power supply filter with long wire lengths, or if the output load capacitance is large. The input

bypass capacitor should be selected to provide good high-frequency characteristics to insure stable operation under all load conditions. A 0.33 μF or larger tantalum, mylar, or other capacitor having low internal impedance at high frequencies should be chosen. The bypass capacitor should be mounted with the shortest possible leads directly across the regulators input terminals. Good construction techniques should be used to minimize ground loops and lead resistance drops since the regulator has no external sense lead. Bypassing the output is also recommended.

Figure 7. Current Regulator

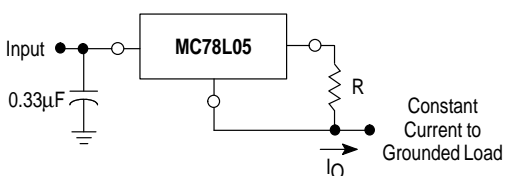

The MC78L00 regulators can also be used as a current source when connected as above. In order to minimize dissipation the MC78L05C is chosen in this application. Resistor R determines the current as follows:

$$I_O = \frac{5.0 \text{ V}}{R} + I_B$$

$I_B = 3.8 \text{ mA}$ over line and load changes

For example, a 100 mA current source would require R to be a 50 Ω, 1/2 W resistor and the output voltage compliance would be the input voltage less 7 V.

Figure 8. ± 15 V Tracking Voltage Regulator

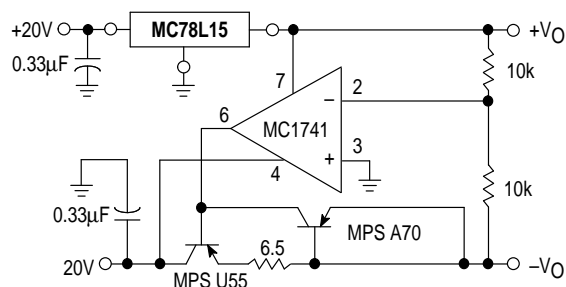
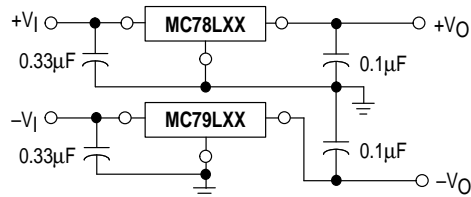

Figure 9. Positive and Negative Regulator



MC78L00, A Series

OUTLINE DIMENSIONS

P SUFFIX PLASTIC PACKAGE CASE 29-04 ISSUE AD

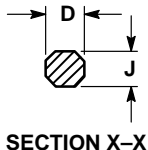
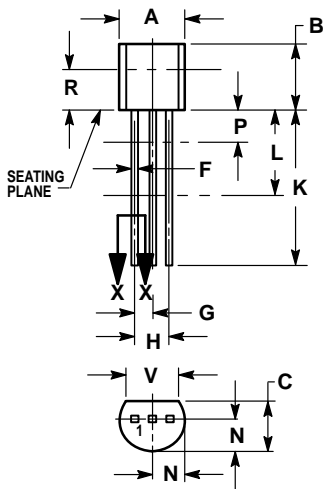

NOTES:

1. DIMENSIONING AND TOLERANCING PER ANSI Y14.5M, 1982.
2. CONTROLLING DIMENSION: INCH.
3. CONTOUR OF PACKAGE BEYOND DIMENSION R IS UNCONTROLLED.
4. DIMENSION F APPLIES BETWEEN P AND L. DIMENSION D AND J APPLY BETWEEN L AND K. MINIMUM LEAD DIMENSION IS UNCONTROLLED IN P AND BEYOND DIMENSION K MINIMUM.

| DIM | INCHES | | MILLIMETERS | |
|-----|--------|-------|-------------|------|
| | MIN | MAX | MIN | MAX |
| A | 0.175 | 0.205 | 4.45 | 5.20 |
| B | 0.170 | 0.210 | 4.32 | 5.33 |
| C | 0.125 | 0.165 | 3.18 | 4.19 |
| D | 0.016 | 0.022 | 0.41 | 0.55 |
| F | 0.016 | 0.019 | 0.41 | 0.48 |
| G | 0.045 | 0.055 | 1.15 | 1.39 |
| H | 0.095 | 0.105 | 2.42 | 2.66 |
| J | 0.015 | 0.020 | 0.39 | 0.50 |
| K | 0.500 | — | 12.70 | — |
| L | 0.250 | — | 6.35 | — |
| N | 0.080 | 0.105 | 2.04 | 2.66 |
| P | — | 0.100 | — | 2.54 |
| R | 0.115 | — | 2.93 | — |
| V | 0.135 | — | 3.43 | — |

D SUFFIX PLASTIC PACKAGE CASE 751-05 (SOP-8) ISSUE R

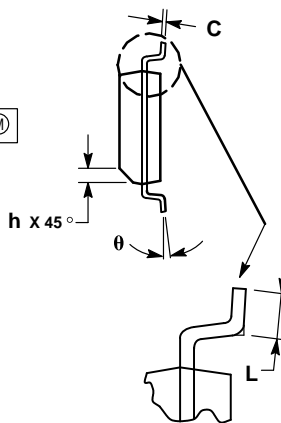
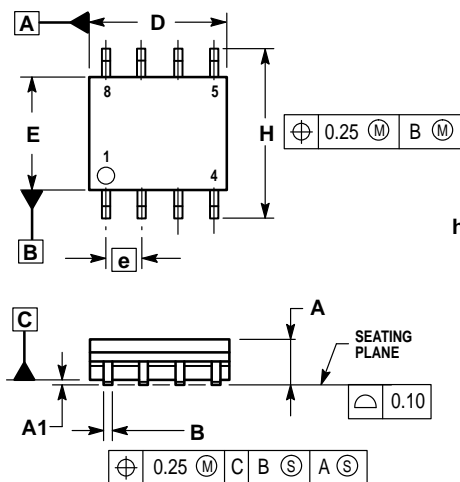

NOTES:

1. DIMENSIONING AND TOLERANCING PER ASME Y14.5M, 1994.
2. DIMENSIONS ARE IN MILLIMETERS.
3. DIMENSION D AND E DO NOT INCLUDE MOLD PROTRUSION.
4. MAXIMUM MOLD PROTRUSION 0.15 PER SIDE.
5. DIMENSION B DOES NOT INCLUDE MOLD PROTRUSION. ALLOWABLE DAMBAR PROTRUSION SHALL BE 0.127 TOTAL IN EXCESS OF THE B DIMENSION AT MAXIMUM MATERIAL CONDITION.

| DIM | MILLIMETERS | |
|----------|-------------|------|
| | MIN | MAX |
| A | 1.35 | 1.75 |
| A1 | 0.10 | 0.25 |
| B | 0.35 | 0.49 |
| C | 0.18 | 0.25 |
| D | 4.80 | 5.00 |
| E | 3.80 | 4.00 |
| e | 1.27 BSC | — |
| H | 5.80 | 6.20 |
| h | 0.25 | 0.50 |
| L | 0.40 | 1.25 |
| θ | 0° | 7° |

Motorola reserves the right to make changes without further notice to any products herein. Motorola makes no warranty, representation or guarantee regarding the suitability of its products for any particular purpose, nor does Motorola assume any liability arising out of the application or use of any product or circuit, and specifically disclaims any and all liability, including without limitation consequential or incidental damages. "Typical" parameters which may be provided in Motorola data sheets and/or specifications can and do vary in different applications and actual performance may vary over time. All operating parameters, including "Typicals" must be validated for each customer application by customer's technical experts. Motorola does not convey any license under its patent rights nor the rights of others. Motorola products are not designed, intended, or authorized for use as components in systems intended for surgical implant into the body, or other applications intended to support or sustain life, or for any other application in which the failure of the Motorola product could create a situation where personal injury or death may occur. Should Buyer purchase or use Motorola products for any such unintended or unauthorized application, Buyer shall indemnify and hold Motorola and its officers, employees, subsidiaries, affiliates, and distributors harmless against all claims, costs, damages, and expenses, and reasonable attorney fees arising out of, directly or indirectly, any claim of personal injury or death associated with such unintended or unauthorized use, even if such claim alleges that Motorola was negligent regarding the design or manufacture of the part. Motorola and registered trademarks of Motorola, Inc. Motorola, Inc. is an Equal Opportunity/Affirmative Action Employer.

How to reach us:

USA/EUROPE/Locations Not Listed: Motorola Literature Distribution;
P.O. Box 20912; Phoenix, Arizona 85036. 1-800-441-2447 or 602-303-5454

MFAX: RMFAX0@email.sps.mot.com - TOUCHTONE 602-244-6609

INTERNET: <http://Design-NET.com>

JAPAN: Nippon Motorola Ltd.; Tatsumi-SPD-JLDC, 6F Seibu-Butsuryu-Center,
3-14-2 Tatsumi Koto-Ku, Tokyo 135, Japan. 03-81-3521-8315

ASIA/PACIFIC: Motorola Semiconductors H.K. Ltd.; 8B Tai Ping Industrial Park,
51 Ting Kok Road, Tai Po, N.T., Hong Kong. 852-26629298



MC78L00/D

