

MCR100 Series

Preferred Device

Sensitive Gate Silicon Controlled Rectifiers

Reverse Blocking Thyristors

PNPN devices designed for high volume, line-powered consumer applications such as relay and lamp drivers, small motor controls, gate drivers for larger thyristors, and sensing and detection circuits. Supplied in an inexpensive plastic TO-226AA package which is readily adaptable for use in automatic insertion equipment.

Features

- Sensitive Gate Allows Triggering by Microcontrollers and Other Logic Circuits
- Blocking Voltage to 600 V
- On-State Current Rating of 0.8 A RMS at 80°C
- High Surge Current Capability – 10 A
- Minimum and Maximum Values of IGT, VGT and IH Specified for Ease of Design
- Immunity to dV/dt – 20 V/ μ sec Minimum at 110°C
- Glass-Passivated Surface for Reliability and Uniformity
- Pb-Free Packages are Available*



ON Semiconductor®

<http://onsemi.com>

SCRs
0.8 A RMS
100 thru 600 V

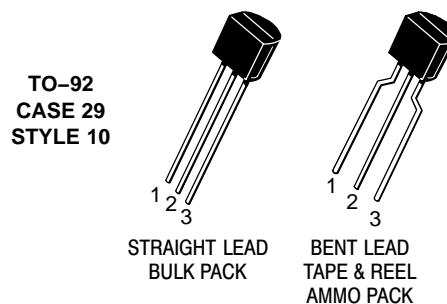

MARKING DIAGRAM

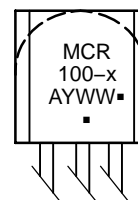

- x = Specific Device Code
- A = Assembly Location
- Y = Year
- WW = Work Week
- = Pb-Free Package

(Note: Microdot may be in either location)

PIN ASSIGNMENT

PIN ASSIGNMENT	
1	Cathode
2	Gate
3	Anode

ORDERING INFORMATION

See detailed ordering and shipping information on page 5 of this data sheet.

Preferred devices are recommended choices for future use and best overall value.

*For additional information on our Pb-Free strategy and soldering details, please download the ON Semiconductor Soldering and Mounting Techniques Reference Manual, SOLDERRM/D.

MCR100 Series

MAXIMUM RATINGS (T_J = 25°C unless otherwise noted)

Rating	Symbol	Value	Unit
Peak Repetitive Off-State Voltage (Notes 1 and 2) (T _J = -40 to 110°C, Sine Wave, 50 to 60 Hz; Gate Open)	V _{DRM} , V _{RPM}	100 200 400 600	V
On-State RMS Current, (T _C = 80°C) 180° Conduction Angles	I _{T(RMS)}	0.8	A
Peak Non-Repetitive Surge Current, (1/2 Cycle, Sine Wave, 60 Hz, T _J = 25°C)	I _{TSM}	10	A
Circuit Fusing Consideration, (t = 8.3 ms)	I ² t	0.415	A ² s
Forward Peak Gate Power, (T _A = 25°C, Pulse Width ≤ 1.0 μs)	P _{GM}	0.1	W
Forward Average Gate Power, (T _A = 25°C, t = 8.3 ms)	P _{G(AV)}	0.10	W
Forward Peak Gate Current, (T _A = 25°C, Pulse Width ≤ 1.0 μs)	I _{GM}	1.0	A
Reverse Peak Gate Voltage, (T _A = 25°C, Pulse Width ≤ 1.0 μs)	V _{GRM}	5.0	V
Operating Junction Temperature Range @ Rate V _{RPM} and V _{DRM}	T _J	-40 to 110	°C
Storage Temperature Range	T _{stg}	-40 to 150	°C

Stresses exceeding Maximum Ratings may damage the device. Maximum Ratings are stress ratings only. Functional operation above the Recommended Operating Conditions is not implied. Extended exposure to stresses above the Recommended Operating Conditions may affect device reliability.

- V_{DRM} and V_{RPM} for all types can be applied on a continuous basis. Ratings apply for zero or negative gate voltage; however, positive gate voltage shall not be applied concurrent with negative potential on the anode. Blocking voltages shall not be tested with a constant current source such that the voltage ratings of the devices are exceeded.
- See ordering information for exact device number options.

THERMAL CHARACTERISTICS

Characteristic	Symbol	Max	Unit
Thermal Resistance, Junction-to-Case Junction-to-Ambient	R _{θJC} R _{θJA}	75 200	°C/W
Lead Solder Temperature (< 1/16" from case, 10 secs max)	T _L	260	°C

ELECTRICAL CHARACTERISTICS (T_C = 25°C unless otherwise noted)

Characteristic	Symbol	Min	Typ	Max	Unit
----------------	--------	-----	-----	-----	------

OFF CHARACTERISTICS

Peak Repetitive Forward or Reverse Blocking Current (Note 2) (V _D = Rated V _{DRM} and V _{RPM} ; R _{GK} = 1 kΩ)	I _{DRM} , I _{RPM}	-	-	10 100	μA

ON CHARACTERISTICS

Peak Forward On-State Voltage* (I _{TM} = 1.0 A Peak @ T _A = 25°C)	V _{TM}	-	-	1.7	V
Gate Trigger Current (Continuous dc) (Note 3) (V _{AK} = 7.0 Vdc, R _L = 100 Ω)	I _{GT}	-	40	200	μA
Holding Current ⁽²⁾ (V _{AK} = 7.0 Vdc, Initiating Current = 20 mA)	I _H	-	0.5	5.0 10	mA
Latch Current (V _{AK} = 7.0 V, I _g = 200 μA)	I _L	-	0.6	10 15	mA
Gate Trigger Voltage (Continuous dc) (Note 3) (V _{AK} = 7.0 Vdc, R _L = 100 Ω)	V _{GT}	-	0.62	0.8 1.2	V

DYNAMIC CHARACTERISTICS

Critical Rate of Rise of Off-State Voltage (V _D = Rated V _{DRM} , Exponential Waveform, R _{GK} = 1000 Ω, T _J = 110°C)	dV/dt	20	35	-	V/μs
Critical Rate of Rise of On-State Current (I _{PK} = 20 A; P _w = 10 μsec; diG/dt = 1 A/μsec, I _{gt} = 20 mA)	di/dt	-	-	50	A/μs

*Indicates Pulse Test: Pulse Width ≤ 1.0 ms, Duty Cycle ≤ 1%.

3. R_{GK} = 1000 Ω included in measurement.

4. Does not include R_{GK} in measurement.

MCR100 Series

Voltage Current Characteristic of SCR

Symbol	Parameter
V_{DRM}	Peak Repetitive Off State Forward Voltage
I_{DRM}	Peak Forward Blocking Current
V_{RRM}	Peak Repetitive Off State Reverse Voltage
I_{RRM}	Peak Reverse Blocking Current
V_{TM}	Peak on State Voltage
I_H	Holding Current

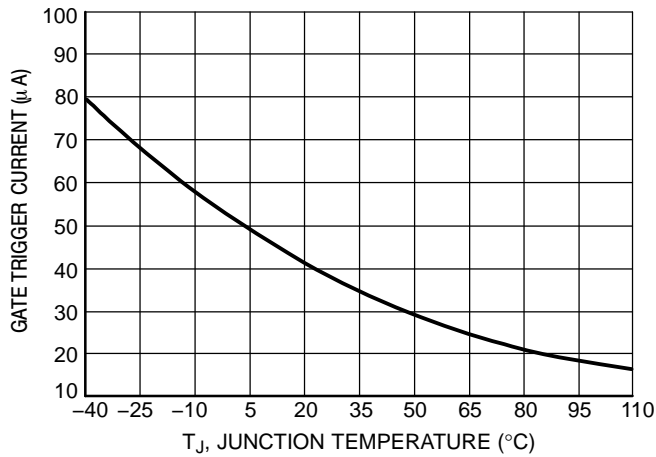
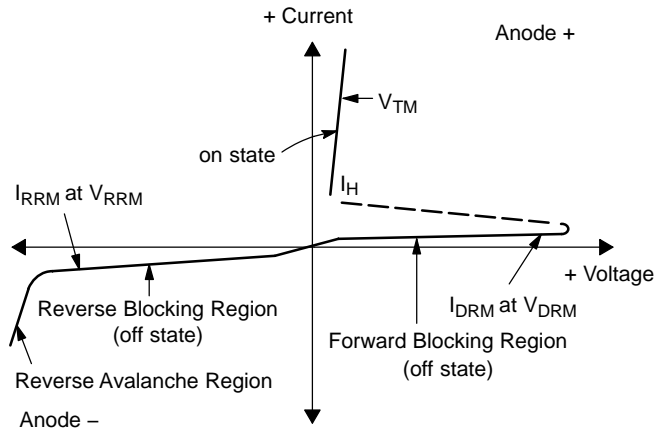

Figure 1. Typical Gate Trigger Current versus Junction Temperature

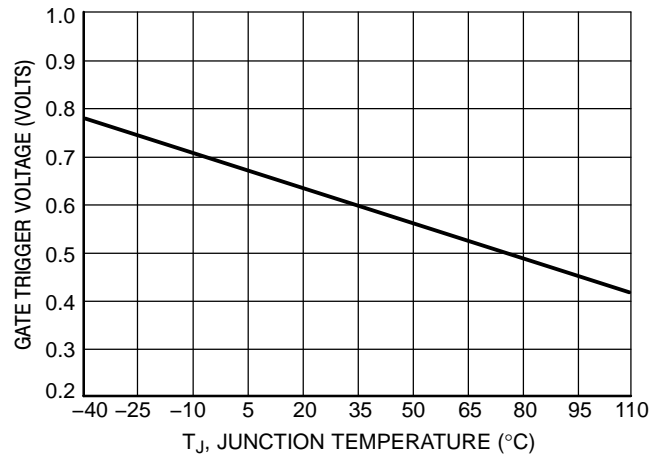

Figure 2. Typical Gate Trigger Voltage versus Junction Temperature

MCR100 Series

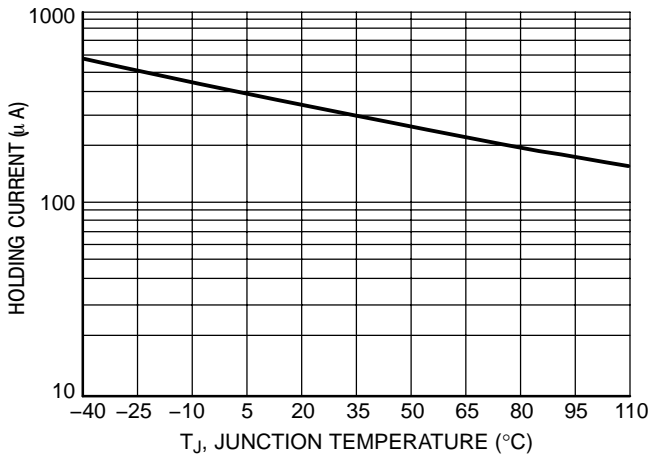

Figure 3. Typical Holding Current versus Junction Temperature

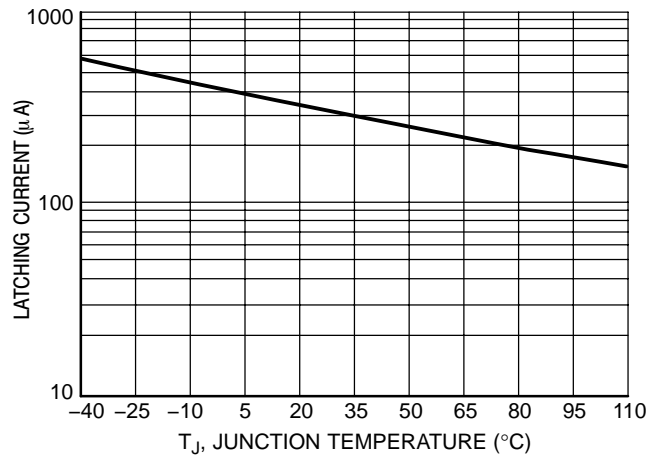

Figure 4. Typical Latching Current versus Junction Temperature

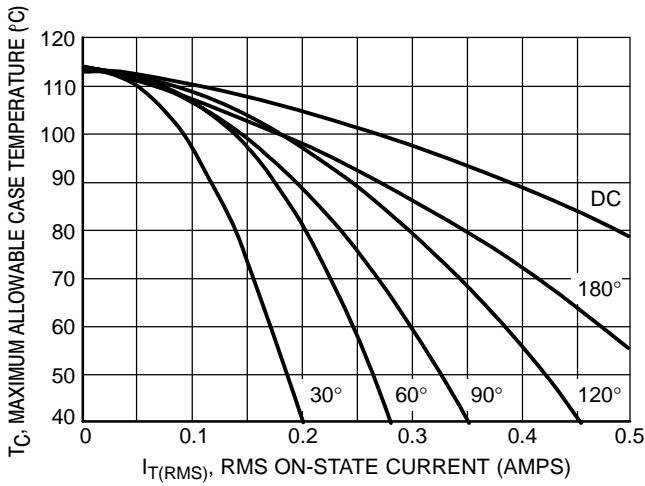

Figure 5. Typical RMS Current Derating

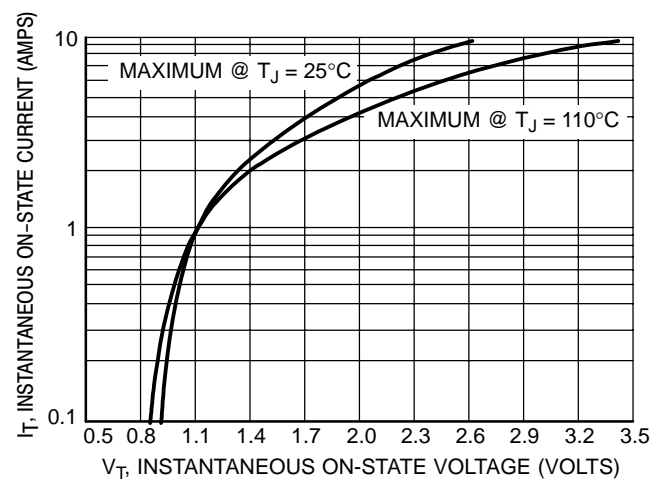

Figure 6. Typical On-State Characteristics

MCR100 Series

ORDERING INFORMATION

Device	Package Code	Shipping†
MCR100-003	TO-92 (TO-226)	5000 Units / Box
MCR100-004		
MCR100-006		
MCR100-008		
MCR100-3RL		2000 / Tape & Reel
MCR100-6RL		
MCR100-6RLRA		
MCR100-6RLRM		
MCR100-6ZL1		
MCR100-8RL		
MCR100-3G	TO-92 (TO-226) (Pb-Free)	5000 Units / Box
MCR100-4G		
MCR100-6G		
MCR100-8G		
MCR100-3RLG		2000 / Tape & Reel
MCR100-6RLG		
MCR100-6RLRAG		
MCR100-6RLRMG		
MCR100-6ZL1G		
MCR100-8RLG		
		2000 / Tape & Ammo Pack
		2000 / Tape & Reel

†For information on tape and reel specifications, including part orientation and tape sizes, please refer to our Tape and Reel Packaging Specifications Brochure, BRD8011/D.

MCR100 Series

TO-92 EIA RADIAL TAPE IN BOX OR ON REEL

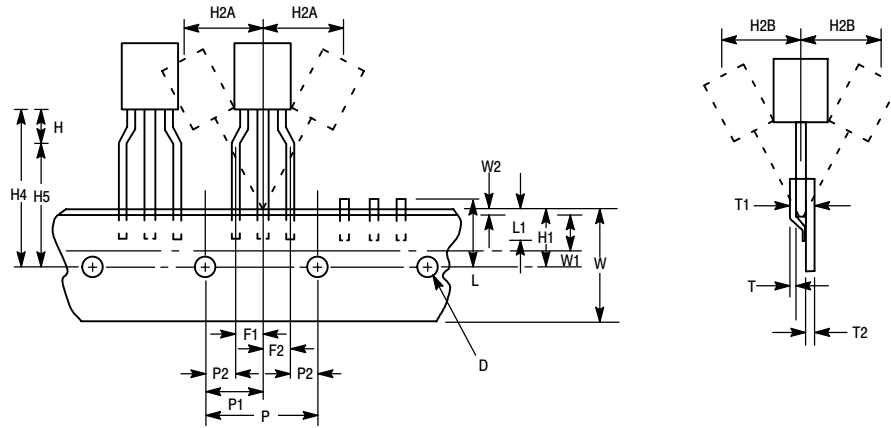

Figure 7. Device Positioning on Tape

Symbol	Item	Specification			
		Inches		Millimeter	
		Min	Max	Min	Max
D	Tape Feedhole Diameter	0.1496	0.1653	3.8	4.2
D2	Component Lead Thickness Dimension	0.015	0.020	0.38	0.51
F1, F2	Component Lead Pitch	0.0945	0.110	2.4	2.8
H	Bottom of Component to Seating Plane	.059	.156	1.5	4.0
H1	Feedhole Location	0.3346	0.3741	8.5	9.5
H2A	Deflection Left or Right	0	0.039	0	1.0
H2B	Deflection Front or Rear	0	0.051	0	1.0
H4	Feedhole to Bottom of Component	0.7086	0.768	18	19.5
H5	Feedhole to Seating Plane	0.610	0.649	15.5	16.5
L	Defective Unit Clipped Dimension	0.3346	0.433	8.5	11
L1	Lead Wire Enclosure	0.09842	—	2.5	—
P	Feedhole Pitch	0.4921	0.5079	12.5	12.9
P1	Feedhole Center to Center Lead	0.2342	0.2658	5.95	6.75
P2	First Lead Spacing Dimension	0.1397	0.1556	3.55	3.95
T	Adhesive Tape Thickness	0.06	0.08	0.15	0.20
T1	Overall Taped Package Thickness	—	0.0567	—	1.44
T2	Carrier Strip Thickness	0.014	0.027	0.35	0.65
W	Carrier Strip Width	0.6889	0.7481	17.5	19
W1	Adhesive Tape Width	0.2165	0.2841	5.5	6.3
W2	Adhesive Tape Position	.0059	0.01968	.15	0.5

NOTES:

1. Maximum alignment deviation between leads not to be greater than 0.2 mm.
2. Defective components shall be clipped from the carrier tape such that the remaining protrusion (L) does not exceed a maximum of 11 mm.
3. Component lead to tape adhesion must meet the pull test requirements.
4. Maximum non-cumulative variation between tape feed holes shall not exceed 1 mm in 20 pitches.
5. Hold down tape not to extend beyond the edge(s) of carrier tape and there shall be no exposure of adhesive.
6. No more than 1 consecutive missing component is permitted.
7. A tape trailer and leader, having at least three feed holes is required before the first and after the last component.
8. Splices will not interfere with the sprocket feed holes.

MCR100 Series

PACKAGE DIMENSIONS

TO-92 (TO-226) CASE 29-11 ISSUE AM

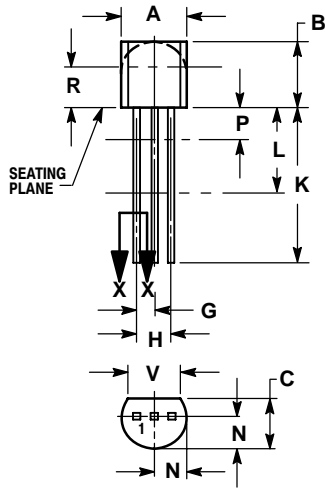

STRAIGHT LEAD
BULK PACK

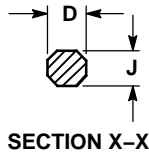

SECTION X-X

NOTES:

1. DIMENSIONING AND TOLERANCING PER ANSI Y14.5M, 1982.
2. CONTROLLING DIMENSION: INCH.
3. CONTOUR OF PACKAGE BEYOND DIMENSION R IS UNCONTROLLED.
4. LEAD DIMENSION IS UNCONTROLLED IN P AND BEYOND DIMENSION K MINIMUM.

DIM	INCHES		MILLIMETERS	
	MIN	MAX	MIN	MAX
A	0.175	0.205	4.45	5.20
B	0.170	0.210	4.32	5.33
C	0.125	0.165	3.18	4.19
D	0.016	0.021	0.407	0.533
G	0.045	0.055	1.15	1.39
H	0.095	0.105	2.42	2.66
J	0.015	0.020	0.39	0.50
K	0.500	---	12.70	---
L	0.250	---	6.35	---
N	0.080	0.105	2.04	2.66
P	---	0.100	---	2.54
R	0.115	---	2.93	---
V	0.135	---	3.43	---

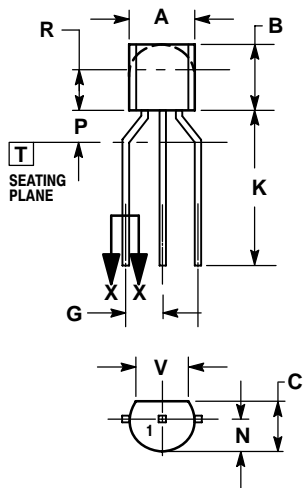

BENT LEAD
TAPE & REEL
AMMO PACK

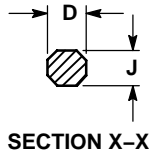

SECTION X-X

NOTES:

1. DIMENSIONING AND TOLERANCING PER ASME Y14.5M, 1994.
2. CONTROLLING DIMENSION: MILLIMETERS.
3. CONTOUR OF PACKAGE BEYOND DIMENSION R IS UNCONTROLLED.
4. LEAD DIMENSION IS UNCONTROLLED IN P AND BEYOND DIMENSION K MINIMUM.

DIM	MILLIMETERS	
	MIN	MAX
A	4.45	5.20
B	4.32	5.33
C	3.18	4.19
D	0.40	0.54
G	2.40	2.80
J	0.39	0.50
K	12.70	---
N	2.04	2.66
P	1.50	4.00
R	2.93	---
V	3.43	---

STYLE 10:

1. CATHODE
2. GATE
3. ANODE

ON Semiconductor and **ON** are registered trademarks of Semiconductor Components Industries, LLC (SCILLC). SCILLC reserves the right to make changes without further notice to any products herein. SCILLC makes no warranty, representation or guarantee regarding the suitability of its products for any particular purpose, nor does SCILLC assume any liability arising out of the application or use of any product or circuit, and specifically disclaims any and all liability, including without limitation special, consequential or incidental damages. "Typical" parameters which may be provided in SCILLC data sheets and/or specifications can and do vary in different applications and actual performance may vary over time. All operating parameters, including "Typicals" must be validated for each customer application by customer's technical experts. SCILLC does not convey any license under its patent rights nor the rights of others. SCILLC products are not designed, intended, or authorized for use as components in systems intended for surgical implant into the body, or other applications intended to support or sustain life, or for any other application in which the failure of the SCILLC product could create a situation where personal injury or death may occur. Should Buyer purchase or use SCILLC products for any such unintended or unauthorized application, Buyer shall indemnify and hold SCILLC and its officers, employees, subsidiaries, affiliates, and distributors harmless against all claims, costs, damages, and expenses, and reasonable attorney fees arising out of, directly or indirectly, any claim of personal injury or death associated with such unintended or unauthorized use, even if such claim alleges that SCILLC was negligent regarding the design or manufacture of the part. SCILLC is an Equal Opportunity/Affirmative Action Employer. This literature is subject to all applicable copyright laws and is not for resale in any manner.

PUBLICATION ORDERING INFORMATION

LITERATURE FULFILLMENT:
Literature Distribution Center for ON Semiconductor
P.O. Box 5163, Denver, Colorado 80217 USA
Phone: 303-675-2175 or 800-344-3860 Toll Free USA/Canada
Fax: 303-675-2176 or 800-344-3867 Toll Free USA/Canada
Email: orderlit@onsemi.com

N. American Technical Support: 800-282-9855 Toll Free
USA/Canada
Europe, Middle East and Africa Technical Support:
Phone: 421 33 790 2910
Japan Customer Focus Center
Phone: 81-3-5773-3850

ON Semiconductor Website: www.onsemi.com
Order Literature: <http://www.onsemi.com/orderlit>

For additional information, please contact your local Sales Representative