

Surface Mount

Dual Matched MMIC Amplifiers

NEW!

MERA-7456

50Ω High Dynamic Range DC to 1 GHz

Features

- Two matched amplifiers in one package
- InGaP HBT IF and RF amplifier
- frequency range, DC to 1 GHz, usable to 4 GHz
- high gain, 25.1 dB typ. at 100 MHz
- up to +19 dBm typ. output power at 100 MHz
- high IP3, +36 dBm at 100 MHz
- low noise figure, 2.7 dB typ.
- low thermal resistance
- transient protected
- patent pending
- useable as balanced and push pull amplifier

Applications

- cellular
- catv
- VHF & UHF communication receivers & transmitters

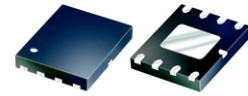

CASE STYLE: DL1020
PRICE: \$ 4.70 ea. QTY (25)

Electrical Specifications @ 25°C

Freq.* (GHz)	Gain, dB Typical A1, A2					Maximum Power (dBm)					Dynamic Range			VSWR (:1) Typ.		Maximum Rating**		DC Operating Power Pin 5, Pin 8			Thermal Resistance θjc, typ. °C/W		matching ¹							
																							Amplitude Unbalance between 2 amps (dB)		Phase Unbalance between 2 amps (deg.)					
	f _L -f _U	0.1	1	2	3	4	Min. @ 1GHz	Output (1 dB Comp.) Typ. 0.1 GHz	1.0 GHz	2.0 GHz	Min. @ 0.1GHz	Input (no dmg.) 0.1 GHz	NF (dB) Typ.	0.1 GHz	0.5 GHz	1.0 GHz	I mA	P mW	Current (mA)	Volt Typ	Min	Max	θjc, typ. °C/W	DC-1 GHz Typ.	0.3 GHz Max.	1-4 GHz Typ.	0.1 GHz Max.	1-4 GHz Typ.	0.6 GHz Max.	1.0 GHz Typ.
DC-1	25.1	22.5	18.6	14.2	9.4	20	19	18.2	14.4	18	10	2.7	36	35	32	1.3	2.0	130	700	80	4.8	4.3	5.3	120	0.1	0.3	0.1	—	0.6	1.0

* Guaranteed specification DC-1GHz. Low frequency cutoff determined by external coupling capacitors.

** Permanent damage may occur if any of these limits are exceeded.

These ratings are not intended for continuous normal operation. Reliability predictions and normal operating conditions are applicable at current specified.

1. For test method, see application note AN-60-032

Pin Connections

PORT	
RF IN 1	1
RF OUT 1	8
RF IN 2	4
RF OUT 2	5
DC 1	8
DC 2	5
GROUND	2,3,6,7 and paddle

MTTF vs. Junction Temperature

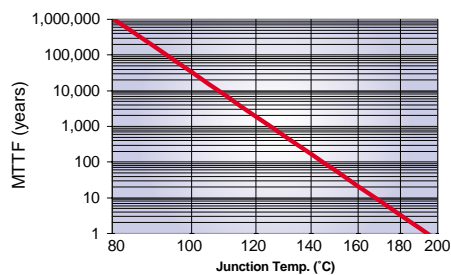

Maximum Ratings²

Operating Case Temperature -45°C to 85°C

Storage Temperature -55°C to 100°C

2. See application note AN-60-032 for adequate heat sinking of paddle.

typical biasing configuration

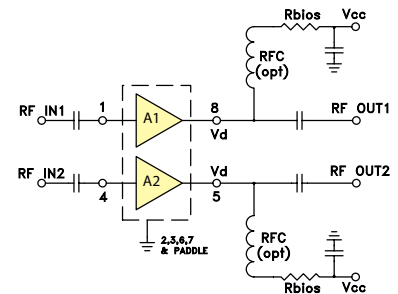

Outline Drawing

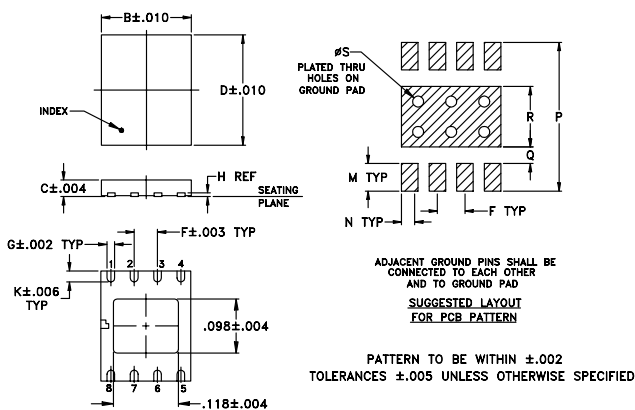

Outline Dimensions (inch)

A	B	C	D	E	F	G	H	J	K	L	M	N	P	Q	R	S	wt.
-.193	.035	.236	-.050	.017	.008	-.024	-.050	.030	.270	.030	.110	.020					grams
- 4.90	0.90	6.00	- 1.27	0.43	0.20	- 0.60	- 1.27	0.76	6.86	0.76	2.79	0.51					.08

Demo Board MCL P/N: TB-293 Suggested PCB Layout (PL-164)

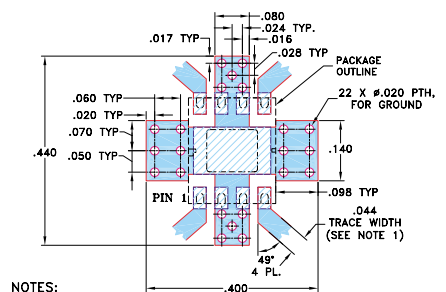

NOTES:

1. TRACE WIDTH IS SHOWN FOR ROGERS RO4350 WITH DIELECTRIC THICKNESS .020 ± .0015. COPPER: 1/2 OZ. EACH SIDE. FOR OTHER MATERIALS TRACE WIDTH MAY NEED TO BE MODIFIED.
2. BOTTOM SIDE OF THE PCB IS CONTINUOUS GROUND PLANE.

■ DENOTES PCB COPPER LAYOUT

■ DENOTES COPPER LAND PATTERN FREE OF SOLDER MASK



INTERNET <http://www.minicircuits.com>

P.O. Box 350166, Brooklyn, New York 11235-0003 (718) 934-4500 Fax (718) 332-4661

Distribution Centers NORTH AMERICA 800-654-7949 • 417-335-5935 • Fax 417-335-5945 • EUROPE 44-1252-832600 • Fax 44-1252-837010

Mini-Circuits ISO 9001 & ISO 14001 Certified

REV. OR
M94145
MERA-7456
ED-11699/8
WZ/TD/CP
040927

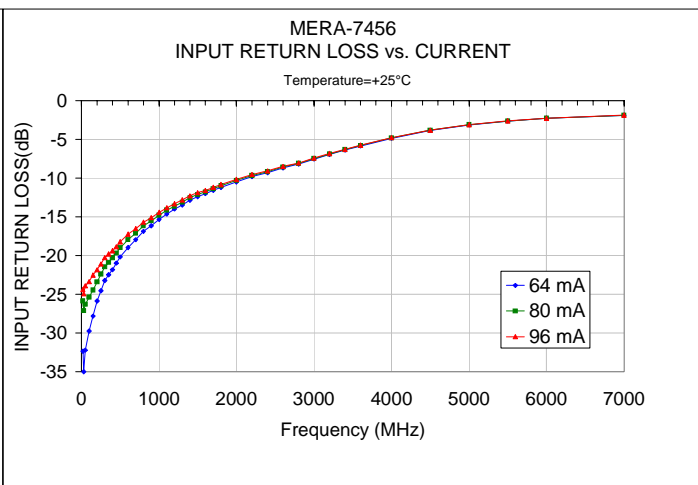
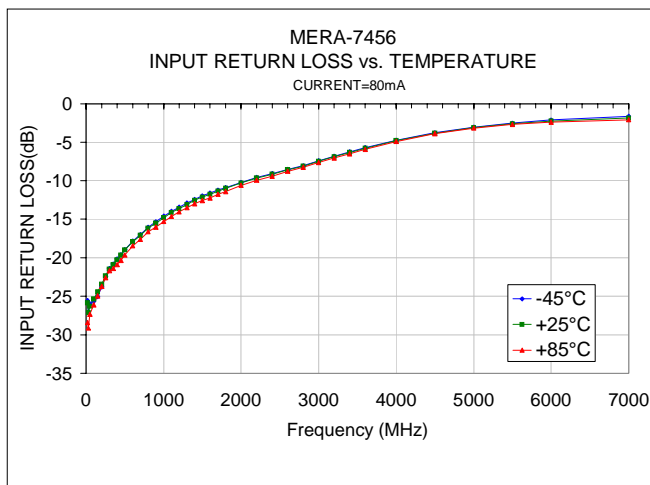
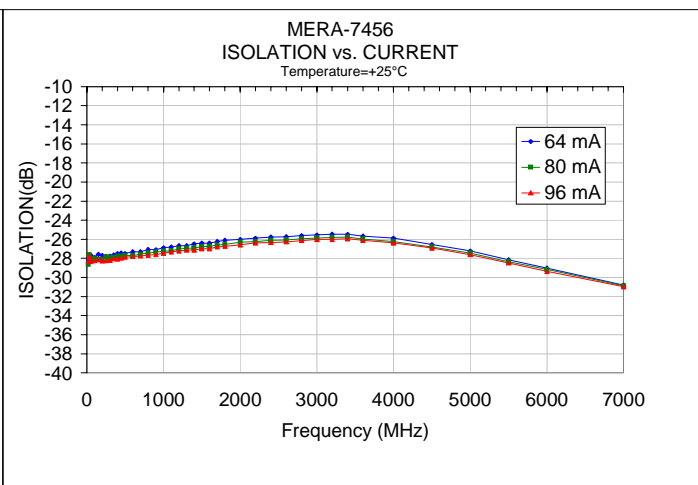
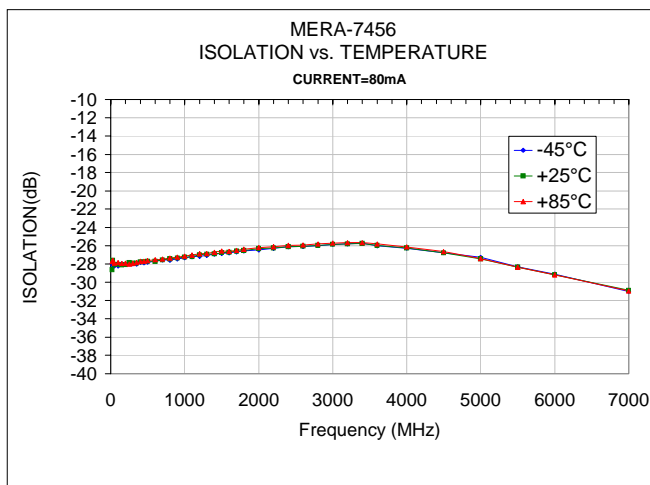
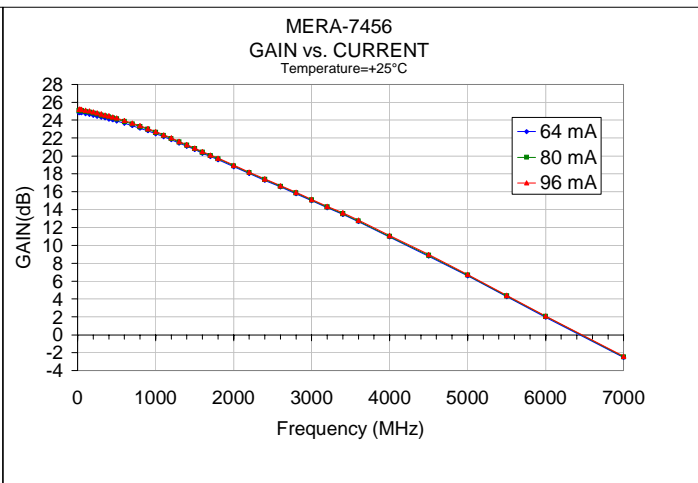
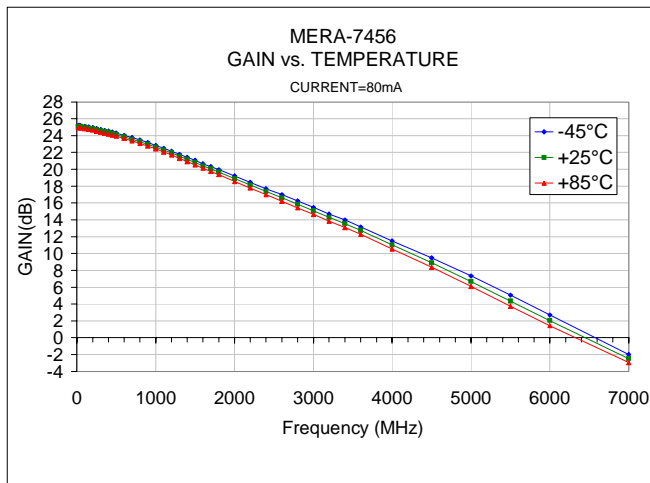

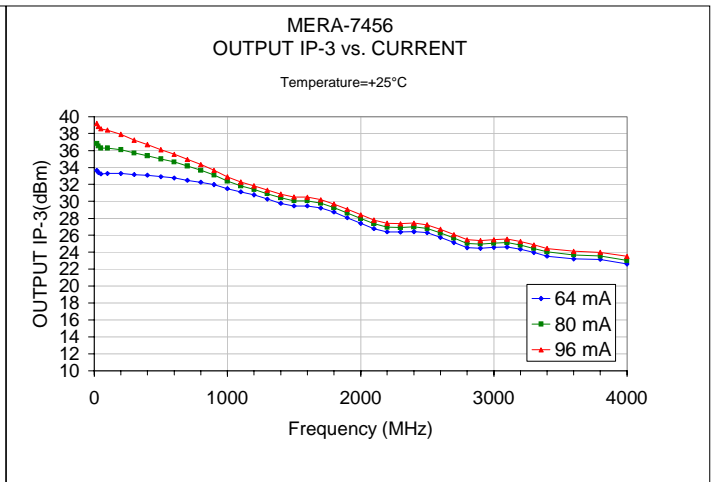
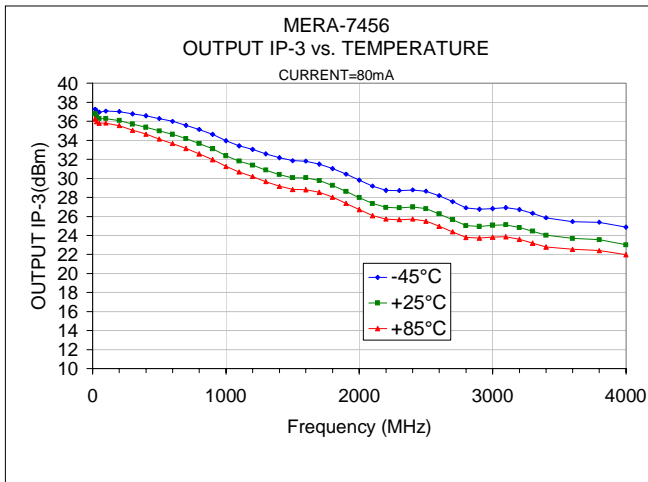
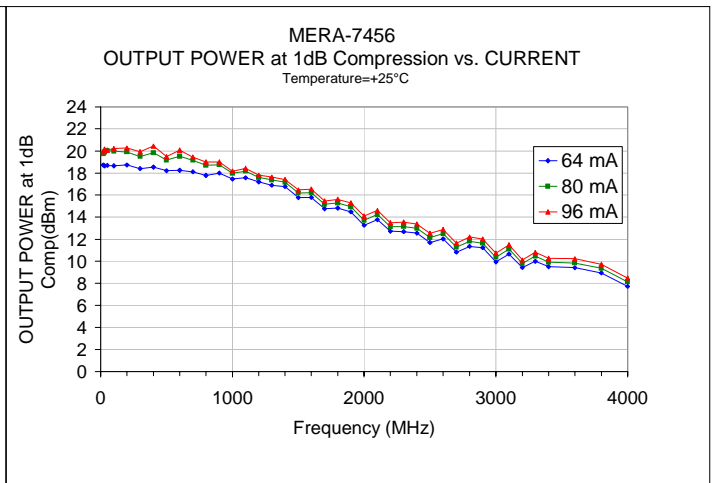
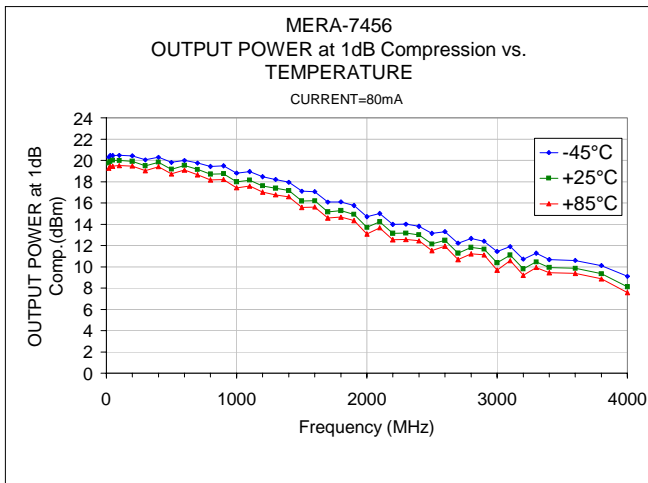
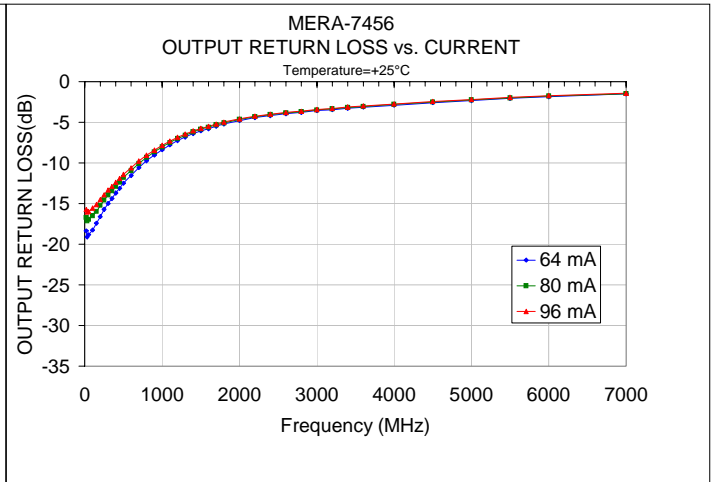
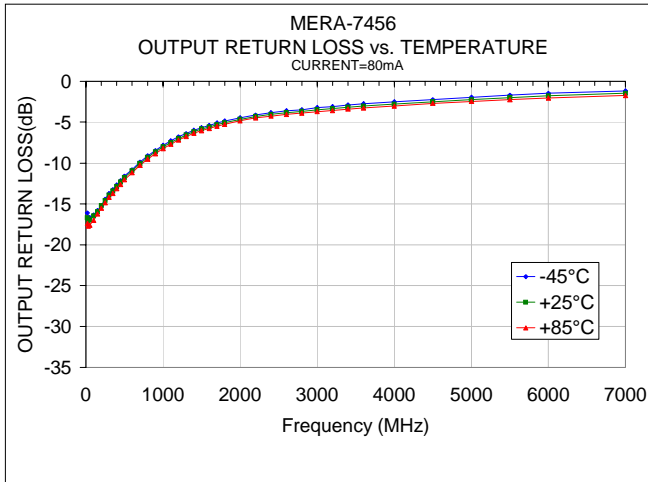

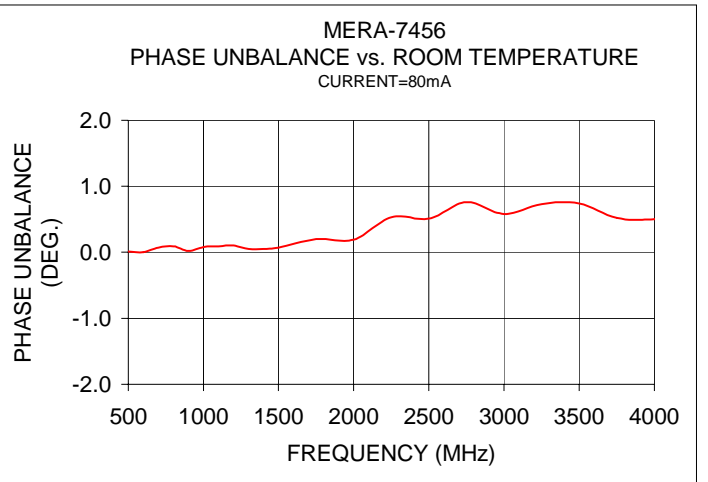
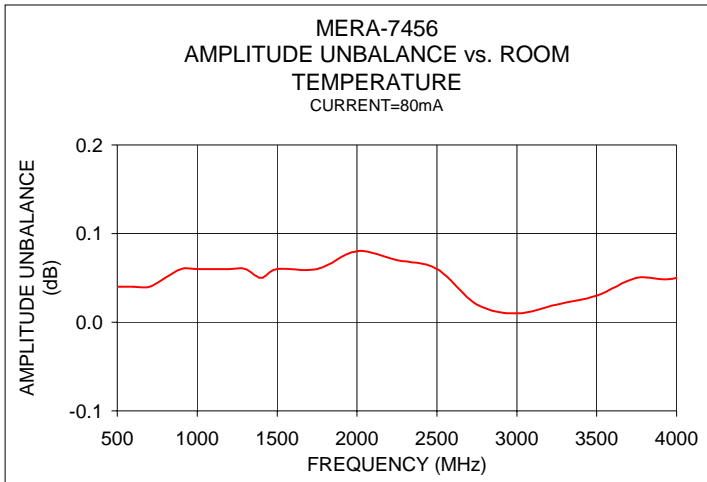
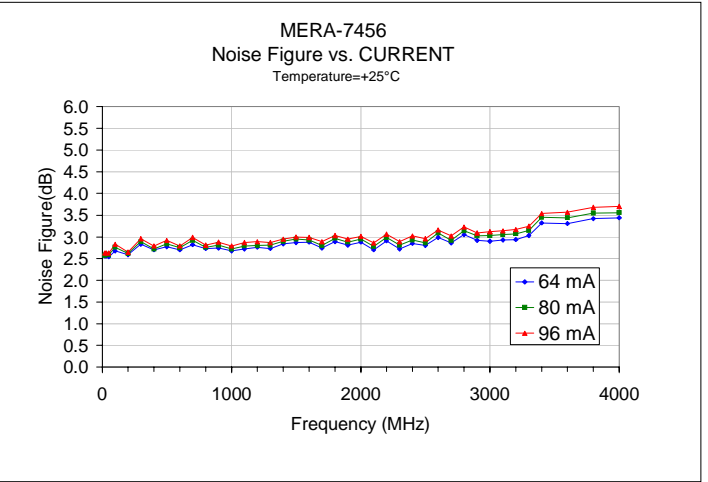
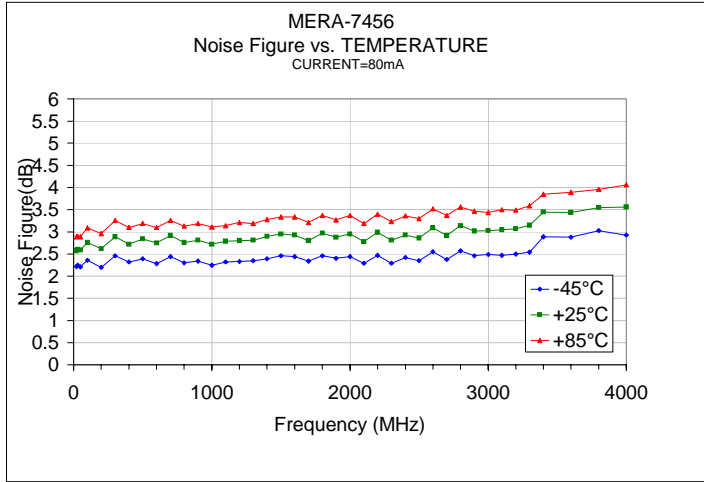

Freq. MHz	S11 (Input Return Loss)			S21 (Power Gain)			S12 (Isolation Out-in)			S22 (Output Return Loss)			K
	dB	Mag	Angle	dB	Mag	Angle	dB	Mag	Angle	dB	Mag	Angle	
20.00	-36.68	0.01	-152.95	24.91	17.60	175.49	-27.81	0.04	-2.57	-20.02	0.10	177.43	1.05
30.00	-38.06	0.01	-171.41	24.97	17.72	174.47	-27.68	0.04	-3.21	-19.27	0.11	-179.27	1.04
50.00	-35.29	0.02	-155.23	24.92	17.62	171.16	-27.87	0.04	-5.30	-19.58	0.10	-175.29	1.05
100.00	-32.12	0.02	-139.13	24.87	17.52	163.20	-27.85	0.04	-8.52	-18.70	0.12	-173.03	1.05
150.00	-30.48	0.03	-142.13	24.81	17.40	155.36	-27.71	0.04	-11.74	-17.89	0.13	-171.49	1.04
200.00	-27.36	0.04	-149.92	24.72	17.22	147.16	-27.81	0.04	-16.69	-16.84	0.14	-172.36	1.05
250.00	-25.79	0.05	-151.71	24.61	17.00	139.23	-27.92	0.04	-19.66	-15.81	0.16	-174.89	1.05
300.00	-23.89	0.06	-162.37	24.51	16.81	131.32	-27.63	0.04	-24.08	-15.09	0.18	-177.83	1.04
350.00	-23.36	0.07	-169.13	24.42	16.63	123.64	-27.64	0.04	-28.35	-14.33	0.19	177.66	1.04
400.00	-22.50	0.07	-174.56	24.31	16.42	115.94	-27.65	0.04	-32.62	-13.61	0.21	172.88	1.04
450.00	-21.75	0.08	178.30	24.20	16.22	108.25	-27.50	0.04	-36.85	-13.00	0.22	167.83	1.03
500.00	-21.03	0.09	169.99	24.08	16.00	100.62	-27.58	0.04	-41.51	-12.34	0.24	161.47	1.03
600.00	-19.61	0.10	153.97	23.81	15.51	85.48	-27.37	0.04	-49.92	-11.22	0.27	149.48	1.02
700.00	-18.47	0.12	139.35	23.51	14.98	70.47	-27.27	0.04	-59.20	-10.23	0.31	136.84	1.02
800.00	-17.42	0.13	124.90	23.24	14.52	55.61	-27.07	0.04	-67.91	-9.47	0.34	124.59	1.00
900.00	-16.41	0.15	111.53	22.93	14.01	40.94	-26.91	0.05	-77.38	-8.74	0.37	111.78	1.00
1000.00	-15.65	0.17	97.34	22.60	13.49	26.53	-26.84	0.05	-86.39	-8.14	0.39	98.87	0.99
1100.00	-14.82	0.18	84.36	22.26	12.97	12.01	-26.78	0.05	-95.91	-7.59	0.42	86.02	0.99
1200.00	-14.12	0.20	71.15	21.90	12.45	-2.07	-26.65	0.05	-104.89	-7.09	0.44	73.40	0.99
1300.00	-13.42	0.21	58.45	21.53	11.93	-16.16	-26.51	0.05	-114.31	-6.66	0.46	60.91	0.98
1400.00	-12.79	0.23	45.29	21.17	11.44	-29.99	-26.39	0.05	-123.88	-6.28	0.49	48.28	0.98
1500.00	-12.28	0.24	33.16	20.79	10.95	-43.78	-26.30	0.05	-133.56	-5.93	0.51	35.74	0.98
1600.00	-11.82	0.26	20.77	20.41	10.48	-57.28	-26.21	0.05	-143.41	-5.62	0.52	23.12	0.98
1700.00	-11.28	0.27	8.42	20.01	10.01	-70.87	-26.18	0.05	-153.08	-5.36	0.54	10.83	0.98
1800.00	-10.84	0.29	-4.59	19.61	9.56	-84.32	-26.03	0.05	-162.56	-5.10	0.56	-1.66	0.98
2000.00	-10.00	0.32	-28.82	18.82	8.73	-110.79	-25.93	0.05	177.04	-4.69	0.58	-26.23	0.99
2200.00	-9.17	0.35	-52.88	18.01	7.95	-136.87	-25.79	0.05	157.35	-4.33	0.61	-50.89	1.00
2400.00	-8.32	0.38	-76.83	17.19	7.24	-162.79	-25.76	0.05	136.84	-4.02	0.63	-75.36	1.02
2600.00	-7.53	0.42	-100.64	16.35	6.57	171.56	-25.73	0.05	116.63	-3.71	0.65	-99.83	1.04
2800.00	-6.83	0.46	-123.98	15.47	5.94	146.25	-25.84	0.05	96.02	-3.45	0.67	-123.97	1.07
3000.00	-6.20	0.49	-146.78	14.54	5.33	121.08	-25.89	0.05	75.94	-3.18	0.69	-147.89	1.09
3200.00	-5.61	0.52	-169.30	13.59	4.78	96.45	-25.97	0.05	55.46	-2.93	0.71	-171.19	1.11
3400.00	-5.06	0.56	168.41	12.63	4.28	72.21	-26.27	0.05	33.64	-2.67	0.74	165.76	1.14
3600.00	-4.57	0.59	146.57	11.60	3.80	48.42	-26.64	0.05	14.08	-2.49	0.75	143.55	1.19
4000.00	-3.76	0.65	104.60	9.59	3.02	2.32	-27.35	0.04	-25.01	-2.13	0.78	101.70	1.27
4500.00	-3.10	0.70	54.97	7.08	2.26	-52.72	-28.44	0.04	-72.83	-1.85	0.81	53.15	1.41
5000.00	-2.67	0.74	7.34	4.79	1.74	-104.83	-29.44	0.03	-115.98	-1.68	0.82	7.97	1.63
5500.00	-2.36	0.76	-38.87	2.70	1.36	-155.57	-30.04	0.03	-157.21	-1.62	0.83	-35.72	1.87
6000.00	-2.20	0.78	-83.99	0.73	1.09	154.94	-30.19	0.03	160.62	-1.65	0.83	-78.60	2.19
7000.00	-1.91	0.80	-171.06	-2.83	0.72	57.91	-30.41	0.03	68.06	-1.72	0.82	-164.43	2.81