

## FEATURES

- -55° to +100°C operation
- 19 to 40 VDC input
- Fully Isolated
- Magnetic feedback
- Fixed frequency, 600 kHz typical
- Topology – Single Ended Forward
- 80 V for up to 50 ms transient protection
- Inhibit function – input and output
- Sync function – input and output
- Output trim on single output models
- Indefinite short circuit protection
- Remote sense on single output models
- Up to 87% efficiency
- Parallelable up to 228 watts

# DC/DC CONVERTERS 28 VOLT INPUT



Size (max.): 3.005 x 1.505 x 0.400 inches (76.33 x 38.23 x 10.16 mm)  
See Section B8, case U1, for dimensions.  
Weight: 100 grams maximum  
Screening: Standard or ES. See Section C2 for screening options,  
see Section A5 for ordering information.

## MFLHP SERIES 100 WATT

MODELS	
VDC OUTPUT	
SINGLE	DUAL
5	±5
12	±12
15	±15

## DESCRIPTION

The MFLHP Series™ 28 volt DC/DC converters are rated up to 100 watts output power over a -55° to +100°C temperature range with a 28 Vdc nominal input. On dual output models, up to 70% of the rated output power can be drawn from either the positive or negative outputs. Current sharing allows the units to be paralleled for total power of up to 270 watts. The welded, hermetically sealed package is only 3.005 x 1.505 x 0.400 inches, giving the series an overall power density of up to 67 watts per cubic inch.

## DESIGN FEATURES

The MFLHP Series converters are switching regulators that use a quasi-square wave, single ended forward converter design with a constant switching frequency of 600 kHz.

Isolation between input and output circuits is provided with a transformer in the forward path and wide bandwidth magnetic coupling in the feedback control loop. The MFLHP Series uses a unique dual loop feedback technique that controls output current with an inner feedback loop and output voltage with a cascaded voltage mode feedback loop.

The additional secondary current mode feedback loop improves transient response in a manner similar to primary current mode control and allows for ease of paralleling.

Tight load regulation is achieved through a wide-bandwidth magnetic feedback circuit. The output voltage on single MFLHP models can be easily trimmed by adding an external resistor. (See Figure 1 for voltage changes with different resistor values.)

## INHIBIT

The MFLHP Series converters have two TTL compatible inhibit terminals (INH1 and INH2) that can be used to disable power conversion, resulting in a very low quiescent input current. An open collector TTL compatible low (<0.8 volts) is required between INH1 (pin 4) and Input Common (pin 2) to inhibit the converter. An open collector TTL compatible low (<0.5 volts) is required between INH2 (pin 12) and Output Common (pin 8) to inhibit the converter. The application of intermediate voltages to these pins (1.5 to 10.5 volts) should be avoided.

## CURRENT SHARING AND PARALLEL OPERATION

Multiple MFLHP converters may be used in parallel to drive a common load (see Figure 2). In this mode of operation the load current is shared by two or three MFLHP converters. In current sharing mode, one MFLHP converter is designated as a master. The SLAVE pin (pin 11) of the master is left unconnected and the MSTR/INH2 pin (pin 12) of the master is connected to the SLAVE pin (pin 11) of the slave units. The units designated as slaves have the MSTR/INH2 pin (pin 12) connected to the SNS RTN pin (pin 9). Figure 2 shows the typical setup for two or three units in parallel. Note that synchronizing the units together (though shown in the figure) is not required for current sharing operation. A second slave unit may be placed in parallel with a master and slave; this requires the TR1 pin (pin 3) of the master unit to be connected to the SNS RTN pin (pin 9).

When paralleled, 76% of the total combined power ratings of the MFLHP converters are available at the load. Overload and short circuit performance are not adversely affected during parallel operation.

CRANE

interpoint

A CRANE CO. COMPANY

B2-19

# MFLHP SERIES

## 100 WATT

# DC/DC CONVERTERS

**ABSOLUTE MAXIMUM RATINGS**

**Input Voltage**

- 19 to 40 VDC

**Power Dissipation (Pd)**

- 20 watts

**Output Power**

- 80 to 100 watts depending on model

**Lead Soldering Temperature (10 sec per lead)**

- 300°C

**Storage Temperature Range (Case)**

- 65°C to +150°C

**RECOMMENDED OPERATING CONDITIONS**

**Input Voltage Range**

- 19 to 40 VDC continuous
- 80 V for 50 msec transient

**Case Operating Temperature (Tc)**

- 55 to +100°C full power
- 55 to +135°C absolute

**Derating Output Power/Current**

- Linearly from 100% at 100°C to 0% at 135°C

**SYNC IN AND INHIBIT (INH1, INH2)**

**Sync In (525 to 675 kHz)**

- Duty cycle 40% min, 60% max
- Logic low 0.8 V max
- Logic high 4.5 V min
- Referenced to input common
- If not used, connect to input common

**Sync Out - Referenced to input common**

**Inhibit (INH1, INH2) TTL Open Collector**

- Logic low (output disabled)
  - Current -10 to -5 mA
  - INH1 referenced to input common
    - Logic low 0.8 V max
  - INH2 referenced to output common
    - Logic low 0.5 V max
- Logic high (output enabled)
  - Open collector

**TYPICAL CHARACTERISTICS**

**Output Voltage Temperature Coefficient**

- 100 ppm/°C typical

**Input to Output Capacitance**

- 150 pF typical

**Isolation**

- 100 megohm minimum at 500 V

**Audio Rejection**

- 50 dB typical

**Conversion Frequency**

- Free run mode 600 kHz typical
  - 550 kHz min, 650 kHz. max
- External sync range 525 to 675 kHz

**Inhibit Pin Voltage (unit enabled)**

- INH1 = 9 to 12 V, INH2 = 6 to 9 V

**PINS NOT USED**

**TR1, Master, and Slave**

If not used, leave unconnected

**Electrical Characteristics: -50°C to +100°C Tc, 28 VDC Vin, 100% load, free run, unless otherwise specified.**

SINGLE OUTPUT MODELS		MFLHP2805S			MFLHP2812S			MFLHP2815S			UNITS	
PARAMETER	CONDITION	MIN	TYP	MAX	MIN	TYP	MAX	MIN	TYP	MAX		
OUTPUT VOLTAGE	25°C	4.95	5.00	5.05	11.88	12.00	12.12	14.85	15.00	15.15	VDC	
OUTPUT CURRENT	V <sub>IN</sub> = 19 to 40 VDC	0	—	16	0	—	7.5	0	—	6.67	A	
OUTPUT POWER	V <sub>IN</sub> = 19 to 40 VDC	0	—	80	0	—	90	0	—	100	W	
OUTPUT RIPPLE	Tc = 25°C	—	15	35	—	30	75	—	30	85	mV p-p	
VOLTAGE 10 k - 2 MHz	Tc = -55°C to +100°C	—	30	75	—	45	125	—	45	150	mV p-p	
LINE REGULATION	V <sub>IN</sub> = 19 to 40 VDC	—	0	20	—	0	20	—	0	20	mV	
LOAD REGULATION	NO LOAD TO FULL	—	0	20	—	0	20	—	0	20	mV	
INPUT VOLTAGE	CONTINUOUS	19	28	40	19	28	40	19	28	40	VDC	
	TRANSIENT <sup>1</sup> 50 ms	—	—	80	—	—	80	—	—	80	V	
INPUT CURRENT	NO LOAD	—	70	120	—	50	80	—	50	80	mA	
	FULL LOAD	—	3.6	3.73	—	3.8	3.95	—	4.2	4.40	A	
	INHIBITED - INH1	—	9	14	—	9	14	—	9	14	mA	
	INHIBITED - INH2	—	35	70	—	35	70	—	35	70	mA	
INPUT RIPPLE CURRENT	10 kHz - 10 MHz	—	15	50	—	15	50	—	15	50	mA pp	
EFFICIENCY	Tc = 25°C	77	80	—	83	86	—	84	87	—	%	
LOAD FAULT <sup>2</sup>	POWER DISSIPATION SHORT CIRCUIT	Tc = 25°C	—	15	20	—	15	20	—	15	20	W
		RECOVERY	—	1.5	4	—	1.5	4	—	1.5	4	ms
STEP LOAD RESP.	50% - 100% - 50%	TRANSIENT	—	350	450	—	450	700	—	450	700	mV pk
		RECOVERY <sup>3</sup>	—	1.5	3.0	—	1.5	3.0	—	1.5	3.0	ms
STEP LINE RESP.	19 - 40 - 19 VDC	TRANSIENT <sup>4</sup>	—	250	400	—	250	400	—	250	400	mV pk
		RECOVERY <sup>3</sup>	—	200	300	—	200	300	—	200	300	µs
		DELAY	—	3.5	6	—	3.5	6	—	3.5	6	ms
START-UP	OVERSHOOT	—	0	25	—	0	50	—	0	50	mV pk	

**Notes**

- Unit will shut down above approximately 45V but will be undamaged and will restart when voltage drops into normal range.
- Indefinite short circuit protection not guaranteed above 100°C case.
- Recovery time is measured from application of the transient to point at which V<sub>out</sub> is within 1% of final value.
- Transition time ≥ 10 µs.

# DC/DC CONVERTERS

# MFLHP SERIES 100 WATT

Electrical Characteristics: -55°C to +100°C Tc, 28 VDC Vin, 100% load, free run, unless otherwise specified.

DUAL OUTPUT MODELS		MFLHP2805D			MFLHP2812D			MFLHP2815D			UNITS
PARAMETER	CONDITIONS	MIN	TYP	MAX	MIN	TYP	MAX	MIN	TYP	MAX	
OUTPUT VOLTAGE Tc = 25°C	+V <sub>OUT</sub>	4.95	5.00	5.05	11.88	12.00	12.12	14.85	15.00	15.15	VDC
	-V <sub>OUT</sub>	4.92	5.00	5.08	11.82	12.00	12.18	14.77	15.00	15.23	
OUTPUT CURRENT <sup>1</sup> V <sub>IN</sub> = 19 TO 40 VDC	EACH OUTPUT	0	—	11.2	0	—	5.3	0	—	4.67	A
	TOTAL	0	—	16.0	0	—	7.5	0	—	6.67	
OUTPUT POWER V <sub>IN</sub> = 19 TO 40 VDC	EACH OUTPUT	0	—	56	0	—	63	0	—	70	W
	TOTAL	0	—	80	0	—	90	0	—	100	
OUTPUT RIPPLE VOLTAGE 10 kHz - 2 MHz	+V <sub>OUT</sub>	—	25	125	—	50	150	—	50	200	mV p-p
	-V <sub>OUT</sub>	—	25	125	—	50	150	—	50	200	
LINE REGULATION V <sub>IN</sub> = 19 TO 40 VDC	+V <sub>OUT</sub>	—	0	50	—	0	50	—	0	50	mV
	-V <sub>OUT</sub>	—	25	100	—	25	100	—	25	100	
LOAD REGULATION NO LOAD TO FULL	+V <sub>OUT</sub>	—	0	50	—	10	100	—	10	100	mV
	-V <sub>OUT</sub>	—	25	100	—	50	200	—	50	200	
CROSS REGULATION Tc = 25°C	SEE NOTE 2	—	6	8	—	2	4	—	2	4	%
	SEE NOTE 3	—	3	6	—	2	4	—	2	4	
INPUT VOLTAGE NO LOAD TO FULL	CONTINUOUS	19	28	40	19	28	40	19	28	40	VDC
	TRANSIENT <sup>4</sup> 50 ms	0	—	80	0	—	80	0	—	80	V
INPUT CURRENT Tc = 25°C	NO LOAD	—	50	120	—	50	100	—	550	100	mA
	FULL LOAD	—	3.6	—	—	3.8	—	—	4.2	—	A
	INHIBITED - INH1	—	9	14	—	9	14	—	9	14	mA
	INHIBITED - INH2	—	35	70	—	35	70	—	35	70	
INPUT RIPPLE CURRENT 10 kHz - 10 MHz		—	15	50	—	15	50	—	15	50	mA p-p
EFFICIENCY 25°C Tc	BALANCED LOAD	77	80	—	83	86	—	84	87	—	%
LOAD FAULT <sup>5</sup> Tc = 25°C	POWER DISSIPATION SHORT CIRCUIT	—	15	20	—	15	20	—	15	20	W
	RECOVERY	—	1.5	4.0	—	1.5	4.0	—	1.5	4.0	ms
STEP LOAD RESPONSE ± V <sub>OUT</sub>	50 %-100%-50% LOAD TRANSIENT	—	350	450	—	450	700	—	450	700	mV pk
	RECOVERY <sup>6</sup>	—	1.5	3.0	—	1.5	3.0	—	1.5	3.0	ms
STEP LINE RESPONSE ± V <sub>OUT</sub>	19 - 40 - 16 V <sub>IN</sub> TRANSIENT <sup>7</sup>	—	250	400	—	250	400	—	250	400	mV pk
	RECOVERY <sup>6</sup>	—	200	300	—	200	300	—	200	300	μs
START-UP	DELAY	—	3.5	6	—	3.5	6	—	3.5	6	ms
	OVERSHOOT	—	0	25	—	0	50	—	0	50	mV p

#### Notes

- Up to 70% of the total output power is available from either output providing the opposite output is simultaneously carrying 30% of the total power.
- Effect on the negative output under the following conditions:  
+P<sub>out</sub> 30% to 70%; -P<sub>out</sub> 70% to 30%
- Effect on the negative output under the following conditions:  
+P<sub>out</sub> 50%; -P<sub>out</sub> 10% to 50%
- Unit will shut down above approximately 45V but will be undamaged and will restart when voltage drops into normal range.
- Indefinite short circuit protection not guaranteed above 100°C case.
- Recovery time is measured from application of the transient to point at which V<sub>out</sub> is within 1% of final value.
- Transition time ≥ 10 μs.

**MFLHP SERIES  
100 WATT**

**DC/DC CONVERTERS**

**SINGLE OUTPUT MODELS CONNECTION DIAGRAMS - SENSE AND PARALLEL**

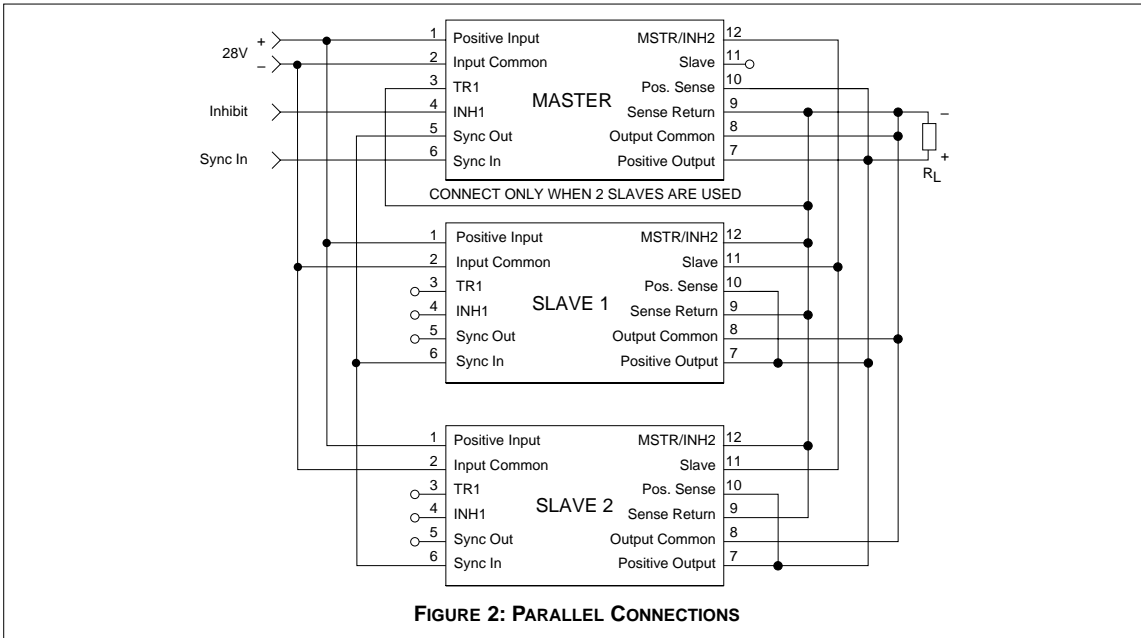
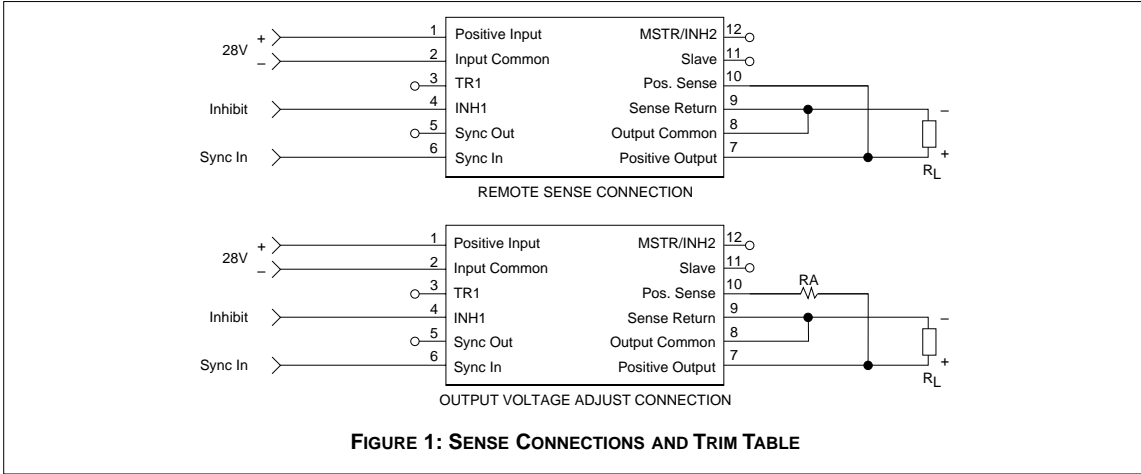

# DC/DC CONVERTERS

# MFLHP SERIES 100 WATT

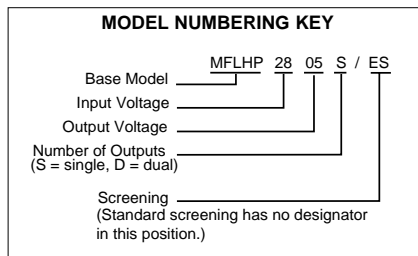
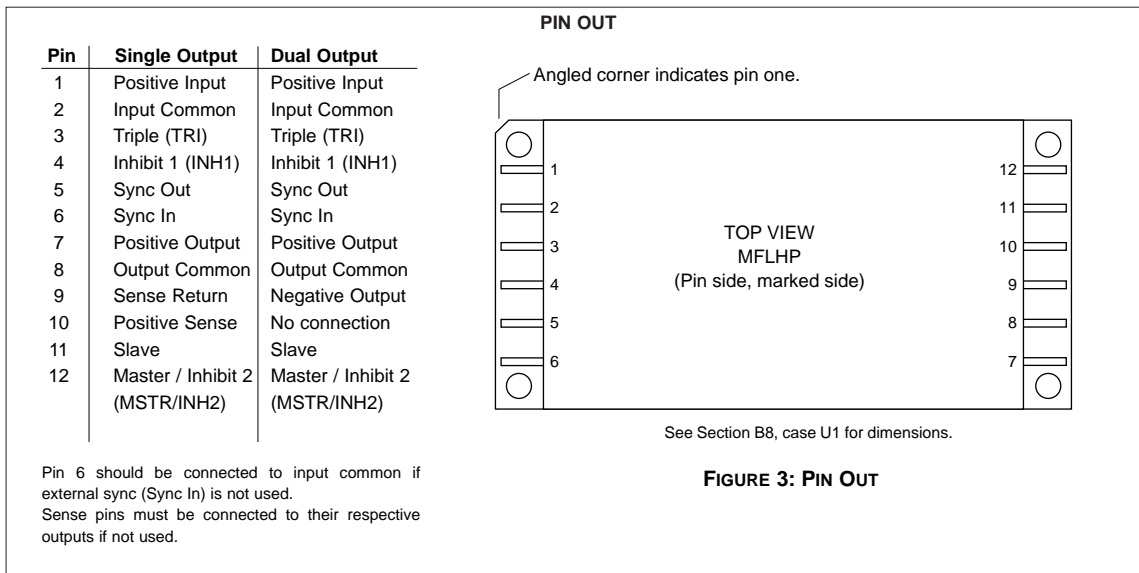

Typical Performance Curves: 25°C Tc , 28 VDC Vin, 100% load, free run, unless otherwise specified.

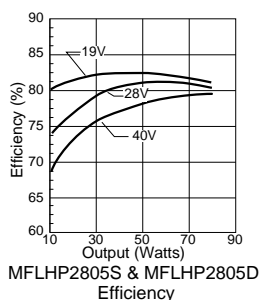

**FIGURE 4**

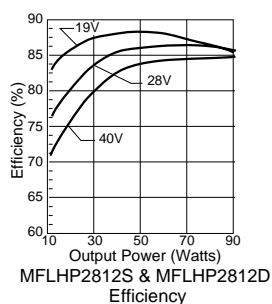

**FIGURE 5**

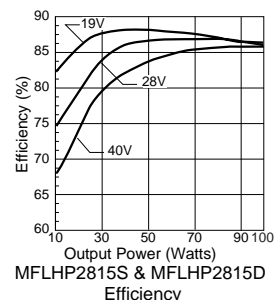

**FIGURE 6**

# MFLHP SERIES 100 WATT

# DC/DC CONVERTERS

Typical Performance Curves: 25°C Tc , 28 VDC Vin, 100% load, free run, unless otherwise specified.

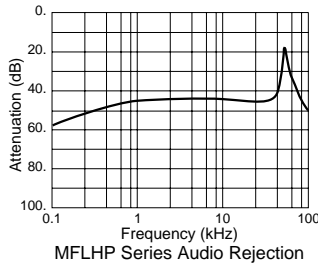
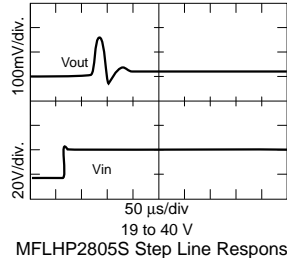
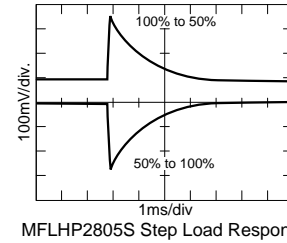

FIGURE 7



MFLHP2805S Step Line Response

FIGURE 8



MFLHP2805S Step Load Response

FIGURE 9

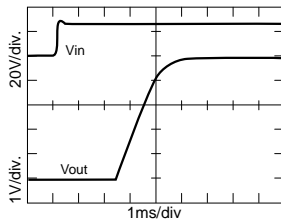

MFLHP2805S Turn On Response

FIGURE 10

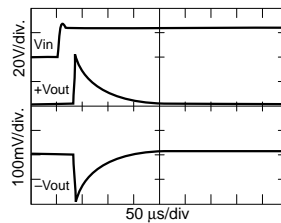

MFLHP2815D Step Line Response

FIGURE 11

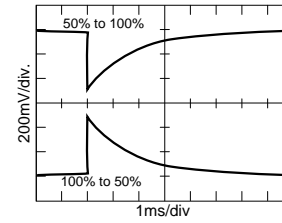

MFLHP2815D Step Load Response

FIGURE 12

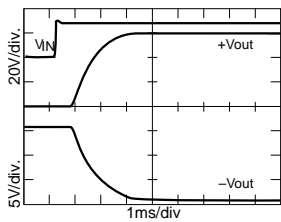

MFLHP2815D Turn On Response

FIGURE 13

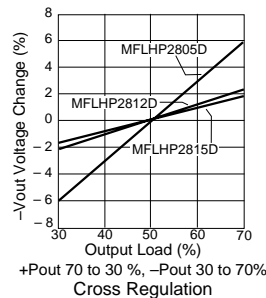

+Pout 70 to 30 %, -Pout 30 to 70%  
Cross Regulation

FIGURE 14

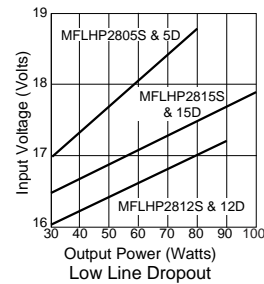

Low Line Dropout

FIGURE 15

# CASE U

# CASES

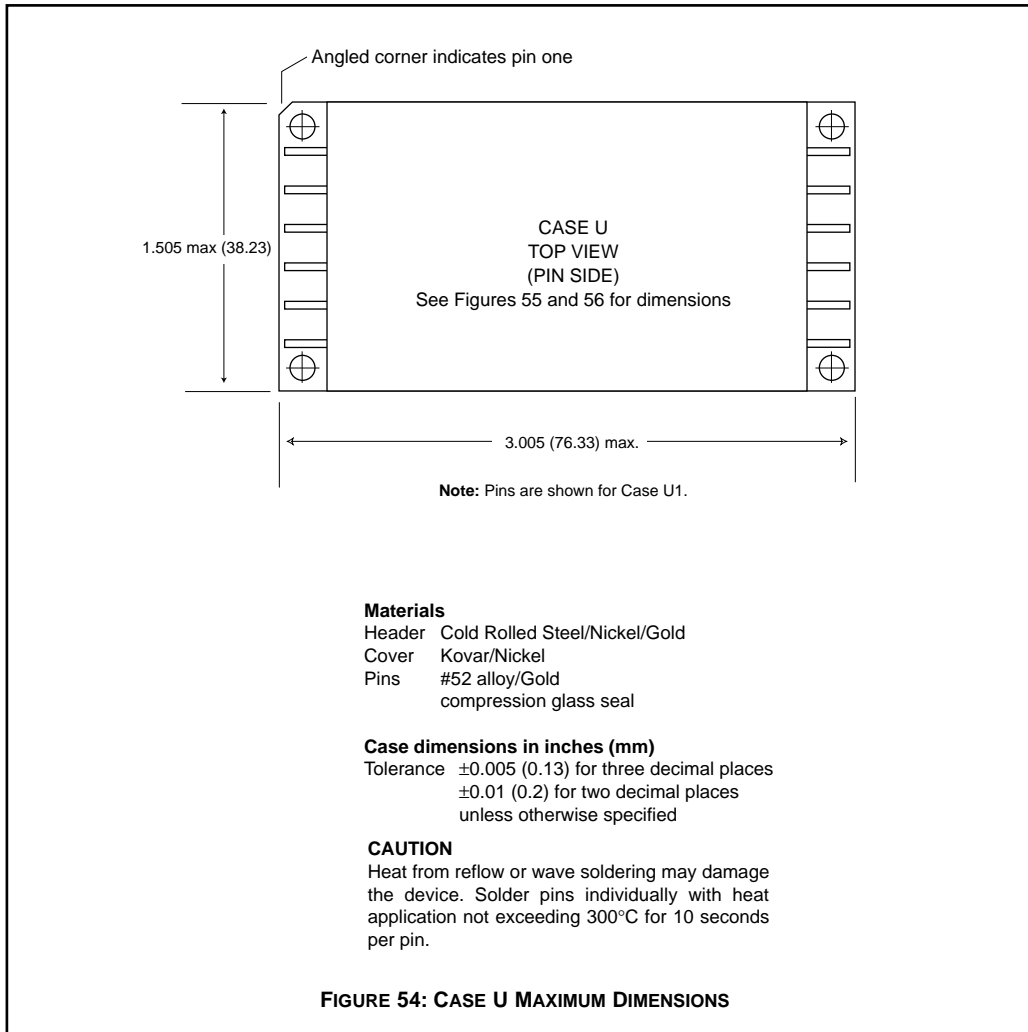

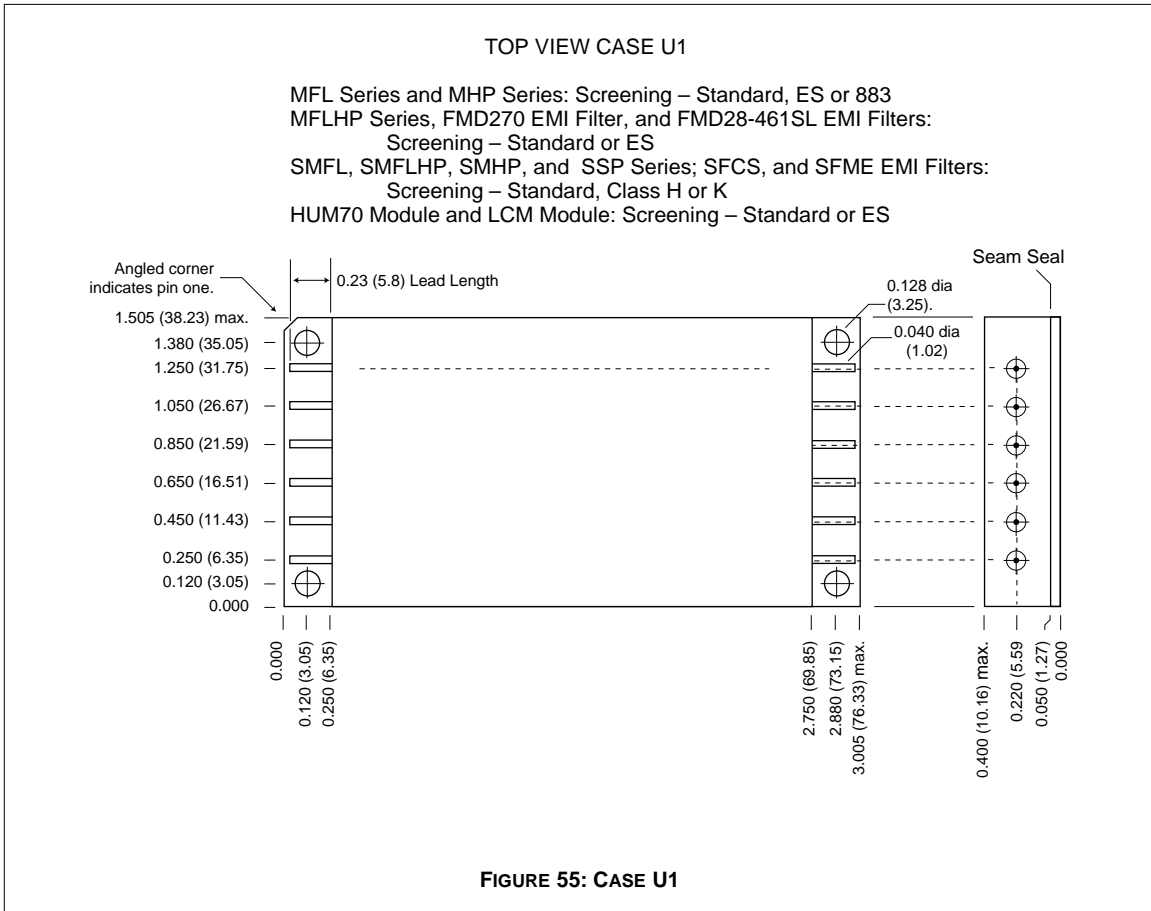



**QA SCREENING  
125°C PRODUCTS**

**125°C PRODUCTS**

<b>TEST (125°C Products)</b>	<b>STANDARD</b>	<b>/ES</b>	<b>/883 (Class H)*</b>
PRE-CAP INSPECTION Method 2017, 2032	yes	yes	yes
TEMPERATURE CYCLE (10 times) Method 1010, Cond. C, -65°C to 150°C Method 1010, Cond. B, -55°C to 125°C	no no	no yes	yes no
CONSTANT ACCELERATION Method 2001, 3000 g Method 2001, 500 g	no no	no yes	yes no
BURN-IN Method 1015, 160 hours at 125°C 96 hours at 125°C case (typical)	no no	no yes	yes no
FINAL ELECTRICAL TEST MIL-PRF-38534, Group A Subgroups 1 through 6: -55°C, +25°C, +125°C Subgroups 1 and 4: +25°C case	no yes	no yes	yes no
HERMETICITY TESTING Fine Leak, Method 1014, Cond. A Gross Leak, Method 1014, Cond. C Gross Leak, Dip (1 x 10 <sup>-3</sup> )	no no yes	yes yes no	yes yes no
FINAL VISUAL INSPECTION Method 2009	yes	yes	yes

Test methods are referenced to MIL-STD-883 as determined by MIL-PRF-38534.

\*883 products are built with element evaluated components and are 100% tested and guaranteed over the full military temperature range of -55°C to +125°C.

Applies to the following products

MOR Series	MHD Series	MGH Series	FMGA EMI Filter
MFLHP Series	MHV Series	MCH Series	FMSA EMI Filter
MFL Series	MHF+ Series	FM-704A EMI Filter	HUM Modules**
MHP Series	MHF Series**	FMD**/FME EMI Filter	LCM Modules**
MTR Series	MGA Series	FMC EMI Filter	LIM Modules
MQO Series**	MSA Series	FMH EMI Filter	

\*\*MFLHP Series, MQO Series, MHF Series, FMD EMI Filters, Hum Modules, and LCM Modules do not offer '883' screening.