

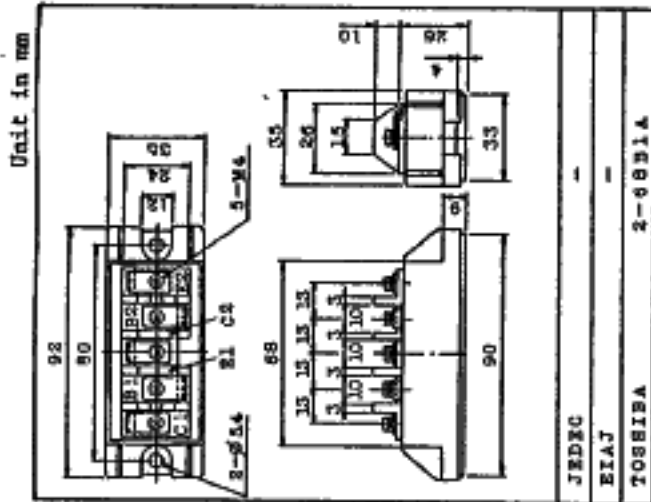

SEMICONDUCTOR
TECHNICAL DATA

MG15N2CK1
MG15N6EK1



MG15N2CK1

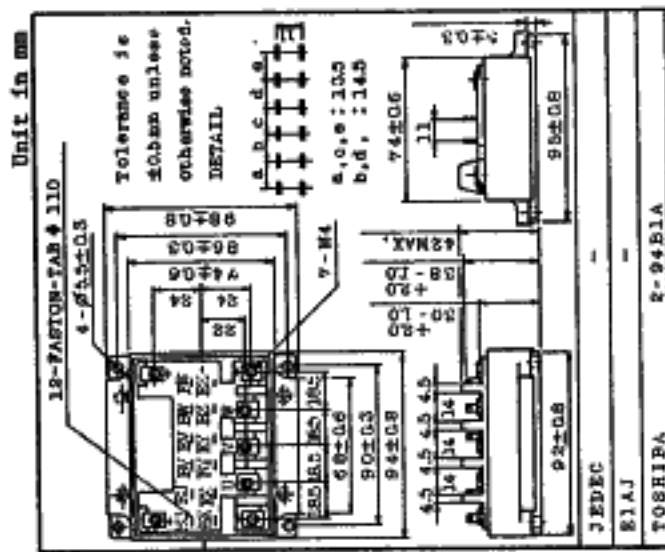
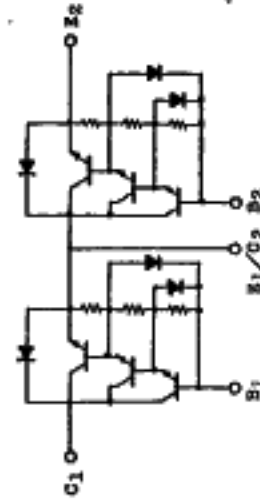

MG15N6EK1

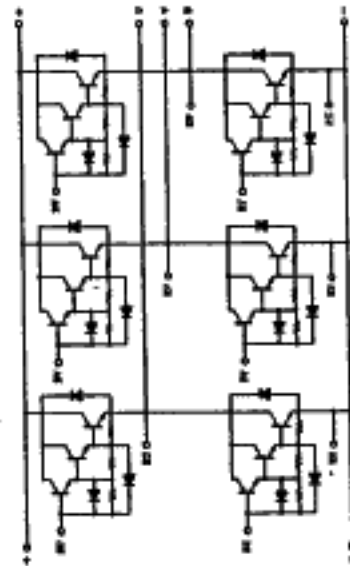

TOSHIBA CORPORATION



SEMICONDUCTOR TECHNICAL DATA

MG15N2CK1
MG15N6EK1

MAXIMUM RATINGS (Ta=25°C)

CHARACTERISTIC		SYMBOL	RATING	UNIT
Collector-Base Voltage		VCBO	1100	V
Collector-Emitter Sustaining Voltage		VCEX(SUS)	1100	V
Collector-Emitter Sustaining Voltage		VCEO(SUS)	900	V
Emitter-Base Voltage		VEBO	7	V
Collector Current	DC	IC	15	A
	1ms	ICP	30	A
Forward Current	DC	IF	15	A
	1ms	IFM	30	A
Base Current		IB	1.5	A
Collector Power Dissipation (Tc=25°C)		PC	150	W
Junction Temperature		Tj	150	°C
Storage Temperature Range		Tstg	-40-125	°C
Isolation Voltage		VIsol	2500 (AC 1 Minute)	V
Screw Torque (Terminal/Mounting)		-	20/30	kg·cm

ELECTRICAL CHARACTERISTICS (Ta=25°C)

CHARACTERISTIC		SYMBOL	TEST CONDITION	MIN.	TYP.	MAX.	UNIT
Collector Cut-off Current		ICBO	VCE=1100V, IE=0	-	-	1.0	mA
Emitter Cut-off Current		IEBO	VEB=7V, IC=0	-	-	200	mA
Collector-Emitter Sustaining Voltage		VCEO(SUS)	IC=1A, L=40mH	900	-	-	V
DC Current Gain		hFE	VCE=5V, IC=15A	100	-	-	
Collector-Emitter Saturation Voltage		VCE(sat)	IC=15A, IB=0.3A	-	1.8	2.5	V
Base-Emitter Saturation Voltage		VBE(sat)		-	2.6	3.5	
Switching Time	Turn-on Time	ton	<p>50ns 40pF VCC=600V IB1=0.5A, IB2=-0.9A DUTY CYCLE=0.5%</p>	-	0.5	2.0	μs
	Storage Time	tstg		-	8	11	
	Fall Time	tf		-	4	6	
Forward Voltage		Vf	IF=15A, IB=0	-	1.0	1.5	V
Reverse Recovery Time		trr	IF=15A, VBE=-3V di/dt=60A/μs	-	0.5	1.0	μs
Thermal Resistance		Rth(j-c)	Transistor	-	-	0.83	°C/W
			Diode	-	-	1.3	

TOSHIBA CORPORATION

GT1A2A



SEMICONDUCTOR TECHNICAL DATA

MG15N2CK1
MG15N6EK1

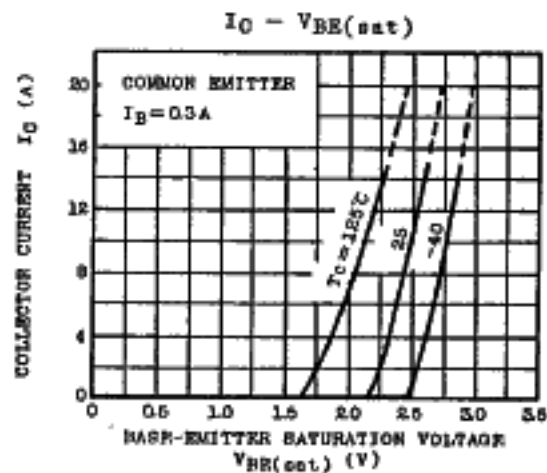
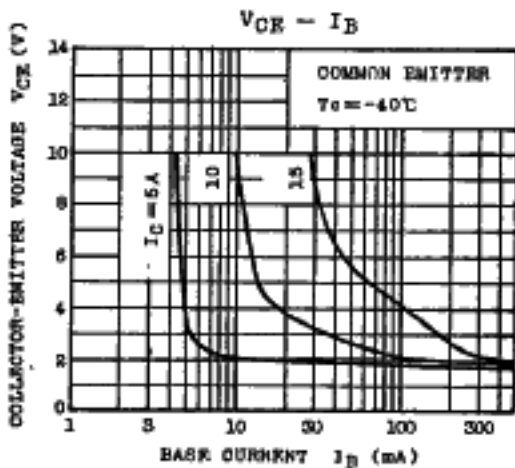
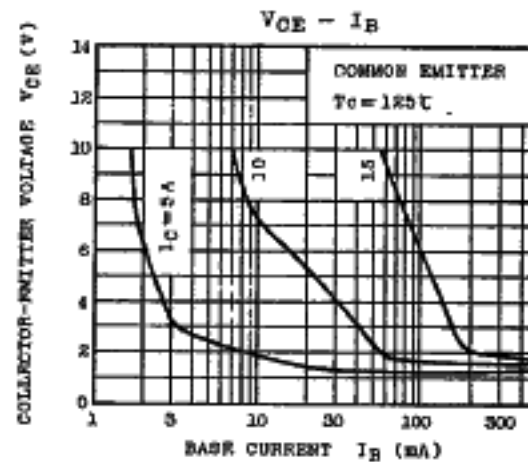
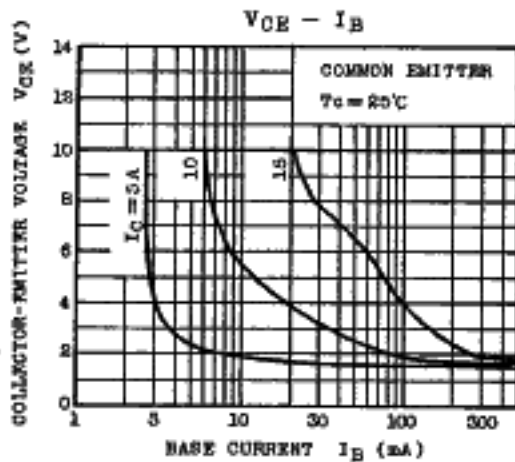
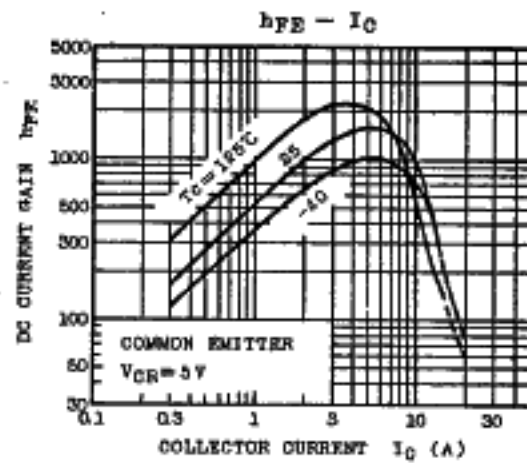
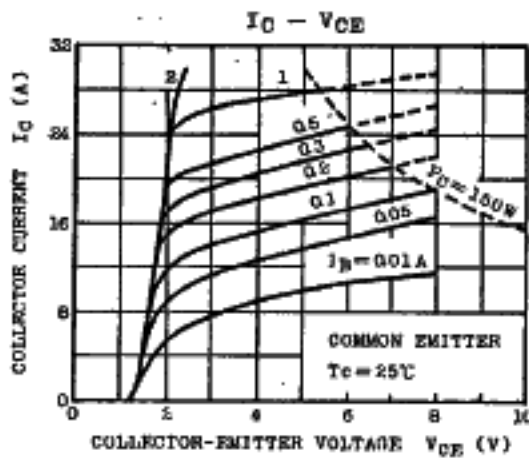

TOSHIBA CORPORATION

GT1A2A



SEMICONDUCTOR TECHNICAL DATA

MG15N2CK1

MG15N6EK1

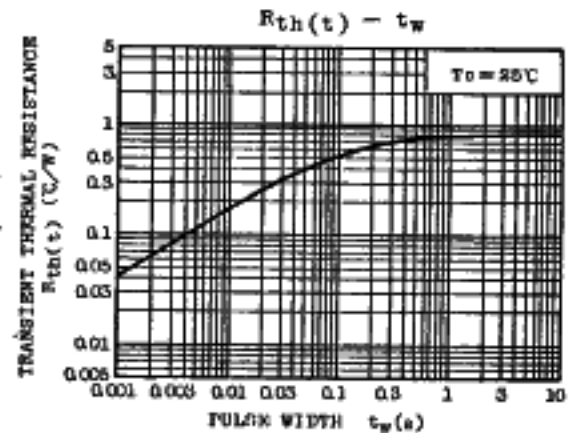
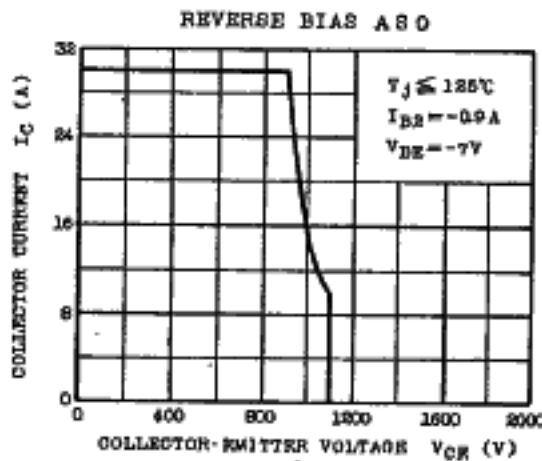
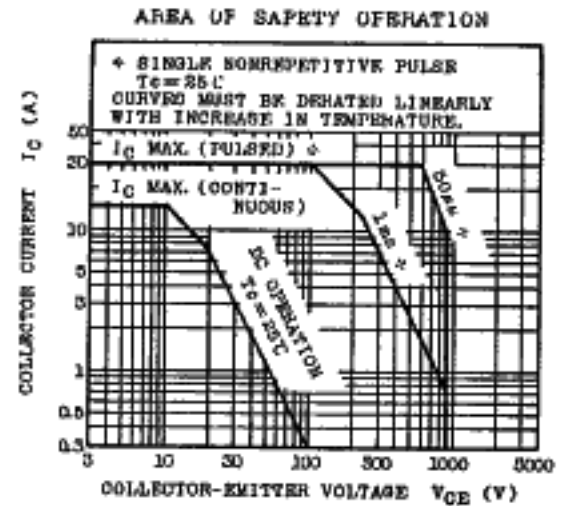
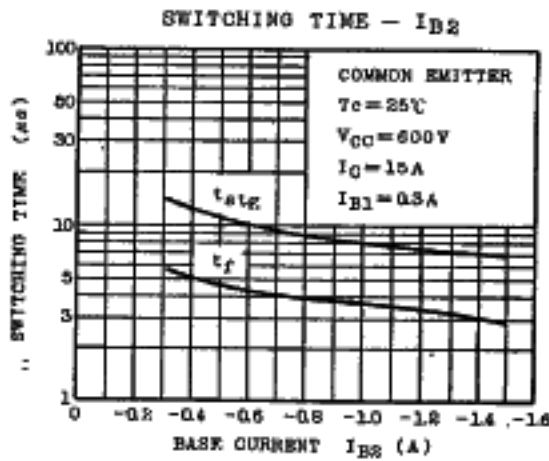
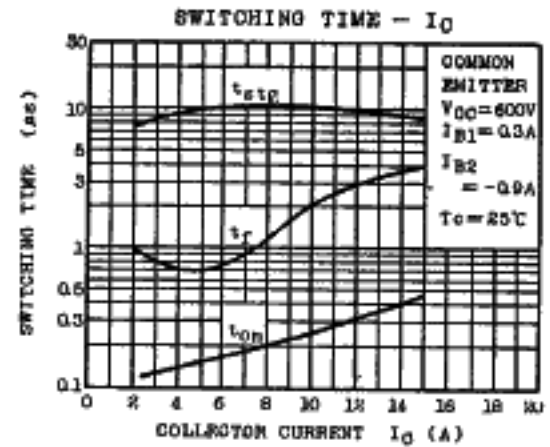
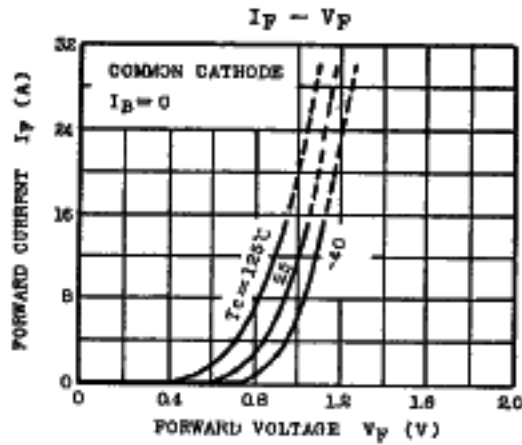

TOSHIBA CORPORATION

GT1A2A



SEMICONDUCTOR TECHNICAL DATA

MG15N2CK1

MG15N6EK1

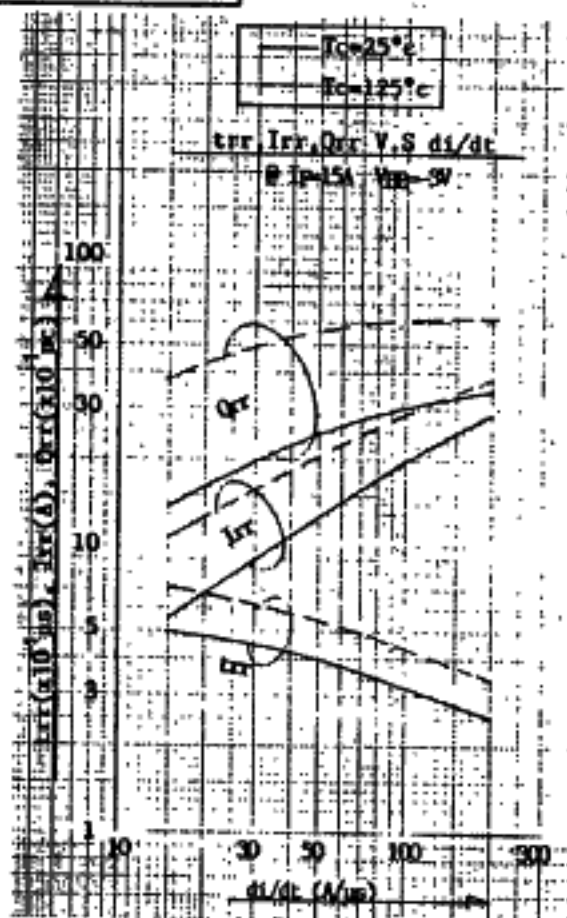

TOSHIBA CORPORATION

GT1A2A