

# INFRARED RECEIVER MODULE

# MIM-R1AA38-1

## Description

The MIM-R1AA38-1 series are 37.9 KHz miniaturized infrared receivers for remote control and other applications requiring improved ambient light rejection. The separate PIN diode and preamplifier IC are assembled on a single leadframe. The epoxy package contains a special IR filter. This module has excellent performance even in disturbed ambient light applications and provides protection against uncontrolled output pulses.

## Package Dimensions



## Features

- Photo detector and preamplifier in one package
- Internal filter for PCM frequency
- High immunity against ambient light
- Improved shielding against electric field disturbance
- 5-Volt supply voltage; low power consumption
- TTL and CMOS compatibility

MIM-R1AA38-1

unit : mm

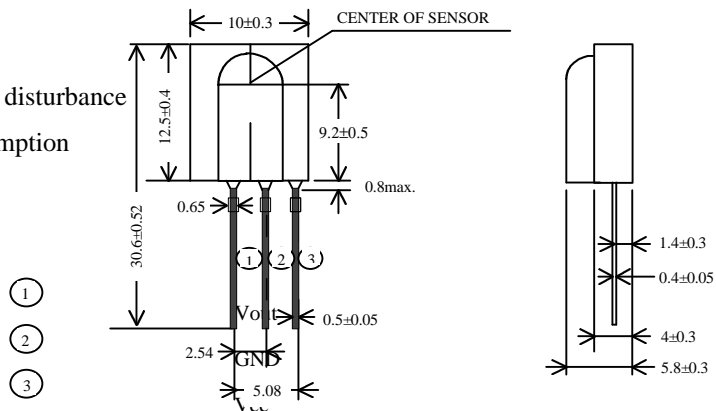

Notes :

1. Tolerance is  $\pm 0.25$  mm (.010") unless otherwise noted.
2. Lead spacing is measured where the leads emerge from the package.

## BLOCK DIAGRAM

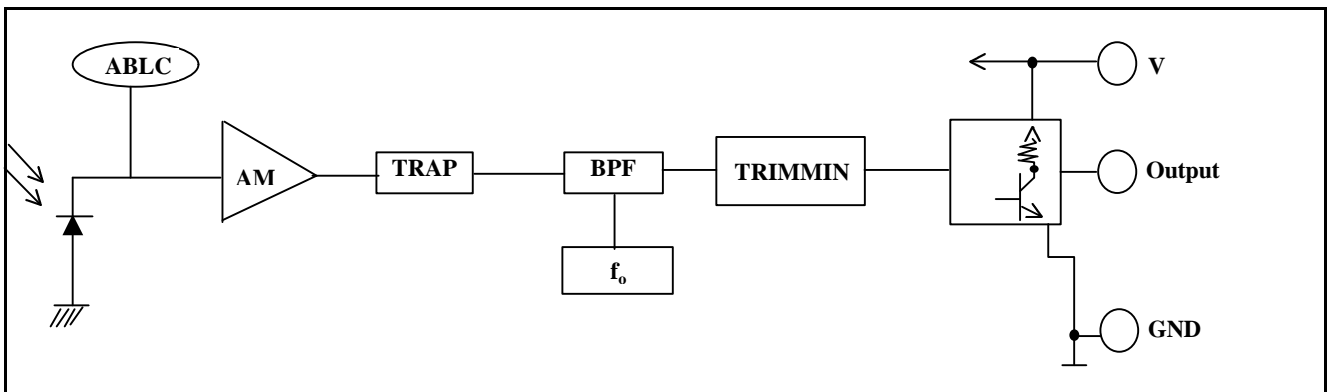

Unity Opto Technology Co., Ltd.

07/26/2000

# MIM-R1AA38-1

## Absolute Maximum Ratings

@  $T_A=25^\circ\text{C}$

Item	Symbol	Ratings	Unit	Remark
Supply voltage	$V_{CC}$	5.8	V	
Operating temperature	$T_{opr}$	-10 ~ + 60	$^\circ\text{C}$	
Storage temperature	$T_{stg}$	-20 ~ + 75	$^\circ\text{C}$	
Soldering temperature	$T_{sd}$	260	$^\circ\text{C}$	Maximum 5 seconds
Power Dissipation	$P_D$	17.5	mW	$V_{CC}=+5.0\text{V}$ ; under no signal

## Electro-optical characteristics (Vcc=5V)

@  $T_A=25^\circ\text{C}$

Parameter	Symbol	Min.	Typ.	Max.	Unit	Remarks
Current consumption	$I_{cc}$			5.0	mA	Under no signal
Response wavelength	$\lambda_p$		940		nm	
Tuning frequency	$f_0$		37.9		$\text{KHz}$	
Output form	----- active low output -----					
H level output voltage	$V_{0h}$	4.2			V	
L level output voltage	$V_{0l}$			0.5	V	
H level output pulse width	$T_{wh}$	400		800	$\mu\text{s}$	
L level output pulse width	$T_{wl}$	400		800	$\mu\text{s}$	
Distance between emitter & detector	L	10.0			m	Note 1
Half angle	$\Delta\theta$	$\pm 16$	$\pm 55$		deg	Horizontal direction

## Test Method

### A. Standard Transmitter

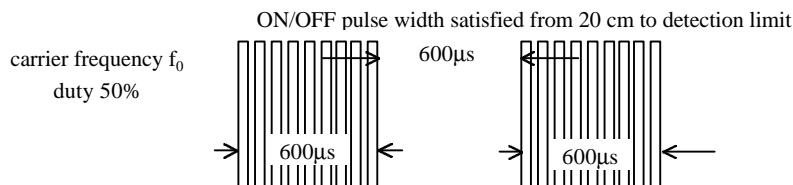

Fig 1. Burst Wave

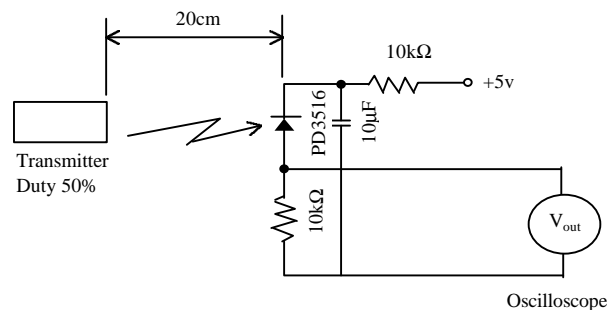
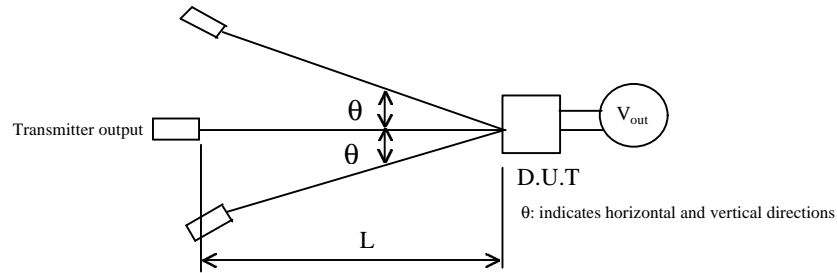
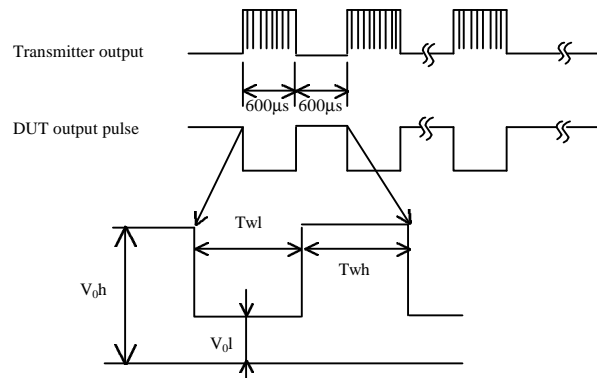

Fig 2. Standard Transmitter Measurement

**B. Detection Length Test**



**C. Pulse Width Test**



**CHARACTERISTIC CURVES ( $T_A=25^\circ\text{C}$ )**

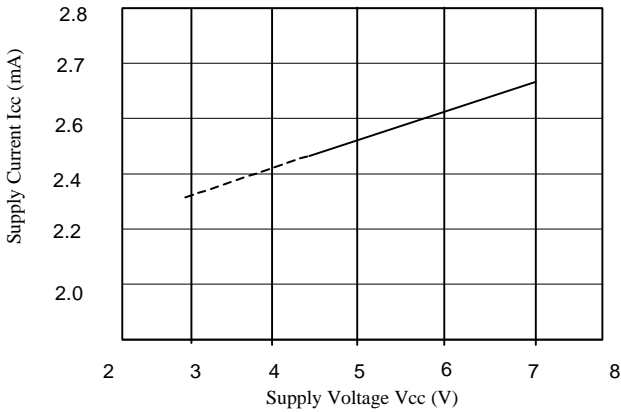

SUPPLY VOLTAGE vs. SUPPLY CURRENT

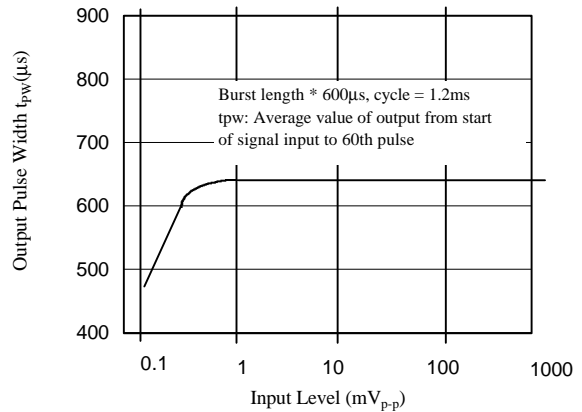

INPUT LEVEL vs. OUTPUT PULSE WIDTH

NOTE 1. Distance between emitter & detector specifies maximum distance that output wave form satisfies

the standard under the conditions below against the standard transmitter.

(1) Measuring place .....Indoor without extreme reflection of light.

(2) Ambient light source...Detecting surface illumination shall be  $200 \pm 50$  Lux under ordinary  
hite fluorescense lamp of no high frequency lighting.

(3) Standard transmitter ...Burst wave indicated in Fig 1. of standard transmitter

shall be arranged to 50mV<sub>p-p</sub> under the measuring circuit specified in Fig 2.