

High-Voltage — High Power Transistors

... designed for use in high power audio amplifier applications and high voltage switching regulator circuits.

- High Collector–Emitter Sustaining Voltage —

NPN	PNP
$V_{CE(sus)} = 140 \text{ Vdc}$	$V_{CE(sus)} = 160 \text{ Vdc}$
MJE4342	MJE4352
MJE4343	MJE4353
- High DC Current Gain — @ $I_C = 8.0 \text{ Adc}$
 $h_{FE} = 35 \text{ (Typ)}$
- Low Collector–Emitter Saturation Voltage —
 $V_{CE(sat)} = 2.0 \text{ Vdc (Max) @ } I_C = 8.0 \text{ Adc}$

MAXIMUM RATINGS

Rating	Symbol	MJE4342 MJE4352	MJE4343 MJE4353	Unit
Collector–Emitter Voltage	V_{CEO}	140	160	Vdc
Collector–Base Voltage	V_{CB}	140	160	Vdc
Emitter–Base Voltage	V_{EB}	7.0		Vdc
Collector Current — Continuous Peak (1)	I_C	16 20		Adc
Base Current — Continuous	I_B	5.0		Adc
Total Power Dissipation @ $T_C = 25^\circ\text{C}$	P_D	125		Watts
Operating and Storage Junction Temperature Range	T_J, T_{stg}	–65 to +150		$^\circ\text{C}$

THERMAL CHARACTERISTICS

Characteristic	Symbol	Max	Unit
Thermal Resistance, Junction to Case	$R_{\theta JC}$	1.0	$^\circ\text{C/W}$

(1) Pulse Test: Pulse Width $\leq 5.0 \mu\text{s}$, Duty Cycle $\geq 10\%$.

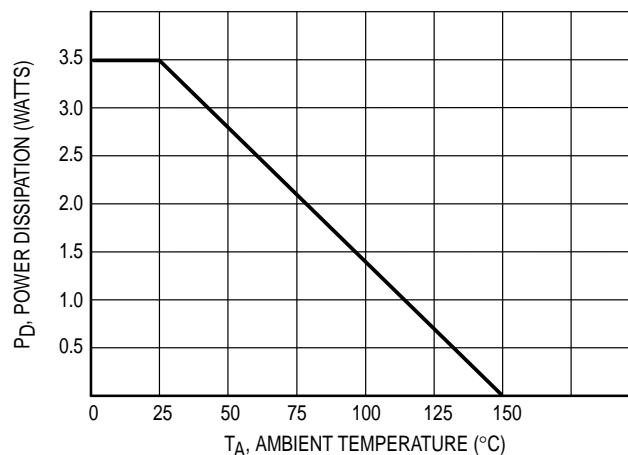

Figure 1. Power Derating
Reference: Ambient Temperature

NPN
MJE4342

MJE4343
PNP
MJE4352

MJE4353

16 AMPERE
POWER TRANSISTORS
COMPLEMENTARY
SILICON
140–160 VOLTS

CASE 340D-01
TO-218 TYPE

MJE4342 MJE4343 MJE4352 MJE4353

ELECTRICAL CHARACTERISTICS ($T_C = 25^\circ\text{C}$ unless otherwise noted)

Characteristic	Symbol	Min	Max	Unit
OFF CHARACTERISTICS				
Collector–Emitter Sustaining Voltage (1) ($I_C = 200\text{ mAdc}$, $I_B = 0$)	$V_{CEO(sus)}$	140 160	— —	Vdc
Collector–Emitter Cutoff Current ($V_{CE} = 70\text{ Vdc}$, $I_B = 0$) ($V_{CE} = 80\text{ Vdc}$, $I_B = 0$)	I_{CEO}	— —	750 750	μAdc
Collector–Emitter Cutoff Current ($V_{CE} = \text{Rated } V_{CB}$, $V_{EB(off)} = 1.5\text{ Vdc}$) ($V_{CE} = \text{Rated } V_{CB}$, $V_{EB(off)} = 1.5\text{ Vdc}$, $T_C = 150^\circ\text{C}$)	I_{CEX}	— —	1.0 5.0	mAdc
Collector–Base Cutoff Current ($V_{CB} = \text{Rated } V_{CB}$, $I_E = 0$)	I_{CBO}	—	750	μAdc
Emitter–Base Cutoff Current ($V_{BE} = 7.0\text{ Vdc}$, $I_C = 0$)	I_{EBO}	—	1.0	mAdc

ON CHARACTERISTICS (1)

DC Current Gain ($I_C = 8.0\text{ Adc}$, $V_{CE} = 2.0\text{ Vdc}$) ($I_C = 16\text{ Adc}$, $V_{CE} = 4.0\text{ Vdc}$)	h_{FE}	15 8.0	35 (Typ) 15 (Typ)	—
Collector–Emitter Saturation Voltage ($I_C = 8.0\text{ Adc}$, $I_B = 800\text{ mA}$) ($I_C = 16\text{ Adc}$, $I_B = 2.0\text{ Adc}$)	$V_{CE(sat)}$	— —	2.0 3.5	Vdc
Base–Emitter Saturation Voltage ($I_C = 16\text{ Adc}$, $I_B = 2.0\text{ Adc}$)	$V_{BE(sat)}$	—	3.9	Vdc
Base–Emitter On Voltage ($I_C = 16\text{ Adc}$, $V_{CE} = 4.0\text{ Vdc}$)	$V_{BE(on)}$	—	3.9	Vdc

DYNAMIC CHARACTERISTICS

Current–Gain — Bandwidth Product (2) ($I_C = 1.0\text{ Adc}$, $V_{CE} = 20\text{ Vdc}$, $f_{test} = 0.5\text{ MHz}$)	f_T	1.0	—	MHz
Output Capacitance ($V_{CB} = 10\text{ Vdc}$, $I_E = 0$, $f = 0.1\text{ MHz}$)	C_{ob}	—	800	pF

(1) Pulse Test: Pulse Width $\leq 300\ \mu\text{s}$, Duty Cycle $\geq 2.0\%$.

(2) $f_T = |h_{fe}| \cdot f_{test}$.

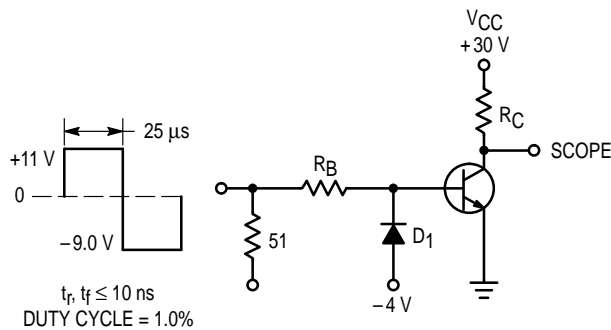

R_B and R_C VARIED TO OBTAIN DESIRED CURRENT LEVELS
 D_1 MUST BE FAST RECOVERY TYPE, e.g.:
 1N5825 USED ABOVE $I_B \approx 100\text{ mA}$
 MSD6100 USED BELOW $I_B \approx 100\text{ mA}$

Note: Reverse polarities to test PNP devices.

Figure 2. Switching Times Test Circuit

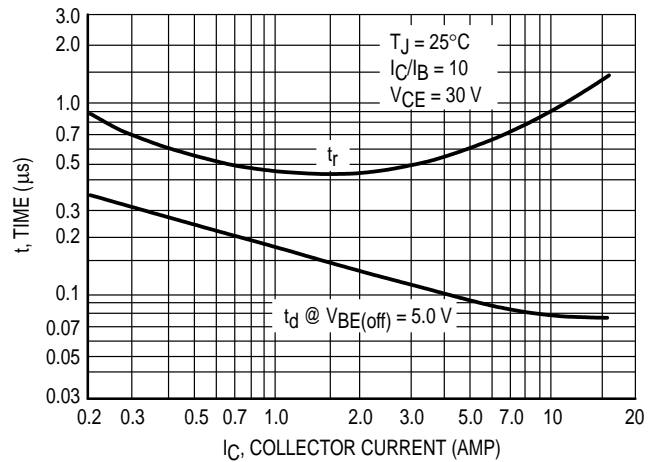

Figure 3. Typical Turn–On Time

TYPICAL CHARACTERISTICS

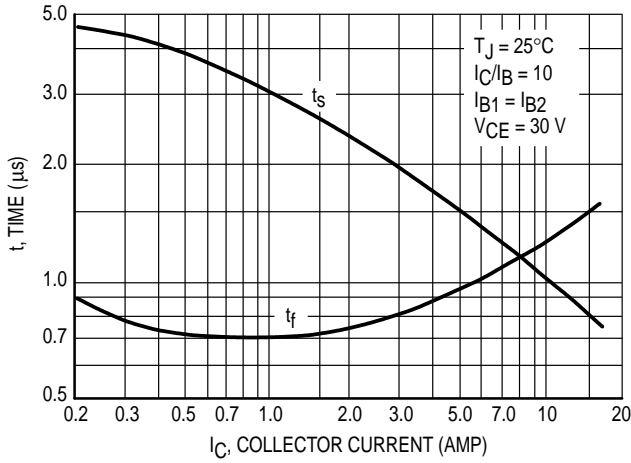

Figure 4. Turn-Off Time

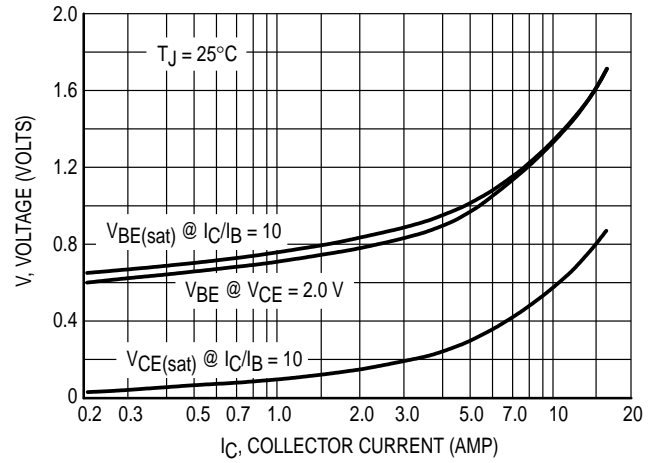

Figure 5. On Voltages

DC CURRENT GAIN

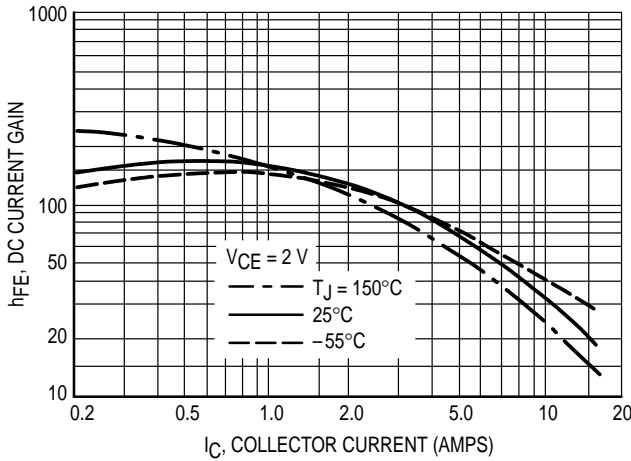

Figure 6. MJE4340 Series (NPN)

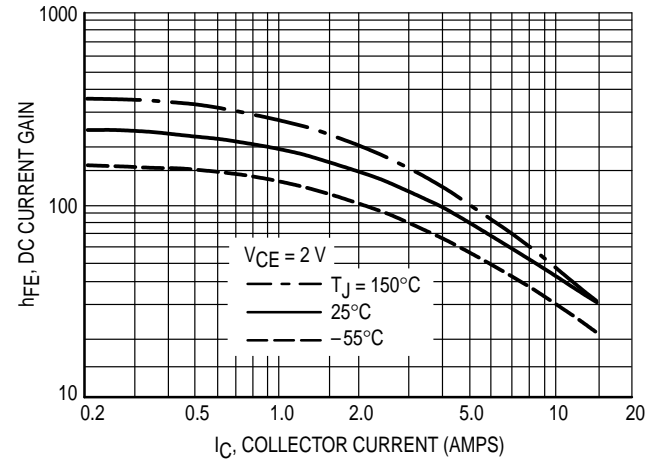

Figure 7. MJE4350 Series (PNP)

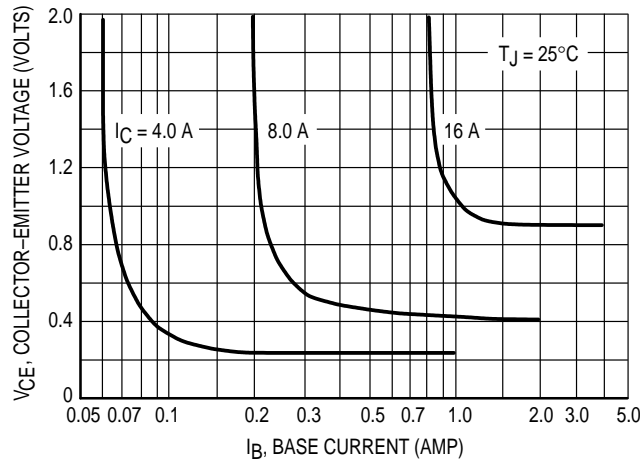

Figure 8. Collector Saturation Region

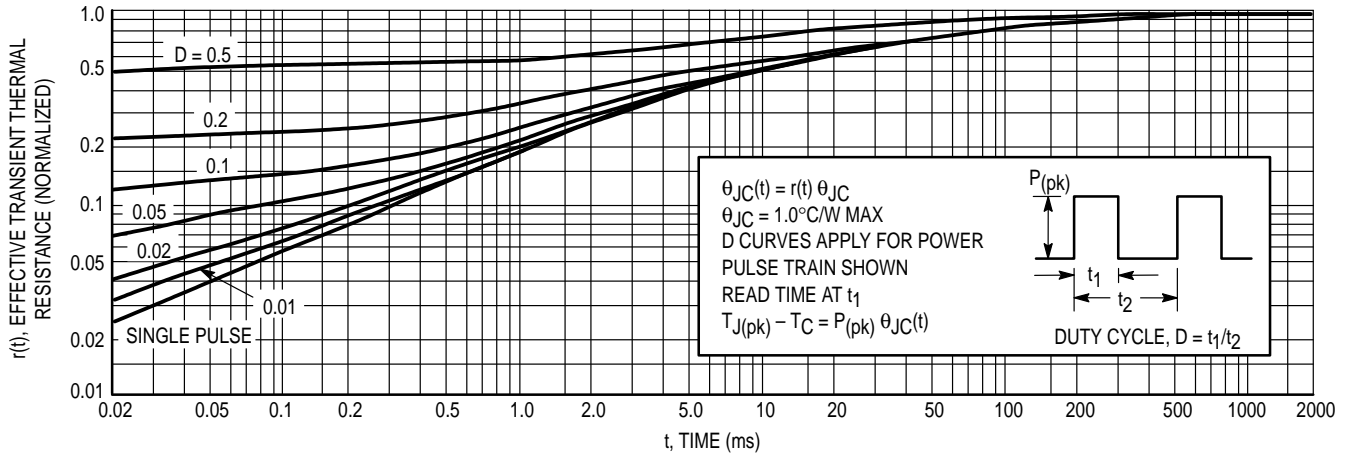

Figure 9. Thermal Response

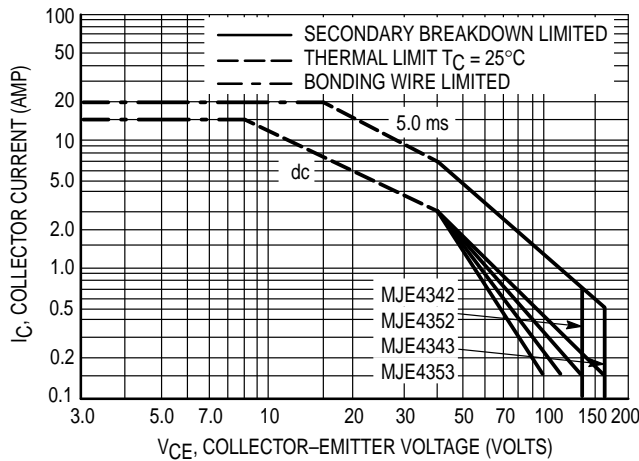

Figure 10. Maximum Forward Bias Safe Operating Area

REVERSE BIAS

For inductive loads, high voltage and high current must be sustained simultaneously during turn-off, in most cases, with the base to emitter junction reverse biased. Under these conditions the collector voltage must be held to a safe level at or below a specific value of collector current. This can be accomplished by several means such as active clamping, RC snubbing, load line shaping, etc. The safe level for these devices is specified as Reverse Bias Safe Operating Area and represents the voltage-current conditions during reverse biased turn-off. This rating is verified under clamped conditions so that the device is never subjected to an avalanche mode. Figure 11 gives RBSOA characteristics.

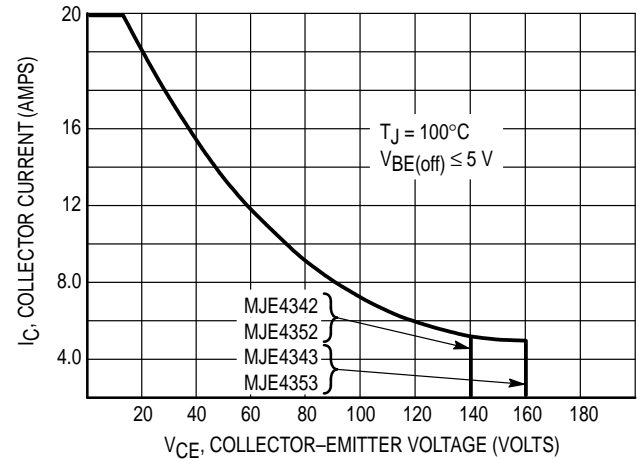
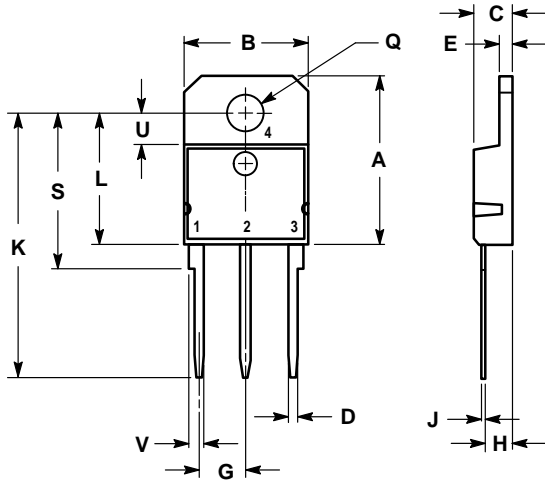

Figure 11. Maximum Reverse Bias Safe Operating Area

PACKAGE DIMENSIONS



NOTES:
 1. DIMENSIONING AND TOLERANCING PER ANSI Y14.5M, 1982.
 2. CONTROLLING DIMENSION: MILLIMETER.

DIM	MILLIMETERS		INCHES	
	MIN	MAX	MIN	MAX
A	19.00	19.60	0.749	0.771
B	14.00	14.50	0.551	0.570
C	4.20	4.70	0.165	0.185
D	1.00	1.30	0.040	0.051
E	1.45	1.65	0.058	0.064
G	5.21	5.72	0.206	0.225
H	2.60	3.00	0.103	0.118
J	0.40	0.60	0.016	0.023
K	28.50	32.00	1.123	1.259
L	14.70	15.30	0.579	0.602
Q	4.00	4.25	0.158	0.167
S	17.50	18.10	0.689	0.712
U	3.40	3.80	0.134	0.149
V	1.50	2.00	0.060	0.078

STYLE 1:
 PIN 1. BASE
 2. COLLECTOR
 3. EMITTER
 4. COLLECTOR

CASE 340D-01
 TO-218 TYPE
 ISSUE A

Motorola reserves the right to make changes without further notice to any products herein. Motorola makes no warranty, representation or guarantee regarding the suitability of its products for any particular purpose, nor does Motorola assume any liability arising out of the application or use of any product or circuit, and specifically disclaims any and all liability, including without limitation consequential or incidental damages. "Typical" parameters can and do vary in different applications. All operating parameters, including "Typicals" must be validated for each customer application by customer's technical experts. Motorola does not convey any license under its patent rights nor the rights of others. Motorola products are not designed, intended, or authorized for use as components in systems intended for surgical implant into the body, or other applications intended to support or sustain life, or for any other application in which the failure of the Motorola product could create a situation where personal injury or death may occur. Should Buyer purchase or use Motorola products for any such unintended or unauthorized application, Buyer shall indemnify and hold Motorola and its officers, employees, subsidiaries, affiliates, and distributors harmless against all claims, costs, damages, and expenses, and reasonable attorney fees arising out of, directly or indirectly, any claim of personal injury or death associated with such unintended or unauthorized use, even if such claim alleges that Motorola was negligent regarding the design or manufacture of the part. Motorola and  are registered trademarks of Motorola, Inc. Motorola, Inc. is an Equal Opportunity/Affirmative Action Employer.

How to reach us:

USA / EUROPE: Motorola Literature Distribution;
P.O. Box 20912; Phoenix, Arizona 85036. 1-800-441-2447

JAPAN: Nippon Motorola Ltd.; Tatsumi-SPD-JLDC, Toshikatsu Otsuki,
6F Seibu-Butsuryu-Center, 3-14-2 Tatsumi Koto-Ku, Tokyo 135, Japan. 03-3521-8315

MFAX: RMFAX0@email.sps.mot.com - TOUCHTONE (602) 244-6609
INTERNET: <http://Design-NET.com>

HONG KONG: Motorola Semiconductors H.K. Ltd.; 8B Tai Ping Industrial Park,
51 Ting Kok Road, Tai Po, N.T., Hong Kong. 852-26629298

