

# High-Voltage — High Power Transistors

... designed for use in high power audio amplifier applications and high voltage switching regulator circuits.

- High Collector–Emitter Sustaining Voltage —  
NPN PNP  
 $V_{CEO(sus)} = 160 \text{ Vdc} \text{ — MJE4343 MJE4353}$
- High DC Current Gain — @  $I_C = 8.0 \text{ Adc}$   
 $h_{FE} = 35 \text{ (Typ)}$
- Low Collector–Emitter Saturation Voltage —  
 $V_{CE(sat)} = 2.0 \text{ Vdc (Max) @ } I_C = 8.0 \text{ Adc}$

## MAXIMUM RATINGS

| Rating  | Symbol         | Max         | Unit             |
|---|----------------|-------------|------------------|
| Collector–Emitter Voltage                           | $V_{CEO}$      | 160         | Vdc              |
| Collector–Base Voltage                              | $V_{CB}$       | 160         | Vdc              |
| Emitter–Base Voltage                                | $V_{EB}$       | 7.0         | Vdc              |
| Collector Current — Continuous<br>Peak (1)          | $I_C$          | 16<br>20    | A dc             |
| Base Current — Continuous                           | $I_B$          | 5.0         | A dc             |
| Total Power Dissipation @ $T_C = 25^\circ\text{C}$  | $P_D$          | 125         | Watts            |
| Operating and Storage Junction<br>Temperature Range | $T_J, T_{stg}$ | -65 to +150 | $^\circ\text{C}$ |

## THERMAL CHARACTERISTICS

| Characteristic                       | Symbol          | Max | Unit               |
|--------------------------------------|-----------------|-----|--------------------|
| Thermal Resistance, Junction to Case | $R_{\theta JC}$ | 1.0 | $^\circ\text{C/W}$ |

(1) Pulse Test: Pulse Width  $\leq 5.0 \mu\text{s}$ , Duty Cycle  $\geq 10\%$ .

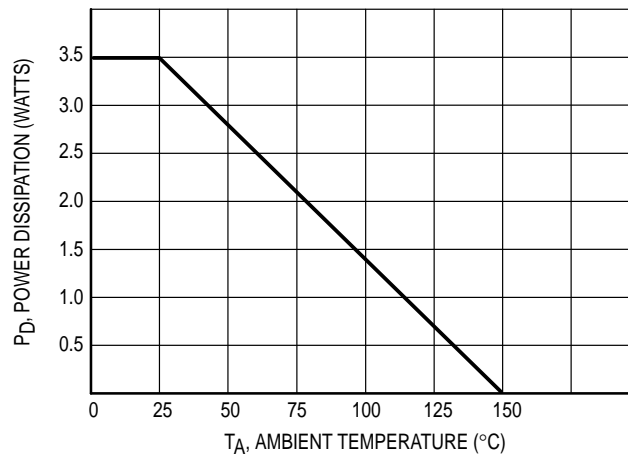

**Figure 1. Power Derating**  
Reference: Ambient Temperature

**NPN**  
**MJE4343**  
**PNP**  
**MJE4353**

**16 AMPERE**  
**POWER TRANSISTORS**  
**COMPLEMENTARY**  
**SILICON**  
**160 VOLTS**

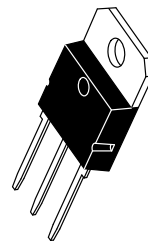

**CASE 340D-02**  
**TO-218 TYPE**

# MJE4343 MJE4353

## ELECTRICAL CHARACTERISTICS ( $T_C = 25^\circ\text{C}$ unless otherwise noted)

| Characteristic   | Symbol        | Min | Max        | Unit             |
|--|---------------|-----|------------|------------------|
| <b>OFF CHARACTERISTICS</b>   |               |     |            |                  |
| Collector–Emitter Sustaining Voltage (1)<br>( $I_C = 200\text{ mA}$ , $I_B = 0$ )  | $V_{CE(sus)}$ | 160 | —          | Vdc              |
| Collector–Emitter Cutoff Current<br>( $V_{CE} = 80\text{ Vdc}$ , $I_B = 0$ )   | $I_{CEO}$     | —   | 750        | $\mu\text{A}$ dc |
| Collector–Emitter Cutoff Current<br>( $V_{CE} = \text{Rated } V_{CB}$ , $V_{EB(off)} = 1.5\text{ Vdc}$ )<br>( $V_{CE} = \text{Rated } V_{CB}$ , $V_{EB(off)} = 1.5\text{ Vdc}$ , $T_C = 150^\circ\text{C}$ ) | $I_{CEX}$     | —   | 1.0<br>5.0 | $\text{mA}$ dc   |
| Collector–Base Cutoff Current<br>( $V_{CB} = \text{Rated } V_{CB}$ , $I_E = 0$ )   | $I_{CBO}$     | —   | 750        | $\mu\text{A}$ dc |
| Emitter–Base Cutoff Current<br>( $V_{BE} = 7.0\text{ Vdc}$ , $I_C = 0$ )   | $I_{EBO}$     | —   | 1.0        | $\text{mA}$ dc   |

## ON CHARACTERISTICS (1)

|  |               |           |                      |     |
|--|---------------|-----------|----------------------|-----|
| DC Current Gain<br>( $I_C = 8.0\text{ Adc}$ , $V_{CE} = 2.0\text{ Vdc}$ )<br>( $I_C = 16\text{ Adc}$ , $V_{CE} = 4.0\text{ Vdc}$ )               | $h_{FE}$      | 15<br>8.0 | 35 (Typ)<br>15 (Typ) | —   |
| Collector–Emitter Saturation Voltage<br>( $I_C = 8.0\text{ Adc}$ , $I_B = 800\text{ mA}$ )<br>( $I_C = 16\text{ Adc}$ , $I_B = 2.0\text{ Adc}$ ) | $V_{CE(sat)}$ | —<br>—    | 2.0<br>3.5           | Vdc |
| Base–Emitter Saturation Voltage<br>( $I_C = 16\text{ Adc}$ , $I_B = 2.0\text{ Adc}$ )  | $V_{BE(sat)}$ | —         | 3.9                  | Vdc |
| Base–Emitter On Voltage<br>( $I_C = 16\text{ Adc}$ , $V_{CE} = 4.0\text{ Vdc}$ )   | $V_{BE(on)}$  | —         | 3.9                  | Vdc |

## DYNAMIC CHARACTERISTICS

|   |          |     |     |     |
|---|----------|-----|-----|-----|
| Current–Gain — Bandwidth Product (2)<br>( $I_C = 1.0\text{ Adc}$ , $V_{CE} = 20\text{ Vdc}$ , $f_{test} = 0.5\text{ MHz}$ ) | $f_T$    | 1.0 | —   | MHz |
| Output Capacitance<br>( $V_{CB} = 10\text{ Vdc}$ , $I_E = 0$ , $f = 0.1\text{ MHz}$ )                                       | $C_{ob}$ | —   | 800 | pF  |

(1) Pulse Test: Pulse Width  $\leq 300\ \mu\text{s}$ , Duty Cycle  $\geq 2.0\%$ .

(2)  $f_T = |h_{fe}| \cdot f_{test}$ .

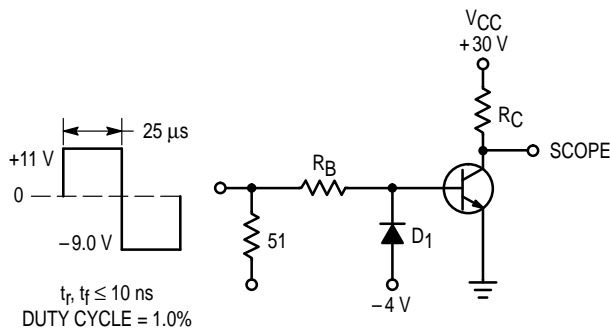

$R_B$  and  $R_C$  VARIED TO OBTAIN DESIRED CURRENT LEVELS

$D_1$  MUST BE FAST RECOVERY TYPE, e.g.:

1N5825 USED ABOVE  $I_B \approx 100\text{ mA}$

MSD6100 USED BELOW  $I_B \approx 100\text{ mA}$

**Note:** Reverse polarities to test PNP devices.

**Figure 2. Switching Times Test Circuit**

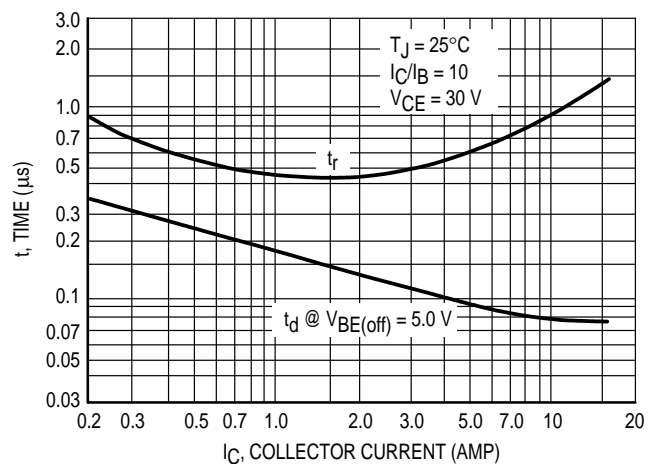

**Figure 3. Typical Turn–On Time**

TYPICAL CHARACTERISTICS

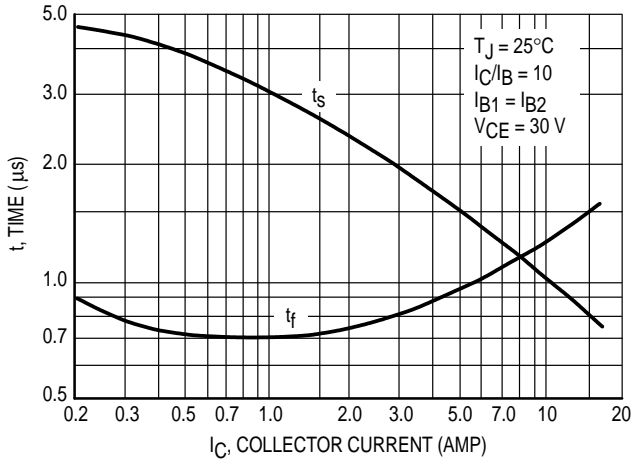

Figure 4. Turn-Off Time

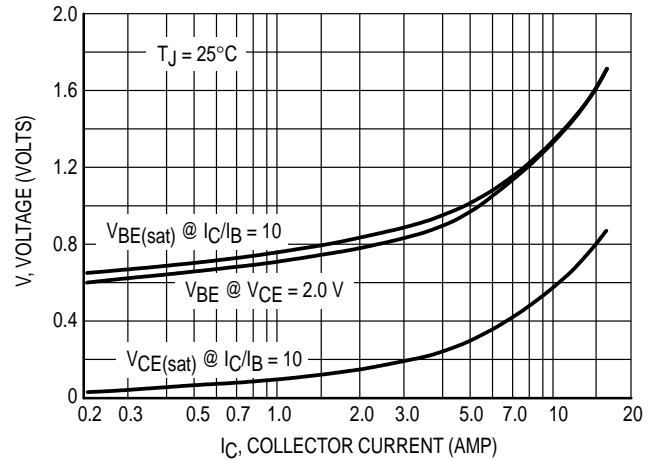

Figure 5. On Voltages

DC CURRENT GAIN

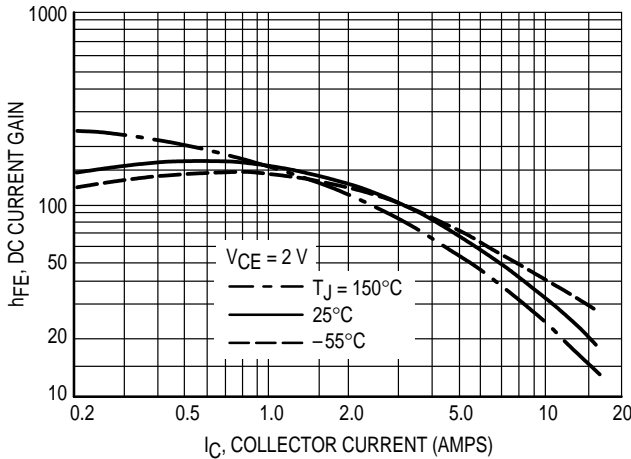

Figure 6. MJE4340 Series (NPN)

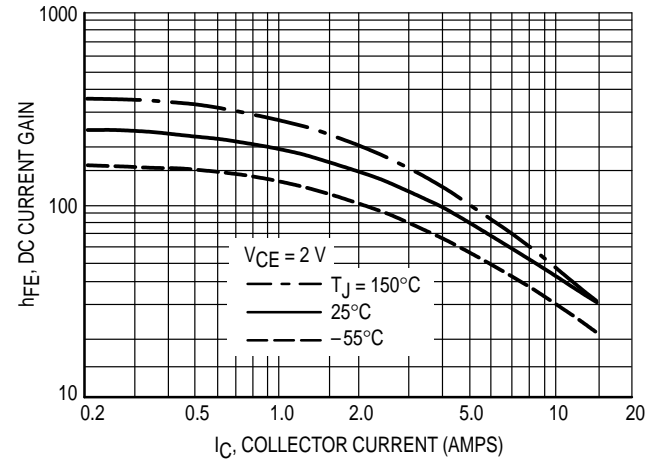

Figure 7. MJE4350 Series (PNP)

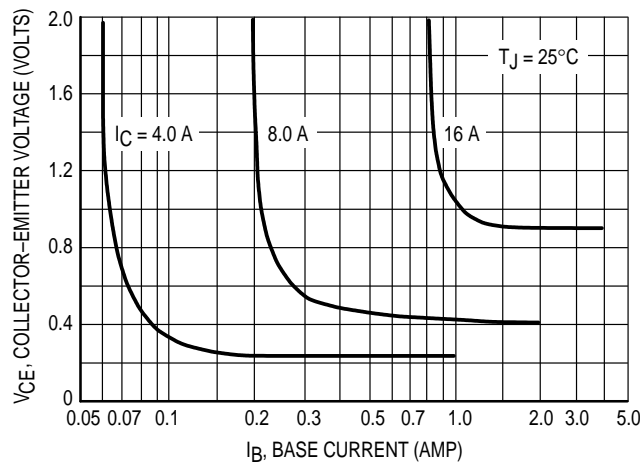

Figure 8. Collector Saturation Region

# MJE4343 MJE4353

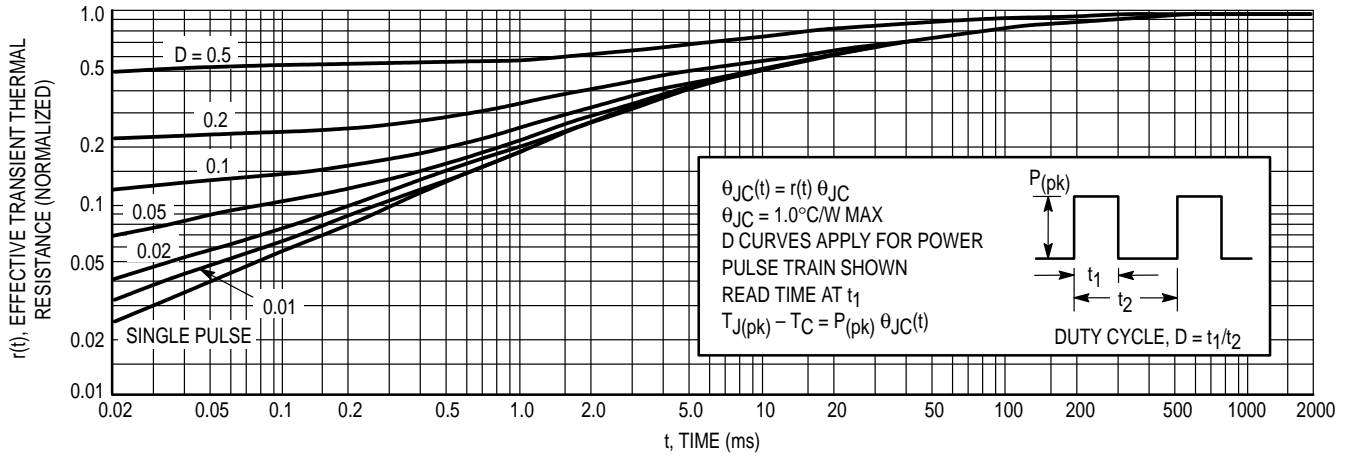

Figure 9. Thermal Response

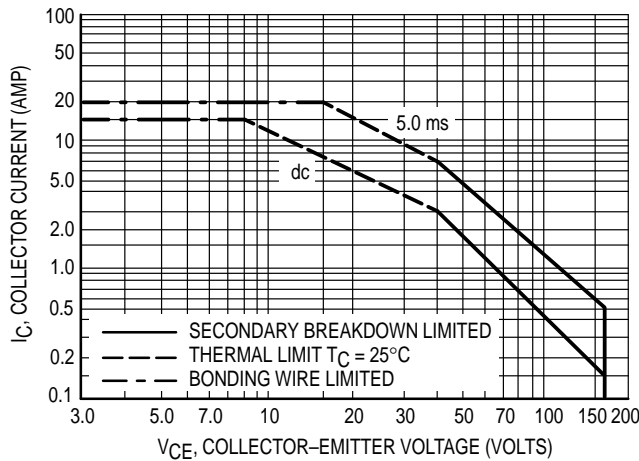

Figure 10. Maximum Forward Bias Safe Operating Area

## REVERSE BIAS

For inductive loads, high voltage and high current must be sustained simultaneously during turn-off, in most cases, with the base to emitter junction reverse biased. Under these conditions the collector voltage must be held to a safe level at or below a specific value of collector current. This can be accomplished by several means such as active clamping, RC snubbing, load line shaping, etc. The safe level for these devices is specified as Reverse Bias Safe Operating Area and represents the voltage-current conditions during reverse biased turn-off. This rating is verified under clamped conditions so that the device is never subjected to an avalanche mode. Figure 11 gives RBSOA characteristics.

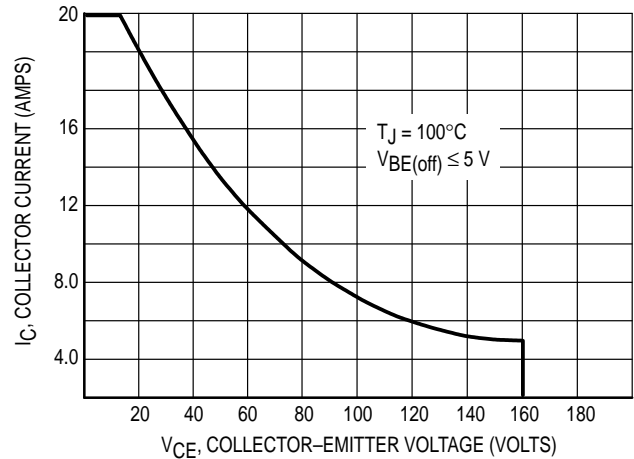
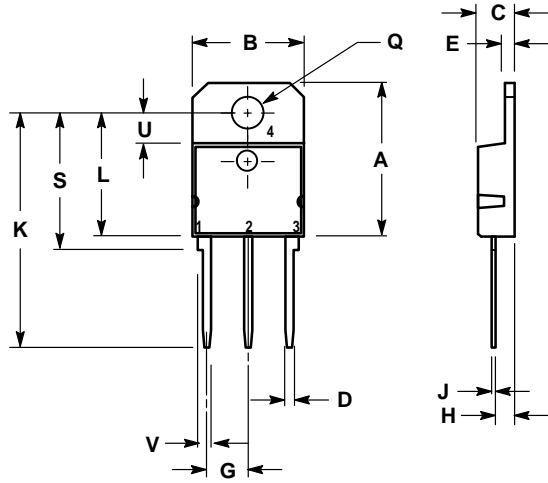

Figure 11. Maximum Reverse Bias Safe Operating Area

PACKAGE DIMENSIONS



- NOTES:  
 1. DIMENSIONING AND TOLERANCING PER ANSI Y14.5M, 1982.  
 2. CONTROLLING DIMENSION: MILLIMETER.

| DIM | MILLIMETERS |       | INCHES    |       |
|-----|-------------|-------|-----------|-------|
|     | MIN         | MAX   | MIN       | MAX   |
| A   | —           | 20.35 | —         | 0.801 |
| B   | 14.70       | 15.20 | 0.579     | 0.598 |
| C   | 4.70        | 4.90  | 0.185     | 0.193 |
| D   | 1.10        | 1.30  | 0.043     | 0.051 |
| E   | 1.17        | 1.37  | 0.046     | 0.054 |
| G   | 5.40        | 5.55  | 0.213     | 0.219 |
| H   | 2.00        | 3.00  | 0.079     | 0.118 |
| J   | 0.50        | 0.78  | 0.020     | 0.031 |
| K   | 31.00 REF   |       | 1.220 REF |       |
| L   | —           | 16.20 | —         | 0.638 |
| Q   | 4.00        | 4.10  | 0.158     | 0.161 |
| S   | 17.80       | 18.20 | 0.701     | 0.717 |
| U   | 4.00 REF    |       | 0.157 REF |       |
| V   | 1.75 REF    |       | 0.069     |       |

- STYLE 1:  
 PIN 1. BASE  
 2. COLLECTOR  
 3. EMITTER  
 4. COLLECTOR

CASE 340D-02  
 ISSUE B

Motorola reserves the right to make changes without further notice to any products herein. Motorola makes no warranty, representation or guarantee regarding the suitability of its products for any particular purpose, nor does Motorola assume any liability arising out of the application or use of any product or circuit, and specifically disclaims any and all liability, including without limitation consequential or incidental damages. "Typical" parameters which may be provided in Motorola data sheets and/or specifications can and do vary in different applications and actual performance may vary over time. All operating parameters, including "Typicals" must be validated for each customer application by customer's technical experts. Motorola does not convey any license under its patent rights nor the rights of others. Motorola products are not designed, intended, or authorized for use as components in systems intended for surgical implant into the body, or other applications intended to support or sustain life, or for any other application in which the failure of the Motorola product could create a situation where personal injury or death may occur. Should Buyer purchase or use Motorola products for any such unintended or unauthorized application, Buyer shall indemnify and hold Motorola and its officers, employees, subsidiaries, affiliates, and distributors harmless against all claims, costs, damages, and expenses, and reasonable attorney fees arising out of, directly or indirectly, any claim of personal injury or death associated with such unintended or unauthorized use, even if such claim alleges that Motorola was negligent regarding the design or manufacture of the part. Motorola and  are registered trademarks of Motorola, Inc. Motorola, Inc. is an Equal Opportunity/Affirmative Action Employer.

Mfax is a trademark of Motorola, Inc.

**How to reach us:**

**USA/EUROPE/Locations Not Listed:** Motorola Literature Distribution;  
P.O. Box 5405, Denver, Colorado 80217. 1-303-675-2140 or 1-800-441-2447

**JAPAN:** Nippon Motorola Ltd.; SPD, Strategic Planning Office, 141,  
4-32-1 Nishi-Gotanda, Shinagawa-ku, Tokyo, Japan. 81-3-5487-8488

**Customer Focus Center: 1-800-521-6274**

**Mfax™:** RMFAX0@email.sps.mot.com – TOUCHTONE 1-602-244-6609  
Motorola Fax Back System – US & Canada ONLY 1-800-774-1848  
– http://sps.motorola.com/mfax/

**ASIA/PACIFIC:** Motorola Semiconductors H.K. Ltd.; 8B Tai Ping Industrial Park,  
51 Ting Kok Road, Tai Po, N.T., Hong Kong. 852-26629298

**HOME PAGE:** <http://motorola.com/sps/>

