

# MJL21195, MJL21196

Preferred Device

## Silicon Power Transistors

The MJL21195 and MJL21196 utilize Perforated Emitter technology and are specifically designed for high power audio output, disk head positioners and linear applications.

- Total Harmonic Distortion Characterized
- High DC Current Gain –  $h_{FE} = 25 \text{ Min @ } I_C = 8 \text{ Adc}$
- Excellent Gain Linearity
- High SOA: 2.50 A, 80 V, 1 Second
- Epoxy Meets UL 94, V-0 @ 0.125 in
- ESD Ratings: Human Body Model, 3B > 8000 V  
Machine Model, C > 400 V
- Pb-Free Packages are Available\*

### MAXIMUM RATINGS

Rating	Symbol	Value	Unit
Collector-Emitter Voltage	$V_{CEO}$	250	Vdc
Collector-Base Voltage	$V_{CBO}$	400	Vdc
Emitter-Base Voltage	$V_{EBO}$	5	Vdc
Collector-Emitter Voltage – 1.5 V	$V_{CEX}$	400	Vdc
Collector Current – Continuous Peak (Note 1)	$I_C$	16 30	Adc
Base Current – Continuous	$I_B$	5	Adc
Total Power Dissipation @ $T_C = 25^\circ\text{C}$ Derate Above $25^\circ\text{C}$	$P_D$	200 1.43	W W/ $^\circ\text{C}$
Operating and Storage Junction Temperature Range	$T_J, T_{stg}$	- 65 to +150	$^\circ\text{C}$

### THERMAL CHARACTERISTICS

Characteristic	Symbol	Max	Unit
Thermal Resistance, Junction-to-Case	$R_{\theta JC}$	0.7	$^\circ\text{C}/\text{W}$

Maximum ratings are those values beyond which device damage can occur. Maximum ratings applied to the device are individual stress limit values (not normal operating conditions) and are not valid simultaneously. If these limits are exceeded, device functional operation is not implied, damage may occur and reliability may be affected.

1. Pulse Test: Pulse Width = 5.0  $\mu\text{s}$ , Duty Cycle  $\leq 10\%$ .

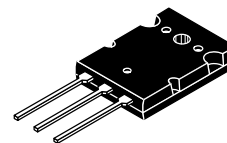


ON Semiconductor®

<http://onsemi.com>

## 16 A COMPLEMENTARY SILICON POWER TRANSISTORS 250 V, 200 W

### MARKING DIAGRAM



TO-264  
CASE 340G  
STYLE 2



xxxx = 21195 or 21196  
A = Assembly Location  
WL, L = Wafer Lot  
YY, Y = Year  
WW, W = Work Week  
G = Pb-Free Package

### ORDERING INFORMATION

See detailed ordering and shipping information in the package dimensions section on page 6 of this data sheet.

\*For additional information on our Pb-Free strategy and soldering details, please download the ON Semiconductor Soldering and Mounting Techniques Reference Manual, SOLDERRM/D.

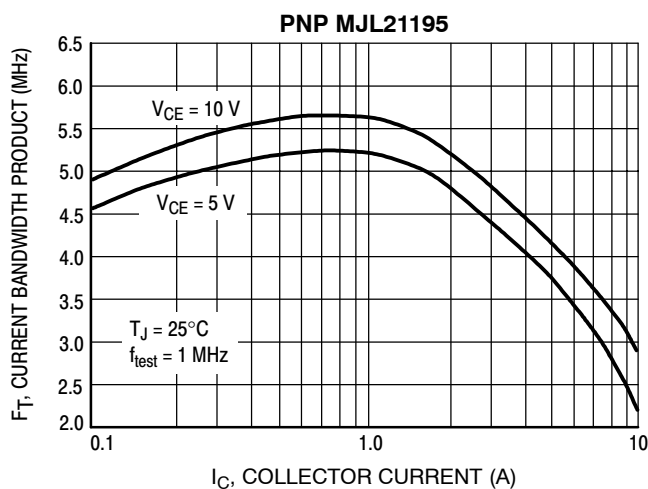
Preferred devices are recommended choices for future use and best overall value.

# MJL21195, MJL21196

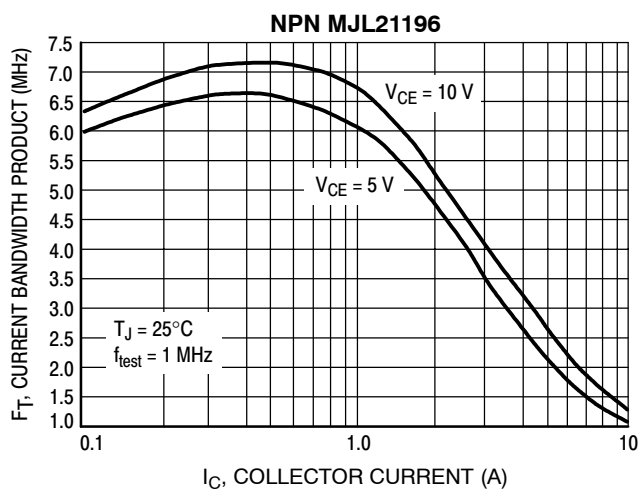
## ELECTRICAL CHARACTERISTICS ( $T_C = 25^\circ\text{C}$ unless otherwise noted)

Characteristic	Symbol	Min	Typical	Max	Unit
<b>OFF CHARACTERISTICS (Note 2)</b>					
Collector-Emitter Sustaining Voltage ( $I_C = 100\text{ mA}$ , $I_B = 0$ )	$V_{CE(sus)}$	250	-	-	Vdc
Collector Cutoff Current ( $V_{CE} = 200\text{ Vdc}$ , $I_B = 0$ )	$I_{CEO}$	-	-	100	$\mu\text{A}$
<b>OFF CHARACTERISTICS (Note 3)</b>					
Emitter Cutoff Current ( $V_{CE} = 5\text{ Vdc}$ , $I_C = 0$ )	$I_{EBO}$	-	-	100	$\mu\text{A}$
Collector Cutoff Current ( $V_{CE} = 250\text{ Vdc}$ , $V_{BE(off)} = 1.5\text{ Vdc}$ )	$I_{CEX}$	-	-	100	$\mu\text{A}$
<b>SECOND BREAKDOWN (Note 3)</b>					
Second Breakdown Collector Current with Base Forward Biased ( $V_{CE} = 50\text{ Vdc}$ , $t = 1\text{ s}$ (Nonrepetitive)) ( $V_{CE} = 80\text{ Vdc}$ , $t = 1\text{ s}$ (Nonrepetitive))	$I_{S/b}$	4.0 2.25	- -	- -	A
<b>ON CHARACTERISTICS (Note 3)</b>					
DC Current Gain ( $I_C = 8\text{ A}$ , $V_{CE} = 5\text{ Vdc}$ ) ( $I_C = 16\text{ A}$ , $I_B = 5\text{ A}$ )	$h_{FE}$	25 8.0	- -	100 -	
Base-Emitter On Voltage ( $I_C = 8\text{ A}$ , $V_{CE} = 5\text{ Vdc}$ )	$V_{BE(on)}$	-	-	2.2	Vdc
Collector-Emitter Saturation Voltage ( $I_C = 8\text{ A}$ , $I_B = 0.8\text{ A}$ ) ( $I_C = 16\text{ A}$ , $I_B = 3.2\text{ A}$ )	$V_{CE(sat)}$	- -	- -	1.4 4	Vdc
<b>DYNAMIC CHARACTERISTICS (Note 3)</b>					
Total Harmonic Distortion at the Output $V_{RMS} = 28.3\text{ V}$ , $f = 1\text{ kHz}$ , $P_{LOAD} = 100\text{ W}_{RMS}$ (Matched pair $h_{FE} = 50 @ 5\text{ A}/5\text{ V}$ )	$T_{HD}$	- -	0.8 0.08	- -	%
Current Gain Bandwidth Product ( $I_C = 1\text{ A}$ , $V_{CE} = 10\text{ Vdc}$ , $f_{test} = 1\text{ MHz}$ )	$f_T$	4	-	-	MHz
Output Capacitance ( $V_{CB} = 10\text{ Vdc}$ , $I_E = 0$ , $f_{test} = 1\text{ MHz}$ )	$C_{ob}$	-	-	500	pF

2. Pulse Test: Pulse Width = 5.0  $\mu\text{s}$ , Duty Cycle  $\leq 10\%$ .
3. Pulse Test: Pulse Width = 300  $\mu\text{s}$ , Duty Cycle  $\leq 2\%$ .



**Figure 1. Typical Current Gain Bandwidth Product**



**Figure 2. Typical Current Gain Bandwidth Product**

# MJL21195, MJL21196

## TYPICAL CHARACTERISTICS

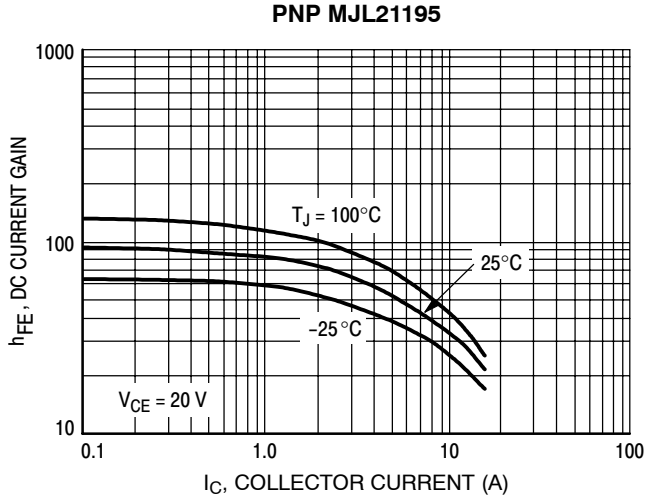


Figure 3. DC Current Gain,  $V_{CE} = 20$  V

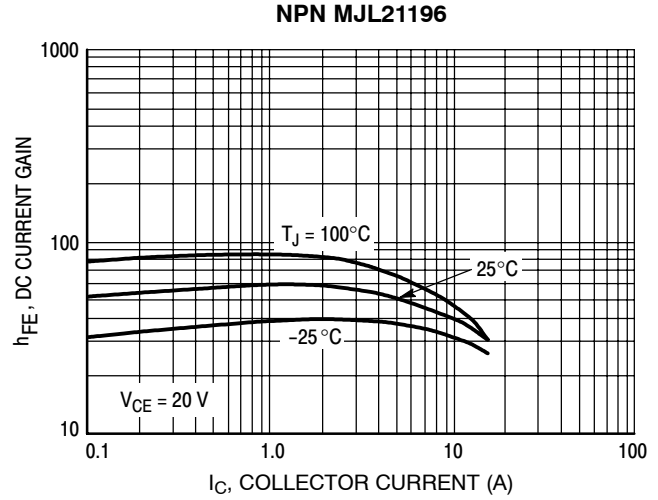


Figure 4. DC Current Gain,  $V_{CE} = 20$  V

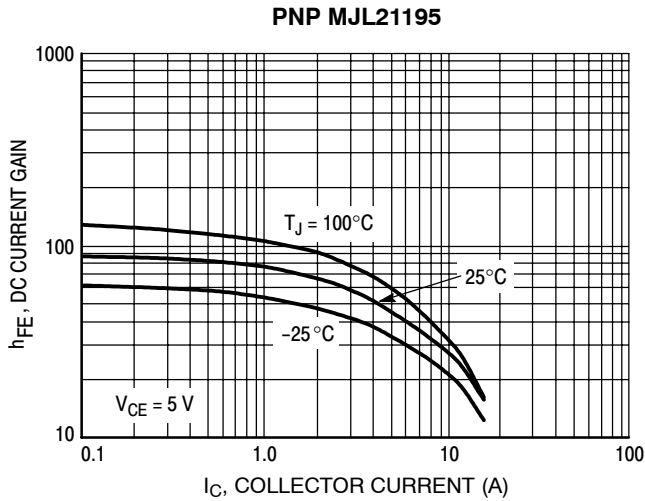


Figure 5. DC Current Gain,  $V_{CE} = 5$  V

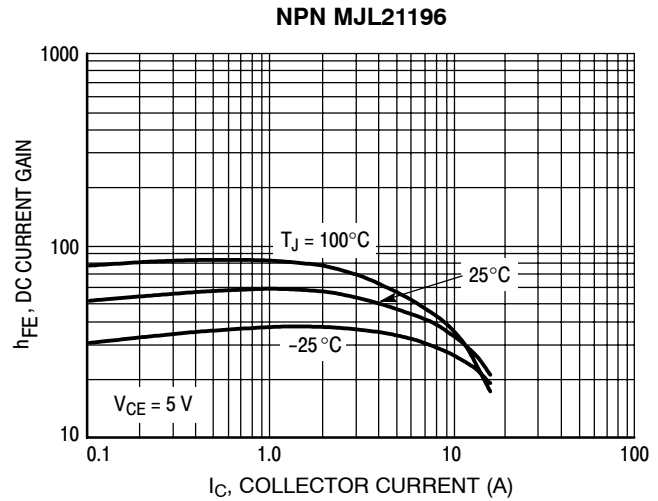


Figure 6. DC Current Gain,  $V_{CE} = 5$  V

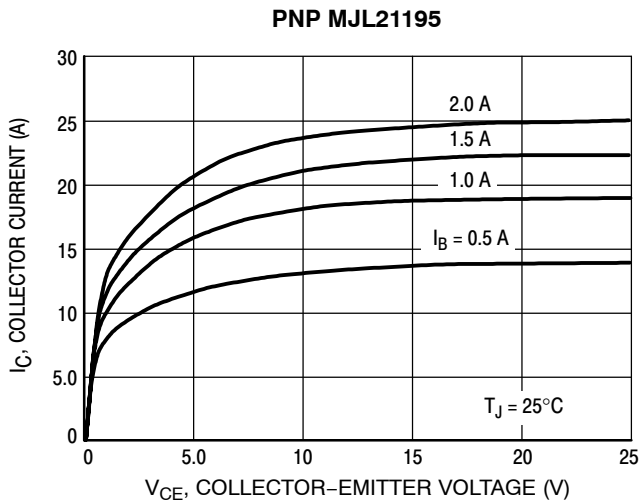


Figure 7. Typical Output Characteristics

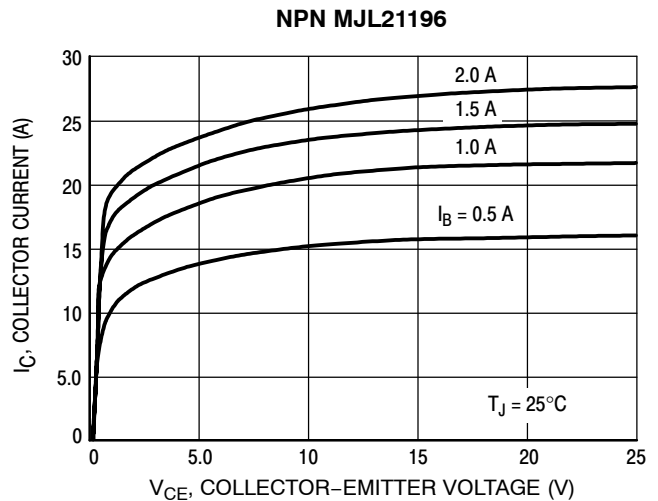
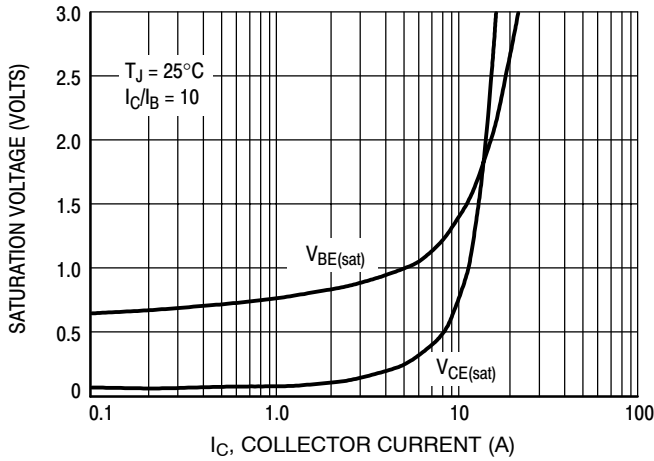


Figure 8. Typical Output Characteristics

# MJL21195, MJL21196

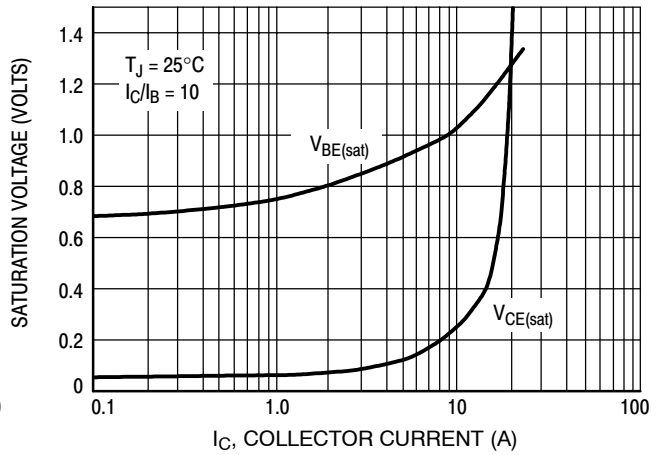
## TYPICAL CHARACTERISTICS

**PNP MJL21195**



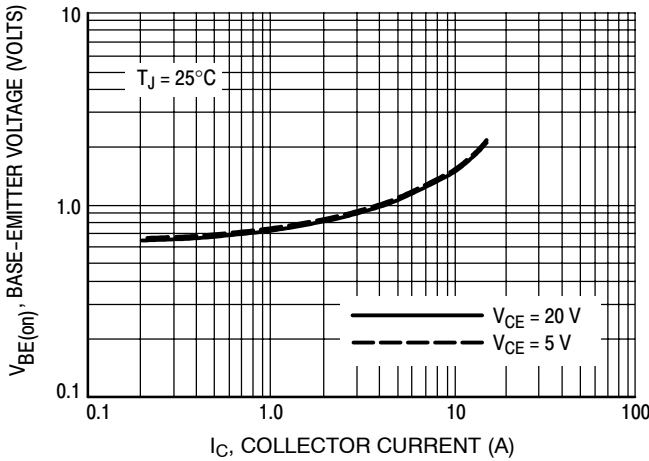
**Figure 9. Typical Saturation Voltages**

**NPN MJL21196**



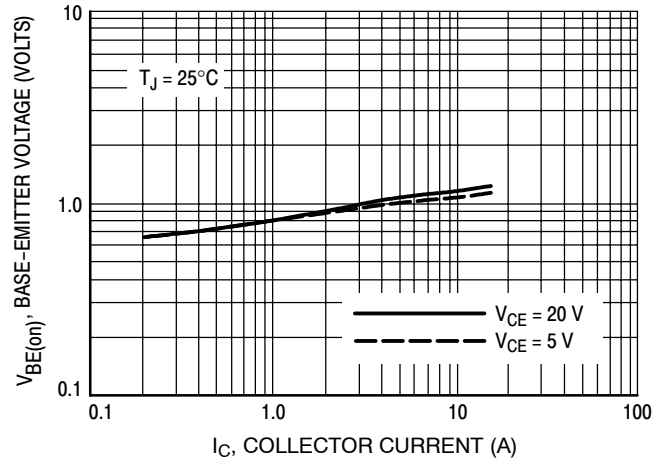
**Figure 10. Typical Saturation Voltages**

**PNP MJL21195**

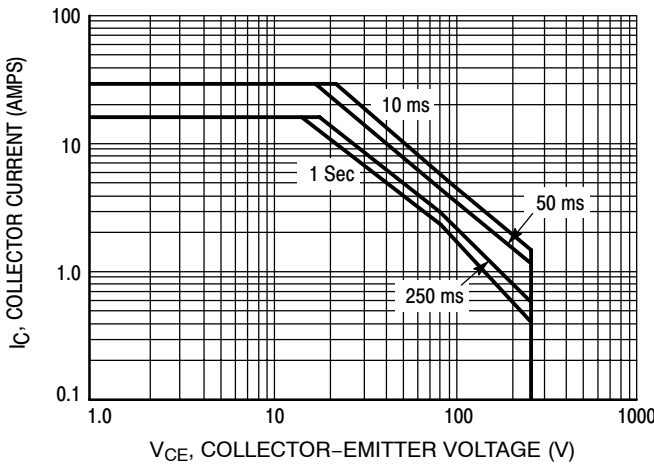


**Figure 11. Typical Base-Emitter Voltage**

**NPN MJL21196**



**Figure 12. Typical Base-Emitter Voltage**



**Figure 13. Active Region Safe Operating Area**

There are two limitations on the power handling ability of a transistor; average junction temperature and secondary breakdown. Safe operating area curves indicate  $I_C - V_{CE}$  limits of the transistor that must be observed for reliable operation; i.e., the transistor must not be subjected to greater dissipation than the curves indicate.

The data of Figure 13 is based on  $T_{J(pk)} = 150^\circ\text{C}$ ;  $T_C$  is variable depending on conditions. At high case temperatures, thermal limitations will reduce the power than can be handled to values less than the limitations imposed by second breakdown.

# MJL21195, MJL21196

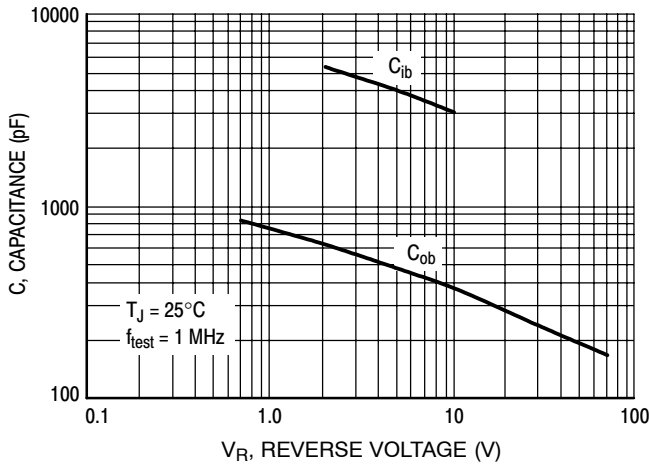


Figure 14. MJL21195 Typical Capacitance

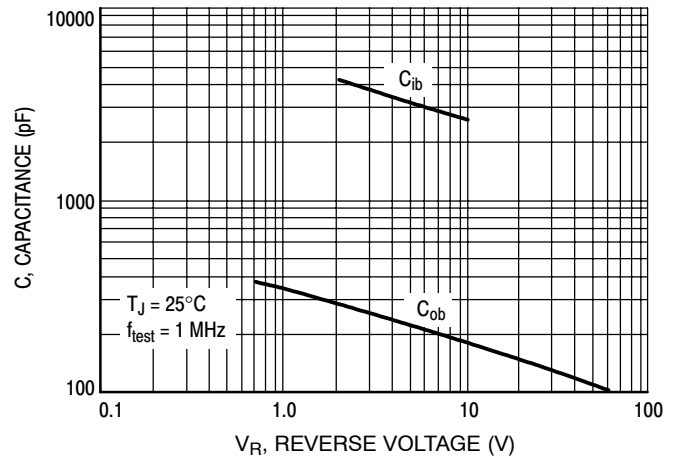


Figure 15. MJL21196 Typical Capacitance

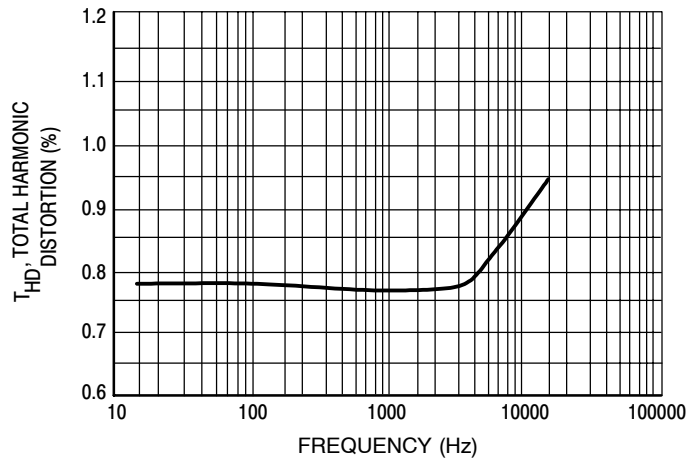


Figure 16. Typical Total Harmonic Distortion

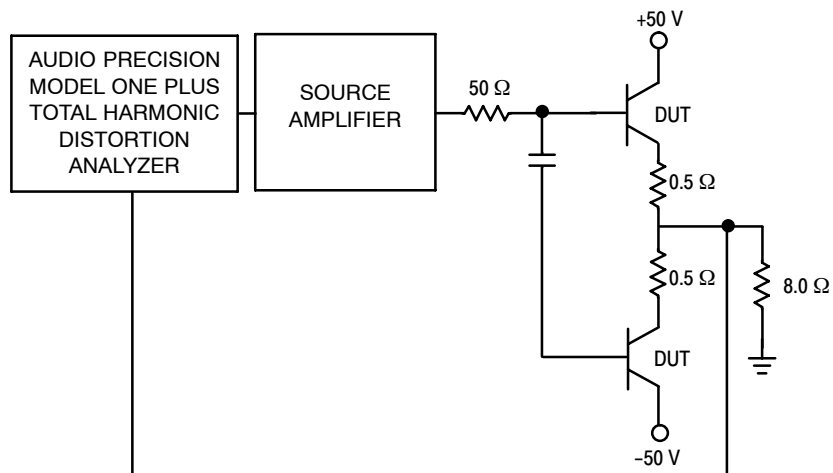


Figure 17. Total Harmonic Distortion Test Circuit

## MJL21195, MJL21196

### ORDERING INFORMATION

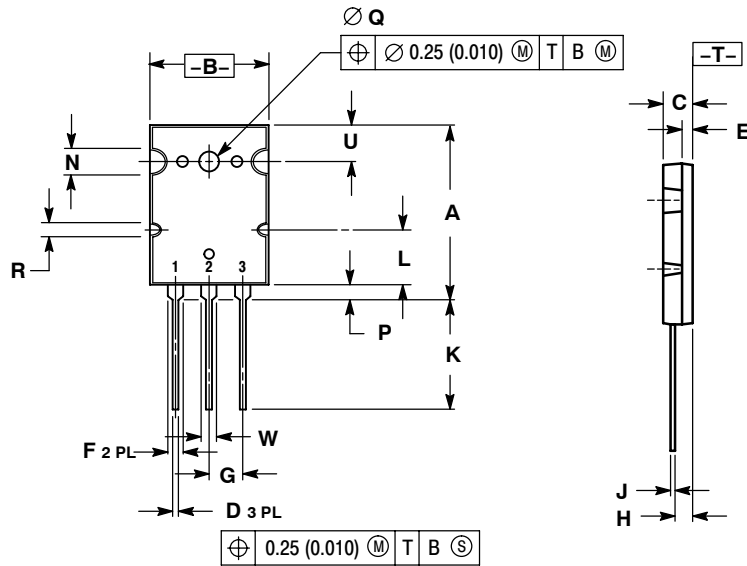
Device	Package	Shipping†
MJL21195	TO-264	25 Units / Rail
MJL21195G	TO-264 (Pb-Free)	25 Units / Rail
MJL21196	TO-264	25 Units / Rail
MJL21196G	TO-264 (Pb-Free)	25 Units / Rail

†For information on tape and reel specifications, including part orientation and tape sizes, please refer to our Tape and Reel Packaging Specifications Brochure, BRD8011/D.

# MJL21195, MJL21196

## PACKAGE DIMENSIONS

TO-3BPL (TO-264)  
CASE 340G-02  
ISSUE J



- NOTES:  
1. DIMENSIONING AND TOLERANCING PER ANSI Y14.5M, 1982.  
2. CONTROLLING DIMENSION: MILLIMETER.

DIM	MILLIMETERS		INCHES	
	MIN	MAX	MIN	MAX
A	28.0	29.0	1.102	1.142
B	19.3	20.3	0.760	0.800
C	4.7	5.3	0.185	0.209
D	0.93	1.48	0.037	0.058
E	1.9	2.1	0.075	0.083
F	2.2	2.4	0.087	0.102
G	5.45 BSC		0.215 BSC	
H	2.6	3.0	0.102	0.118
J	0.43	0.78	0.017	0.031
K	17.6	18.8	0.693	0.740
L	11.2 REF		0.411 REF	
N	4.35 REF		0.172 REF	
P	2.2	2.6	0.087	0.102
Q	3.1	3.5	0.122	0.137
R	2.25 REF		0.089 REF	
U	6.3 REF		0.248 REF	
W	2.8	3.2	0.110	0.125

- STYLE 2:  
PIN 1. BASE  
2. COLLECTOR  
3. EMITTER

**ON Semiconductor** and **ON** are registered trademarks of Semiconductor Components Industries, LLC (SCILLC). SCILLC reserves the right to make changes without further notice to any products herein. SCILLC makes no warranty, representation or guarantee regarding the suitability of its products for any particular purpose, nor does SCILLC assume any liability arising out of the application or use of any product or circuit, and specifically disclaims any and all liability, including without limitation special, consequential or incidental damages. "Typical" parameters which may be provided in SCILLC data sheets and/or specifications can and do vary in different applications and actual performance may vary over time. All operating parameters, including "Typicals" must be validated for each customer application by customer's technical experts. SCILLC does not convey any license under its patent rights nor the rights of others. SCILLC products are not designed, intended, or authorized for use as components in systems intended for surgical implant into the body, or other applications intended to support or sustain life, or for any other application in which the failure of the SCILLC product could create a situation where personal injury or death may occur. Should Buyer purchase or use SCILLC products for any such unintended or unauthorized application, Buyer shall indemnify and hold SCILLC and its officers, employees, subsidiaries, affiliates, and distributors harmless against all claims, costs, damages, and expenses, and reasonable attorney fees arising out of, directly or indirectly, any claim of personal injury or death associated with such unintended or unauthorized use, even if such claim alleges that SCILLC was negligent regarding the design or manufacture of the part. SCILLC is an Equal Opportunity/Affirmative Action Employer. This literature is subject to all applicable copyright laws and is not for resale in any manner.

#### PUBLICATION ORDERING INFORMATION

**LITERATURE FULFILLMENT:**

Literature Distribution Center for ON Semiconductor  
P.O. Box 61312, Phoenix, Arizona 85082-1312 USA  
**Phone:** 480-829-7710 or 800-344-3860 Toll Free USA/Canada  
**Fax:** 480-829-7709 or 800-344-3867 Toll Free USA/Canada  
**Email:** [orderlit@onsemi.com](mailto:orderlit@onsemi.com)

**N. American Technical Support:** 800-282-9855 Toll Free  
USA/Canada

**Japan:** ON Semiconductor, Japan Customer Focus Center  
2-9-1 Kamimeguro, Meguro-ku, Tokyo, Japan 153-0051  
**Phone:** 81-3-5773-3850

**ON Semiconductor Website:** <http://onsemi.com>

**Order Literature:** <http://www.onsemi.com/litorder>

For additional information, please contact your  
local Sales Representative.