



General Purpose Relay

MK

- Exceptionally reliable general purpose relay
- Long life (minimum 100,000 electrical operations) assured by silver contacts
- Built-in operation indicator (mechanical, LED), diode surge suppression, Varistor surge suppression
- The contact operation can be easily checked by mechanical indicator and/or push-to-test button options
- Conforms to CENELEC standards
- VDE approved versions available



Ordering Information

To Order: Select the part number and add the desired coil voltage rating (e.g., MK3P5-S-AC120).

| Type | Terminal | Coil | Contact form | Part number | |
|----------------------------|----------|-------|-------------------|----------------------|--------------------------------------------|
| | | | | Mechanical indicator | Mechanical indicator & push-to-test button |
| Standard | Plug-in | AC/DC | DPDT | MK2P-I | MK2P-S |
| | | | 3PDT | MK3P-5-I | MK3P-5-S |
| LED indicator | | | DPDT | MK2PN-I | MK2PN-S |
| | | | 3PDT | MK3PN-5-I | MK3PN-5-S |
| LED indicator and diode | | DC | DPDT | MK2PND-I | MK2PND-S |
| | | | 3PDT | MK3PND-5-I | MK3PND-5-S |
| LED indicator and varistor | AC | DPDT | MK2PNV-I | MK2PNV-S | |
| | | 3PDT | MK3PNV-5-I | MK3PNV-5-S | |
| Diode | DC | DPDT | MK2PD-I | MK2PD-S | |
| | | 3PDT | MK3PD-5-I | MK3PD-5-S | |
| Varistor | AC | DPDT | MK2PV-I | MK2PV-S | |
| | | 3PDT | MK3PV-5-I | MK3PV-5-S | |

Note: 1. Reverse polarity versions available on DC coil types. Consult your OMRON representative for further information.
 2. VDE approved versions are available. Consult your OMRON representative for further information.

■ ACCESSORIES (Order separately)

To Order: Select the appropriate part numbers for sockets, clips, and mounting tracks (if required) from the available types chart.

Track mounted sockets

| Relay type | Part number | | |
|--------------|-----------------|----------------------|----------------------------------------------------------------|
| | Socket | Relay hold-down clip | Mounting track/end plate |
| SPDT DPDT | PF083A-E | PFC-A1 | PFP-100N or PFP-50N and PFP-M (end plate) |
| 3PDT | PF113A-E | PFC-A1 | PFP-100N or PFP-50N and PFP-M (end plate) |

■ ACCESSORIES (continued)

Back connecting sockets

| Relay type | Part number | |
|------------|----------------|----------------------|
| | Socket | Relay hold-down clip |
| SPDT | PL08 | PLC-E |
| DPDT | PLE08-0 | PLC-10 |
| | PL08-Q | PLC-E |
| 3PDT | PL11 | PLC-E |
| | PLE11-0 | PLC-10 |
| | PL11-Q | PLC-E |

Specifications

■ CONTACT DATA

| Load | Resistive load (p.f. = 1) | | Inductive load (p.f. = 0.4) |
|-------------------------|-----------------------------------|------------------------------------------------------|-----------------------------|
| | 2 Pole | 3 Pole | |
| Rated load | 10 A at 250 VAC 10 A at 28 VDC | 10 A at 120 VAC 10 A at 28 VDC 10 A at 250 VAC | 7 A at 250 VAC |
| Contact material | Ag | | |
| Carry current | 10 A | | |
| Max. operating voltage | 250 VAC, 250 VDC | | |
| Max. operating current | 10 A | | |
| Max. switching capacity | 2,500 VA 280 W | 2,500 VA/1,250 VA (NO/NC contacts) 280 W | 1,750 VA |
| Min. permissible load | 10 mA at 1 VDC | | |

COIL DATA ■

AC

| Rated voltage (VAC) | Rated current (mA) (at 60 Hz) | Coil resistance (Ω) | Coil inductance (Ref. value) (H) | | Pick-up voltage | Dropout voltage | Maximum voltage | Power consumption (mW) |
|---------------------|-------------------------------|---------------------|----------------------------------|-------------|-------------------------------|--------------------------------------------------|-----------------|--------------------------------------------------------------------|
| | | | Armature OFF | Armature ON | | | | |
| 6 | 360 | 3.9 | 0.0423 | 0.0201 | 80% max. Approx. 2.7 VA | 30% min. (at 60 Hz) 25% min. (at 50 Hz) | 110% max. | Approx. 2.3 VA (at 60 Hz) Approx. 2.7 VA (at 50 Hz) |
| 12 | 180 | 16.3 | 0.3270 | 0.1666 | | | | |
| 24 | 88.0 | 68.0 | 0.6940 | 0.3760 | | | | |
| 50 | 39.0 | 338 | 3.195 | 1.530 | | | | |
| 110 | 21.0 | 1240 | 13.45 | 7.32 | | | | |
| 120 | 18.0 | 1578 | 15.04 | 7.19 | | | | |
| 220 | 11.0 | 5090 | 49.73 | 27.02 | | | | |
| 240 | 9.2 | 6737 | 58.62 | 32.07 | | | | |

DC

| Rated voltage (VDC) | Rated current (mA) (at 60 Hz) | Coil resistance (Ω) | Coil inductance (Ref. value) (H) | | Pick-up voltage | Dropout voltage | Maximum voltage | Power consumption (mW) |
|---------------------|-------------------------------|---------------------|----------------------------------|-------------|-------------------------------|-----------------|-----------------|------------------------|
| | | | Armature OFF | Armature ON | | | | |
| 6 | 255 | 23.5 | 0.206 | 0.106 | 80% max. Approx. 2.7 VA | 15% min. | 110% max. | Approx. 1.5 W |
| 12 | 126 | 95 | 0.963 | 0.449 | | | | |
| 24 | 56 | 430 | 4.915 | 2.478 | | | | |
| 48 | 29.5 | 1630 | 16.685 | 10.487 | | | | |
| 110 | 15.1 | 7300 | 80.2 | 42.6 | | | | |

- Note:
1. The rated current and coil resistance are measured at a coil temperature of 23°C (73°F) with a tolerance of ±15% for DC rated current and +15%, -20% for AC rated current.
 2. The rated current is reference value.
 3. Performance characteristic data are measured at a coil temperature of 23°C (73°F).
 4. For models with the LED indicator built-in, add an LED current of approximately 0 thru 5 mA to the rated current.

■ CHARACTERISTICS

| | | |
|-----------------------|------------------------|---------------------------------------------------------------------------------------------------------------------------------------------------------------------------------------------------------------------------------------------------------------------------------------------------------|
| Contact resistance | | 50 mΩ max. |
| Operate time | | AC: 20 ms max. DC: 30 ms max. |
| Release time | | 20 ms max. |
| Operating frequency | Mechanical | 18,000 operations/hour |
| | Electrical | 1,800 operations/hour (under rated load) |
| Insulation resistance | | 100 MΩ min. (at 500 VDC) |
| Dielectric strength | | 2,500 VAC, 50/60 Hz for 1 minute between coil and contacts 1,000 VAC, 50/60 Hz for 1 minute between contacts of same poles, between terminals of the same polarity 2,500 VAC, 50/60 Hz for 1 minute between current-carrying parts, noncurrent-carrying parts, and terminals of opposite polarity |
| Vibration | Mechanical durability | 10 to 55 Hz, 1.50 mm (0.06 in) double amplitude |
| | Malfunction durability | 10 to 55 Hz, 1.00 mm (0.04 in) double amplitude |
| Shock | Mechanical durability | 1,000 m/s ² (approx. 100 G) |
| | Malfunction durability | 100 m/s ² (approx. 10 G) |
| Ambient temperature | | Operation: -10° to 40°C (14° to 104°F) |
| Humidity | | 35 to 85% RH |
| Service Life | Mechanical | 10 million operations min. (at operating frequency of 18,000 operations/hour) |
| | Electrical | 100,000 operations at rated load (at operating frequency of 1,800 operations/hour) |
| Weight | | Approx. 0.85 g (3.0 oz) |

Note: Data shown are of initial value.

■ CHARACTERISTIC DATA

Maximum switching capacity MK2P-S, MK3P5-S

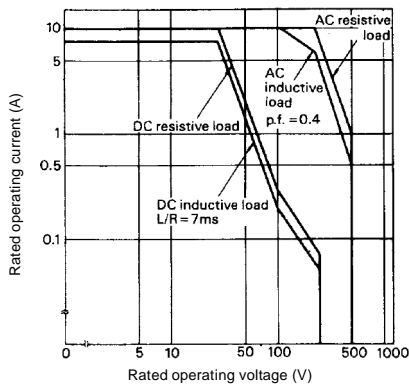

Electrical service life MK2P-S, MK3P5-S

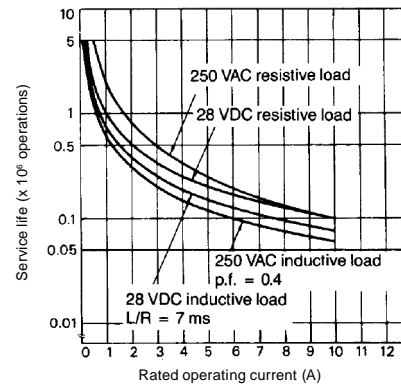

Dimensions

Unit: mm (inch)

RELAYS

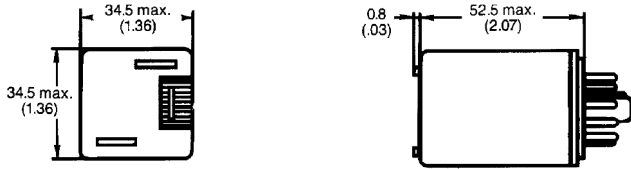

TERMINAL ARRANGEMENT (Bottom view)

Standard type (AC/DC coil)
MK2P-I, -S

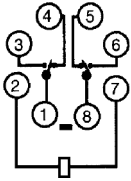

MK3P5-I, -S

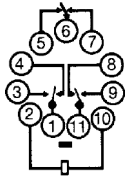

LED indicator type (AC coil)
MK2PN-I, -S

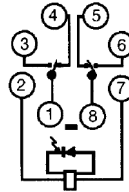

MK3PN-5-I, -S

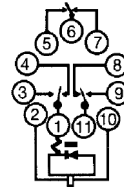

LED indicator type (DC coil)
MK2PN-I, -S

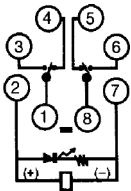

MK3PN-5-I, -S

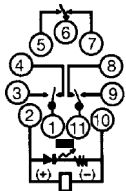

Diode type (DC coil)
MK2PD-I, -S

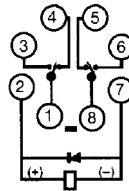

MK3PD-5-I, -S

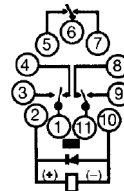

Varistor type (AC coil)
MK2PV-I, -S

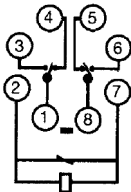

MK3PV-5-I, -S

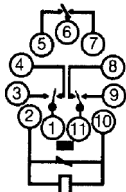

LED indicator and diode type (DC coil)
MK2PND-I, -S

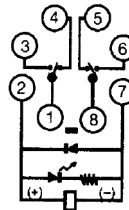

MK3PND-5-I, -S

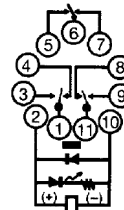

LED indicator and Varistor type (AC coil)
MK2PNV-I, -S

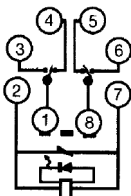

MK3PNV-5-I, -S

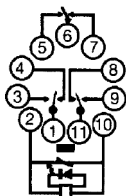

■ ACCESSORIES

**Track mounted socket
PF083A-E (conforming to DIN EN 50022)**

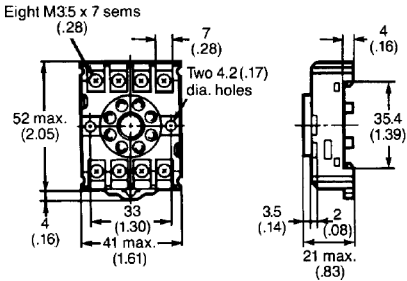

Terminal arrangement

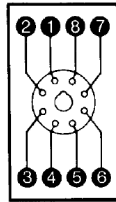

Mounting holes

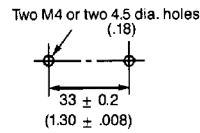

Mounting dimensions of relay with socket

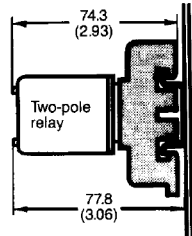

Note: Model PF083A-E can be used as a front connecting socket.

**Track mounted socket
PF113A-E (conforming to DIN EN 50022)**

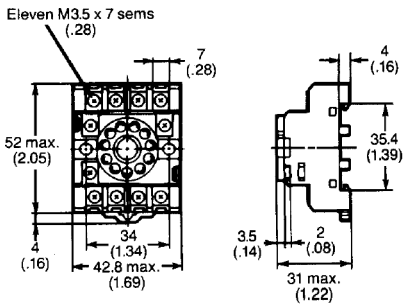

Terminal arrangement

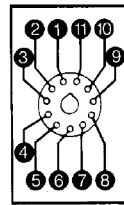

Mounting holes

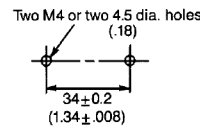

Mounting dimensions of relay with socket

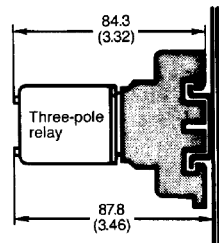

Note: Model PF113A-E can be used as a front connecting socket.

**Back connecting socket
MK2 sockets (8 pin)**

**PL08 (UL File No. E87929)
Solder terminals**

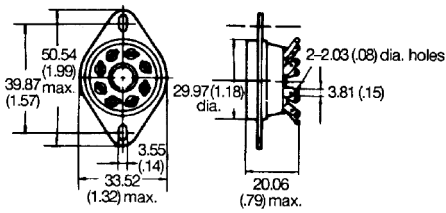

**PL08-Q
Wire wrap terminals**

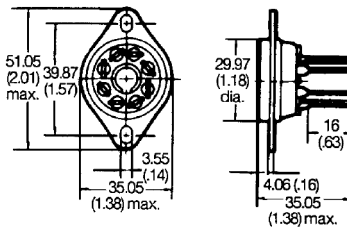

**Printed circuit board socket
PLE08-0**

PLE08-0

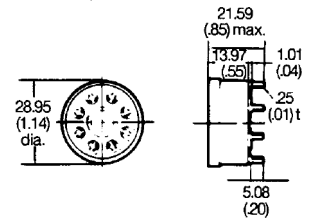

**Mounting holes
PL08**

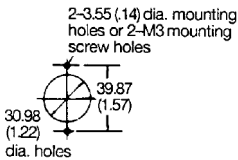

Mounting holes and panel cut-out applies to PL08 and PL08-Q

**PL08 type sockets and MK2 relay
Total height dimension**

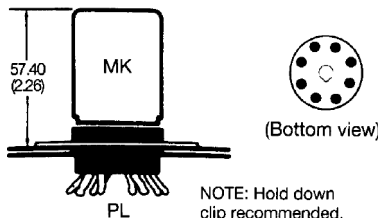

**Recommended PCB layout
PLE08-0**

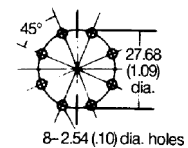

Unit: mm (inch)

■ ACCESSORIES (continued)

Back connecting socket
MK3 sockets (11 pin)

PL11 (UL File No. E87929)
Solder terminals

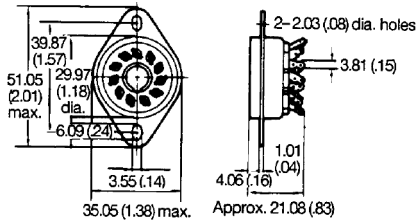

PL11-Q
Wire wrap terminals

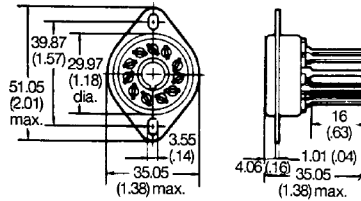

Printed circuit
board socket

PLE11-0

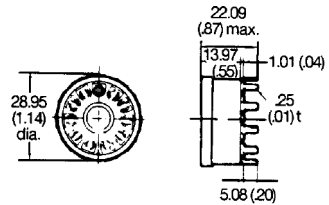

Mounting holes
PL11

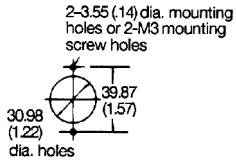

Mounting holes and panel cut-out applies to PL11 and PL11-Q

PL11 type sockets and MK3 relay
Total height dimension

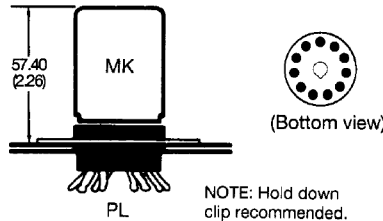

Recommended PCB layout
PLE11-0

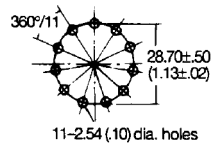

Mounting tracks

PFP-100N/PFP-50N
(conforming to DIN EN 500022)

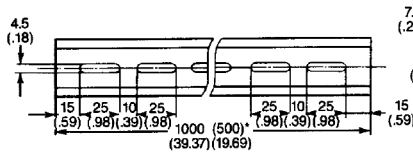

PFP-100N2
(conforming to DIN EN 500022)

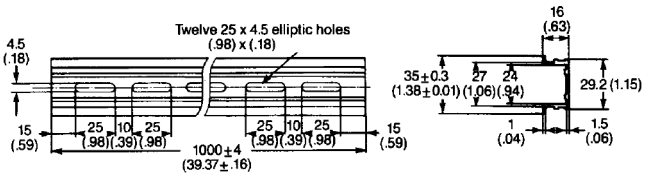

- Note: 1. *This dimension applies to mounting track PFP-50N.
2. A total of twelve 25 x 4.50 mm (0.98 x 0.18 in) elliptical holes is provided with six holes cut from each rail end at a pitch of 10 mm (0.39 in) holes.

PFP-M end plate

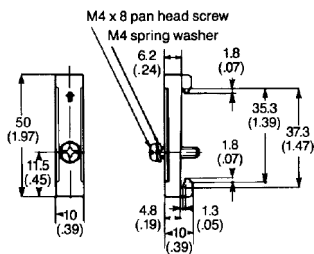

Note: Use of Type PFP-M end plate is recommended to secure the socket on the mounting track. Be sure that the engraved arrow mark on the surface of the end plate faces upward and then tighten the screw firmly with a screwdriver.

■ APPROVALS

UL (File No. E41515)/CSA (File Nos. LR41408 and LR335535)

| Type | Contact form | Coil ratings | Contact ratings |
|-------------|--------------|------------------------------|--------------------------|
| MK2P-I, -S | DPDT | 6 to 250 VAC 6 to 110 VDC | 10 A, 250 VAC, Resistive |
| | | | 10 A, 28 VDC, Resistive |
| | | | 7 A, 250 VAC, Inductive |
| MK3P5-I, -S | 3PDT | 6 to 250 VAC 6 to 110 VDC | 10 A, 120 VAC, Resistive |
| | | | 10 A, 28 VDC, Resistive |
| | | | 10 A, 250 VAC, Resistive |
| | | | 7 A, 250 VAC, Inductive |

SEV, DEMKO

| Type | Contact form | Coil ratings | Contact ratings |
|-------------|--------------|--------------|-----------------------------------------|
| MK2P-I, -S | DPDT | 6 to 110 VDC | 10 A, 250 VAC (NO) ($\cos\theta = 1$) |
| | | | 5 A, 250 VAC (NC) ($\cos\theta = 1$) |
| | | | 10 A, 280 VDC (NO) |
| MK3P5-I, -S | 3PDT | 6 to 240 VAC | 5 A, 280 VDC (NC) |
| | | | 7 A, 250 VAC ($\cos\theta = 0.4$) |

TUV (File No. R9051410)

| Type | Contact form | Coil ratings | Contact ratings |
|-------------|--------------|---------------------------------------------------------------|-----------------------------------------|
| MK2P-I, -S | DPDT | 6, 12, 24, 48, 100, 110 VDC | 10 A, 250 VAC (NO) ($\cos\theta = 1$) |
| | | | 5 A, 250 VAC (NC) ($\cos\theta = 1$) |
| | | | 10 A, 280 VDC (NO) |
| MK3P5-I, -S | 3PDT | 6, 12, 24, 50, 110, 115, 120, 200, 220, 230, 240 VAC | 5 A, 280 VDC (NC) |
| | | | 7 A, 250 VAC ($\cos\theta = 0.4$) |
| | | | |

- Note: 1. The rated values approved by each of the safety standards (e.g., UL and CSA) may be different from the performance characteristics individually defined in this catalog.
 2. VDE, Nemko and Semko versions are available. Please consult your OMRON representative for further information.
 3. In the interest of product improvement, specifications are subject to change.

OMRON ELECTRONICS, INC.

One East Commerce Drive
Schaumburg, IL 60173
1-800-55-OMRON

Cat. No. GC RLY7

01/00

Specifications subject to change without notice.

OMRON CANADA, INC.

885 Milner Avenue
Scarborough, Ontario M1B 5V8
416-286-6465

Printed in the U.S.A.