

**Under Development**  
**Preliminary**

MITSUBISHI LASER DIODES  
**ML1XX14 SERIES**  
FOR OPTICAL INFORMATION SYSTEMS

**TYPE  
NAME**

**ML101J14, ML120G14**

**This Model is under development. Therefore, please note that this data sheet may be changed without any notice.**

**DESCRIPTION**

ML1XX14 is a high power AlGaInP semiconductor laser which provides a stable, single transverse mode oscillation with emission wavelength of 660 nm and standard PULSE light output of 70mW.

ML1XX14 has a window-mirror-facet which improves the maximum output power. That leads to highly reliable and high-power operation.

**FEATURES**

- High Output Power: 50mW (CW) , 70mW (Pulse)
- Visible Light: 660nm (typ.)

**APPLICATION**

High-Density Optical Disc Drives  
Rewritable DVD(Digital Versatile Disc) Drives

**ABSOLUTE MAXIMUM RATINGS** Note 1)

Symbol	Parameter	Conditions	Ratings	Unit
Po	Light output power	CW	<b>60</b>	mW
		Pulse(Note 2)	<b>70</b>	
VRL	Reverse voltage	-	<b>2</b>	V
Tc	Case temperature	-	<b>-10 ~ +60</b>	°C
Tstg	Storage temperature	-	<b>-40 ~ +100</b>	°C

Note1: The maximum rating means the limitation over which the laser should not be operated even instant time, and this does not mean the guarantee of its lifetime. As for the reliability, please refer to the reliability report from Mitsubishi Semiconductor Quality Assurance Section.

Note2: TARGET SPEC /Condition Duty less than 50%, pulse width less than 0.1μs

**ELECTRICAL/OPTICAL CHARACTERISTICS (Tc=25°C)**

Symbol	Parameter	Test conditions	Min.	Typ.	Max	Unit
Ith	Threshold current	CW	-	<b>57</b>	-	mA
Iop	Operating current	CW, Po=50mW	-	<b>132</b>	-	mA
Vop	Operating voltage	CW, Po=50mW	-	<b>2.5</b>	<b>3.0</b>	V
η	Slope efficiency	CW, Po=50mW	-	<b>0.67</b>	-	mW/mA
λp	Peak wavelength	CW, Po=50mW	<b>655</b>	<b>660</b>	<b>666</b>	nm
θ//	Beam divergence angle (parallel)	CW, Po=50mW	-	<b>8.5</b>	-	°
θ⊥	Beam divergence angle (perpendicular)	CW, Po=50mW	-	<b>22</b>	-	°

MITSUBISHI LASER DIODES  
**ML1XX14 SERIES**

FOR OPTICAL INFORMATION SYSTEMS

**OUTLINE DRAWINGS**

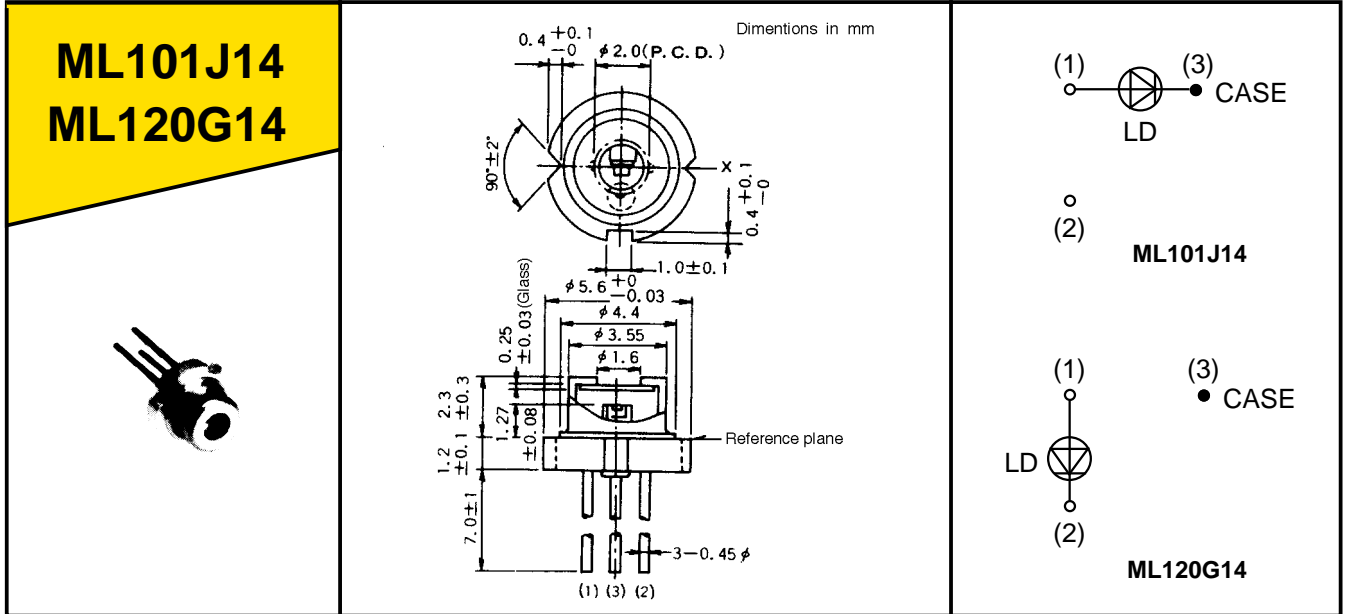

There is no model with a monitor photo diode in ML1XX14 series.

## Typical Characteristics

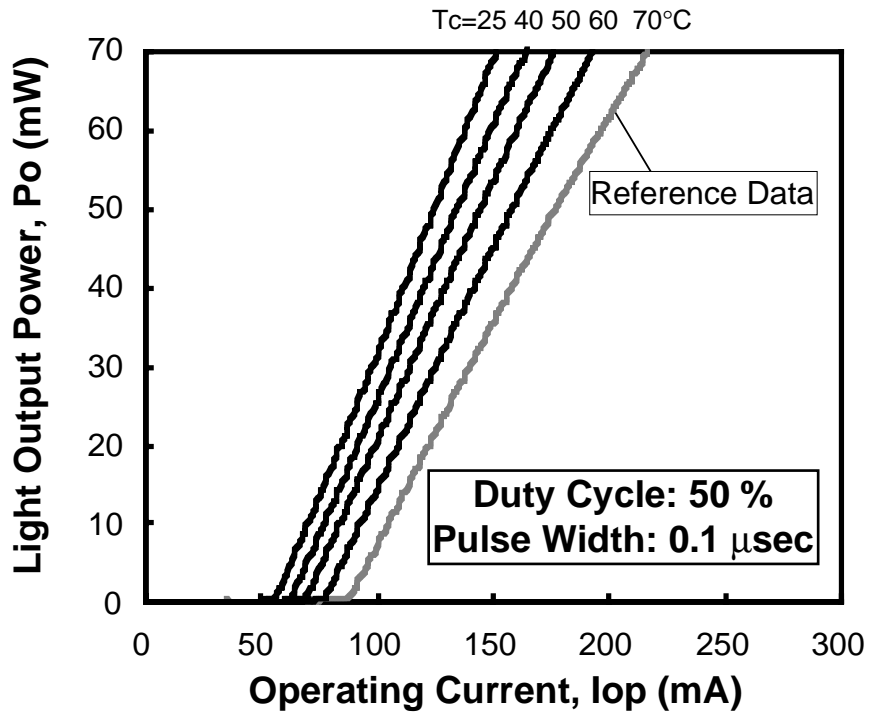

### Light Output Power vs. Current (Pulse)

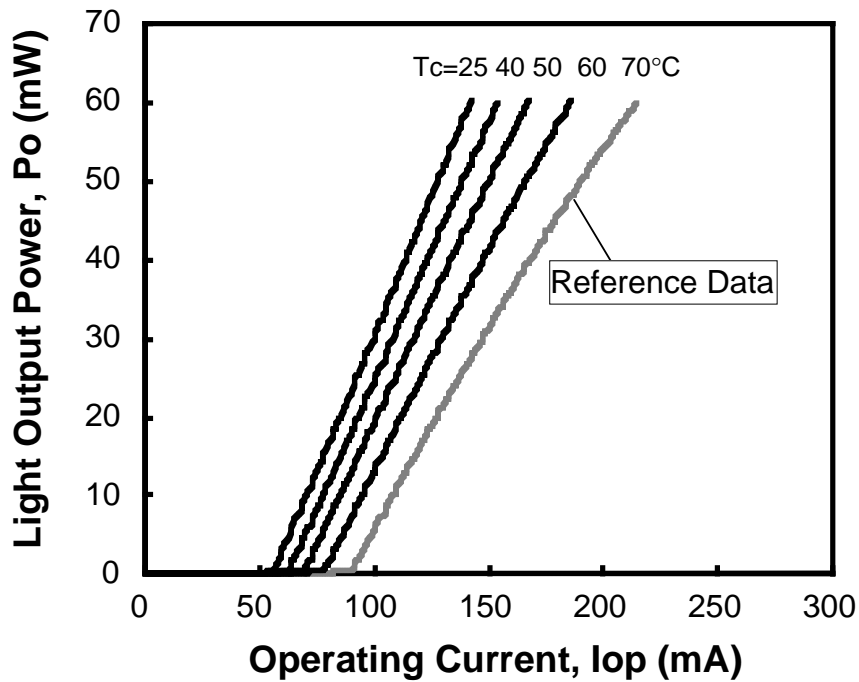

### Light Output Power vs. Current (CW)

MITSUBISHI LASER DIODES  
**ML1XX14 SERIES**

FOR OPTICAL INFORMATION SYSTEMS

### Typical Characteristics

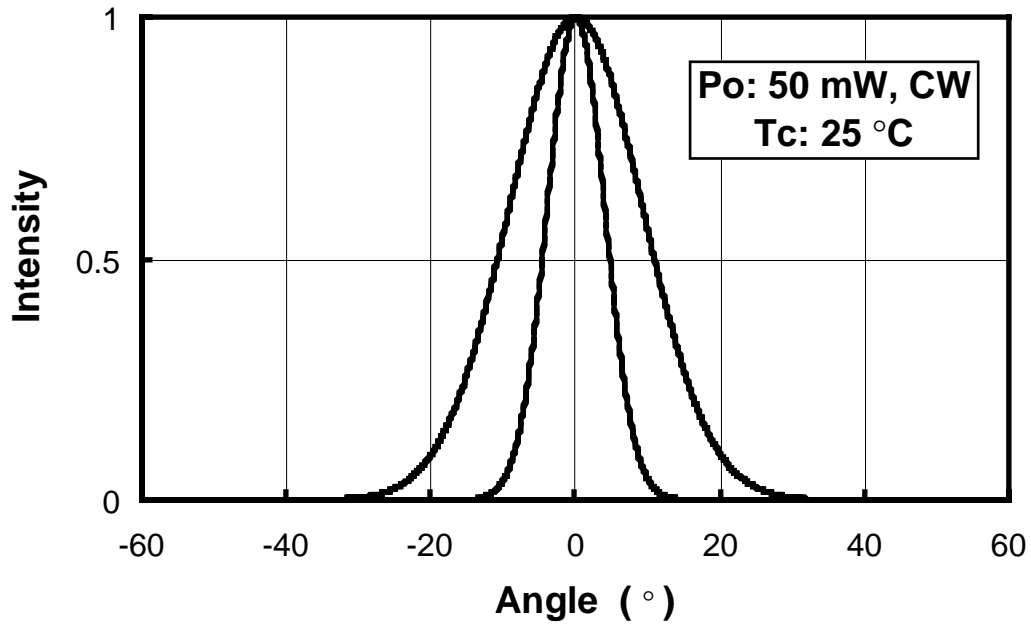

### Far Field Patterns

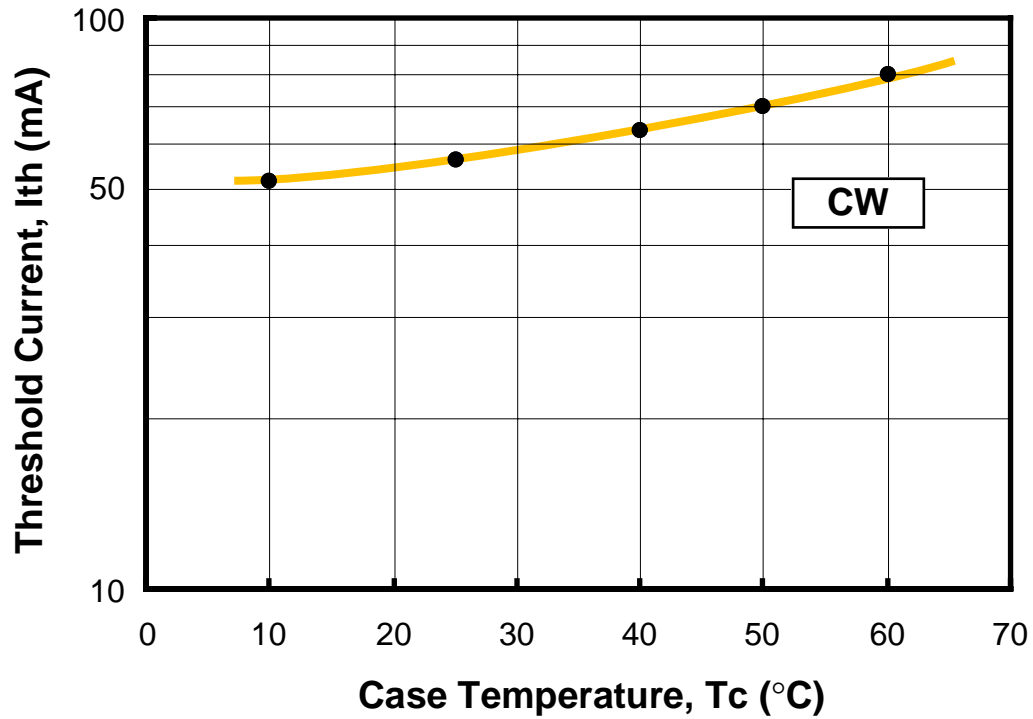

### Threshold Current vs Temperature

## Typical Characteristics

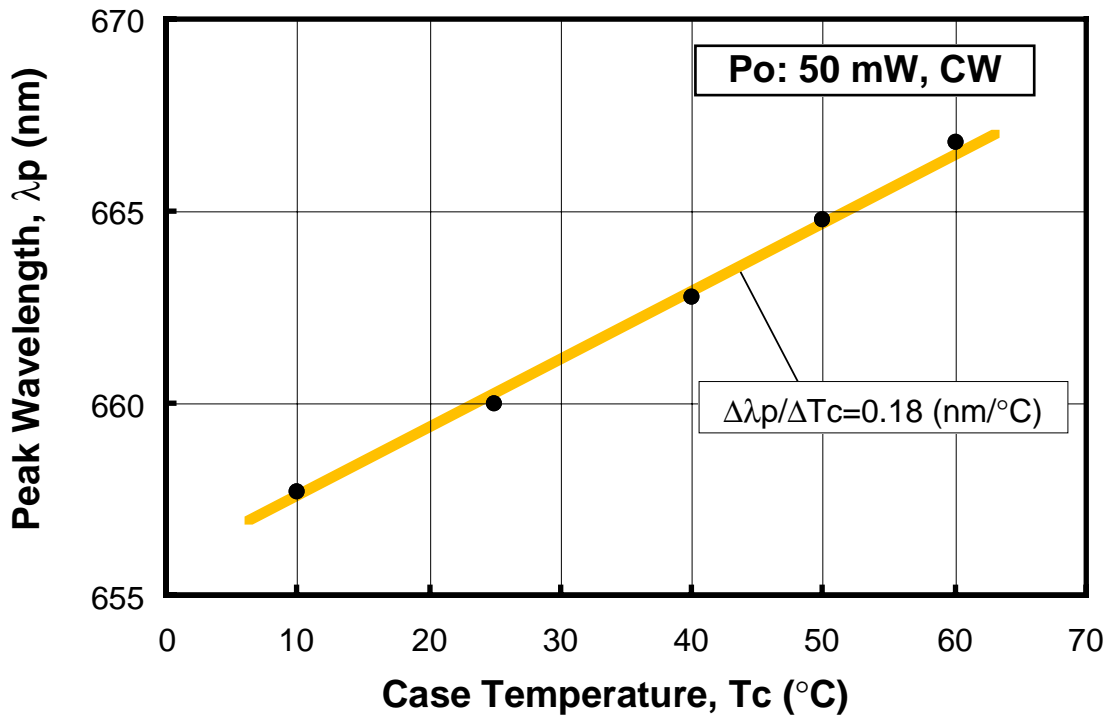

## Temperature dependence of Peak Wavelength

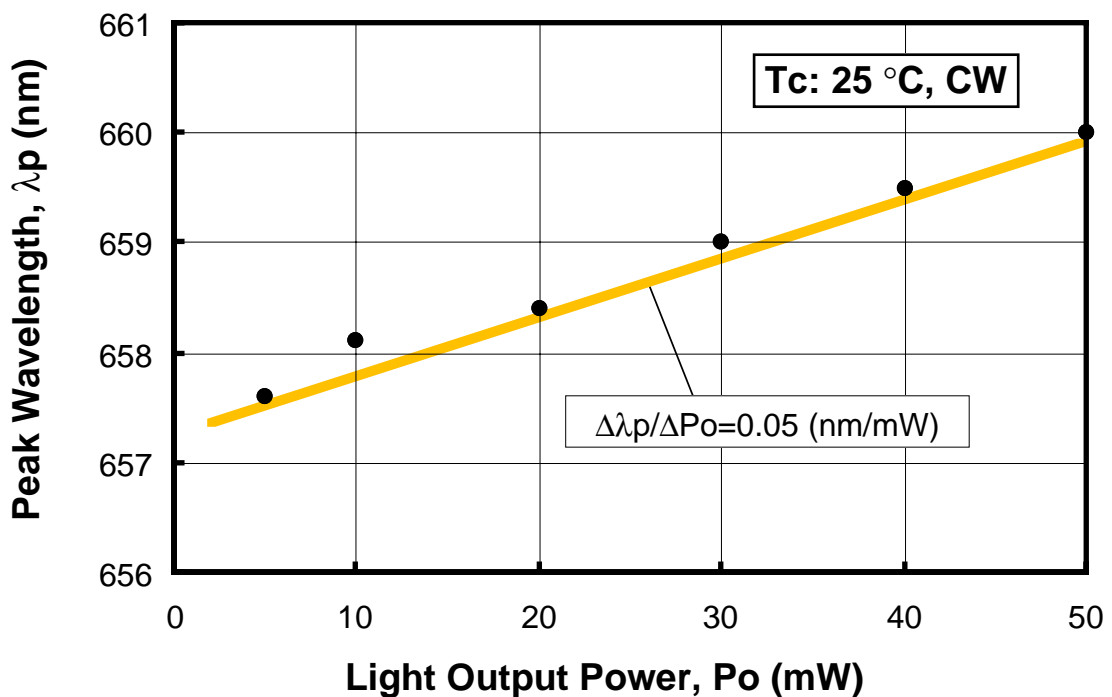

## Light Output Power dependence of Peak Wavelength