

MMBZ5226B - MMBZ5257B Series Zeners

Tolerance: B = 5%

Absolute Maximum Ratings*

TA = 25°C unless otherwise noted

Parameter	Value	Units
Storage Temperature Range	-55 to +150	°C
Maximum Junction Operating Temperature	+ 150	°C
Total Device Dissipation	350	mW
Derate above 25°C	2.8	mW/°C

*These ratings are limiting values above which the serviceability of the diode may be impaired.

NOTES:

- 1) These ratings are based on a maximum junction temperature of 150 degrees C.
- 2) These are steady state limits. The factory should be consulted on applications involving pulsed or low duty cycle operations.

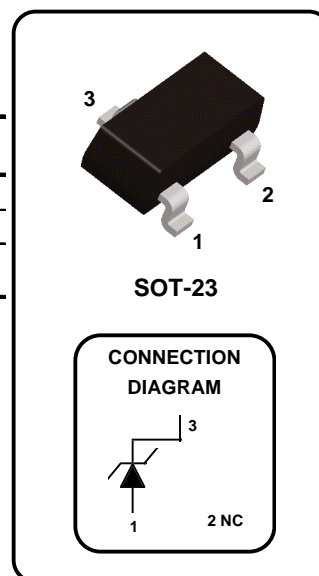

Electrical Characteristics

TA = 25°C unless otherwise noted

Device	Mark	V _Z (V)	Z _Z (Ω)	@	I _{ZT} (mA)	Z _{ZK} (Ω)	@	I _{ZK} (mA)	V _R (V)	@	I _R (μA)
MMBZ 5226B	8A	3.3	28	20	1,600	0.25	1.0	25			
MMBZ 5227B	8B	3.6	24	20	1,700	0.25	1.0	15			
MMBZ 5228B	8C	3.9	23	20	1,900	0.25	1.0	10			
MMBZ 5229B	8D	4.3	22	20	1,000	0.25	1.0	5.0			
MMBZ 5230B	8E	4.7	19	20	1,900	0.25	2.0	5.0			
MMBZ 5231B	8F	5.1	17	20	1,600	0.25	2.0	5.0			
MMBZ 5232B	8G	5.6	11	20	1,600	0.25	3.0	5.0			
MMBZ 5233B	8H	6.0	7.0	20	1,600	0.25	3.5	5.0			
MMBZ 5234B	8J	6.2	7.0	20	1,000	0.25	4.0	5.0			
MMBZ 5235B	8K	6.8	5.0	20	750	0.25	5.0	3.0			
MMBZ 5236B	8L	7.5	6.0	20	500	0.25	6.0	3.0			
MMBZ 5237B	8M	8.2	8.0	20	500	0.25	6.5	3.0			
MMBZ 5238B	8N	8.7	8.0	20	600	0.25	6.5	3.0			
MMBZ 5239B	8P	9.1	10	20	600	0.25	7.0	3.0			
MMBZ 5240B	8Q	10	17	20	600	0.25	8.0	3.0			
MMBZ 5241B	8R	11	22	20	600	0.25	8.4	2.0			
MMBZ 5242B	8S	12	30	20	600	0.25	9.1	1.0			

V_F Forward Voltage = 0.9 V Maximum @ I_F = 10 mA for all MMBZ 5200 series

NOTE: National preferred devices in **BOLD**

MMBZ Series Zeners
(continued)

MMBZ5226B - MMBZ5257B Series

Electrical Characteristics (continued) TA = 25°C unless otherwise noted

Device	Mark	V _Z (V)	Z _Z (Ω)	I _{ZT} (mA)	Z _{ZK} (Ω)	I _{ZK} (mA)	V _R (V)	I _R (nA)
MMBZ 5243B	8T	13	13	9.5	600	0.25	9.9	500
MMBZ 5244B	8U	14	15	9.0	600	0.25	10	100
MMBZ 5245B	8V	15	16	8.5	600	0.25	11	100
MMBZ 5246B	8W	16	17	7.8	600	0.25	12	100
MMBZ 5247B	8X	17	19	7.4	600	0.25	13	100
MMBZ 5248B	8Y	18	21	7.0	600	0.25	14	100
MMBZ 5249B	8Z	19	23	6.6	600	0.25	14	100
MMBZ 5250B	81A	20	25	6.2	600	0.25	15	100
MMBZ 5251B	81B	22	29	5.6	600	0.25	17	100
MMBZ 5252B	81C	24	33	5.2	600	0.25	18	100
MMBZ 5253B	81D	25	35	5.0	600	0.25	19	100
MMBZ 5254B	81E	27	41	4.6	600	0.25	21	100
MMBZ 5255B	81F	28	44	4.5	600	0.25	21	100
MMBZ 5256B	81G	30	49	4.2	600	0.25	23	100
MMBZ 5257B	81H	33	58	3.8	700	0.25	25	100

V_F Forward Voltage = 0.9 V Maximum @ I_F = 10 mA for all MMBZ 5200 series

NOTE: National preferred devices in **BOLD**

SOT-23 Tape and Reel Data and Package Dimensions



SOT-23 Packaging Configuration: Figure 10

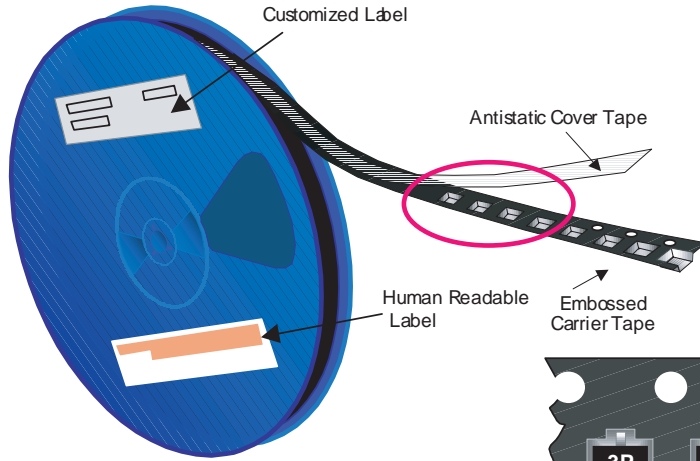

Packaging Description:

SOT-23 parts are shipped in tape. The carrier tape is made from a dissipative (carbon filled) polycarbonate resin. The cover tape is a multilayer film (Heat Activated Adhesive in nature) primarily composed of polyester film, adhesive layer, sealant, and anti-static sprayed agent. These reeled parts in standard option are shipped with 3,000 units per 7" or 177mm diameter reel. The reels are dark blue in color and is made of polystyrene plastic (anti-static coated). Other option comes in 10,000 units per 13" or 330mm diameter reel. This and some other options are described in the Packaging Information table.

These full reels are individually labeled and placed inside a standard intermediate made of recyclable corrugated brown paper with a Fairchild logo printing. One pizza box contains eight reels maximum. And these intermediate boxes are placed inside a labeled shipping box which comes in different sizes depending on the number of parts shipped.

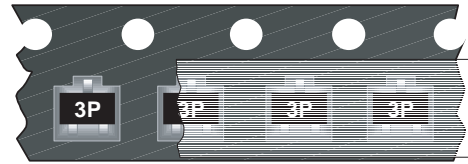

SOT-23 Unit Orientation

SOT-23 Packaging Information		
Packaging Option	Standard (no flow code)	D87Z
Packaging type	TNR	TNR
Qty per Reel/Tube/Bag	3,000	10,000
Reel Size	7" Dia	13"
Box Dimension (mm)	187x107x183	343x343x64
Max qty per Box	24,000	30,000
Weight per unit (gm)	0.0082	0.0082
Weight per Reel (kg)	0.1175	0.4006
Note/Comments		

343mm x 342mm x 64mm
Intermediate box for L87Z Option

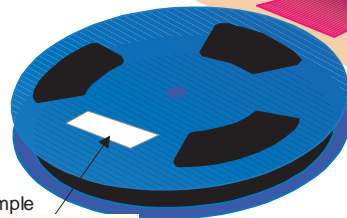

Human Readable Label sample

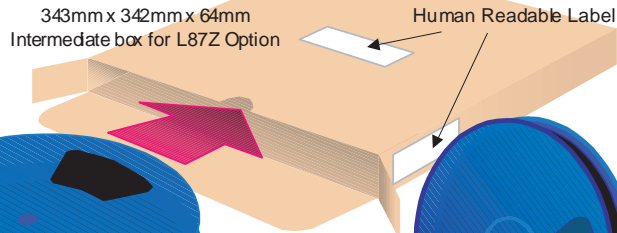

Human readable Label

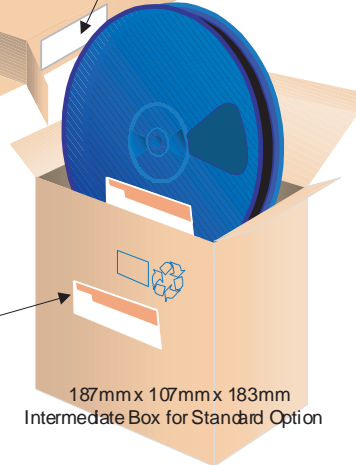

187mm x 107mm x 183mm
Intermediate Box for Standard Option

SOT-23 Tape Leader and Trailer Configuration: Figure 20

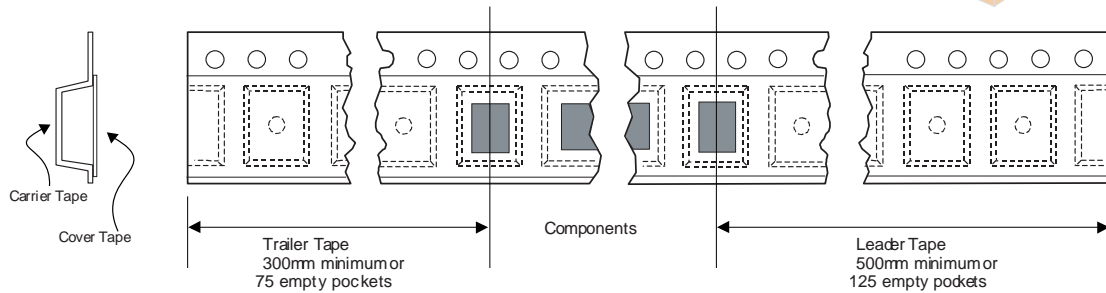

SOT-23 Tape and Reel Data and Package Dimensions, continued

SOT-23 Embossed Carrier Tape Configuration: Figure 3.0

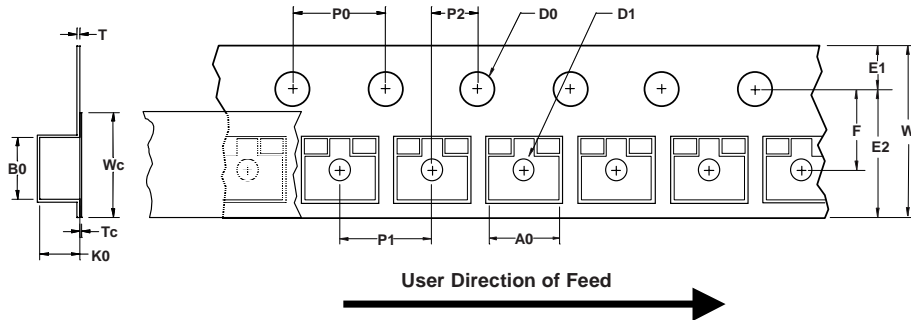

Dimensions are in millimeter														
Pkg type	A0	B0	W	D0	D1	E1	E2	F	P1	P0	K0	T	Wc	Tc
SOT-23 (8mm)	3.15 ±0.10	2.77 ±0.10	8.0 ±0.3	1.55 ±0.05	1.125 ±0.125	1.75 ±0.10	6.25 min	3.50 ±0.05	4.0 ±0.1	4.0 ±0.1	1.30 ±0.10	0.228 ±0.013	5.2 ±0.3	0.06 ±0.02

Notes: A0, B0, and K0 dimensions are determined with respect to the EIA/Jedec RS-481 rotational and lateral movement requirements (see sketches A, B, and C).

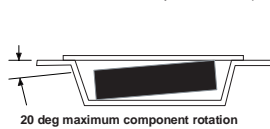

Sketch A (Side or Front Sectional View)
Component Rotation

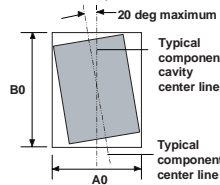

Sketch B (Top View)
Component Rotation

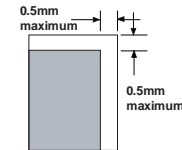

Sketch C (Top View)
Component lateral movement

SOT-23 Reel Configuration: Figure 4.0

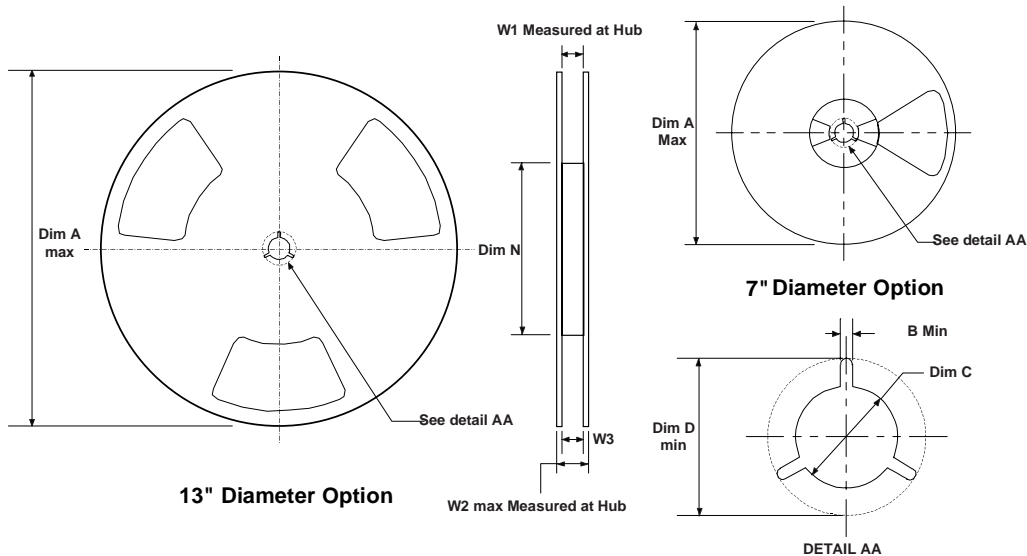

Dimensions are in inches and millimeters									
Tape Size	Reel Option	Dim A	Dim B	Dim C	Dim D	Dim N	Dim W1	Dim W2	Dim W3 (LSL-USL)
8mm	7" Dia	7.00 177.8	0.059 1.5	512 +0.020/-0.008 13 +0.5/-0.2	0.795 20.2	2.165 55	0.331 +0.059/-0.000 8.4 +1.5/0	0.567 14.4	0.311 -0.429 7.9 - 10.9
8mm	13" Dia	13.00 330	0.059 1.5	512 +0.020/-0.008 13 +0.5/-0.2	0.795 20.2	4.00 100	0.331 +0.059/-0.000 8.4 +1.5/0	0.567 14.4	0.311 -0.429 7.9 - 10.9

SOT-23 Tape and Reel Data and Package Dimensions, continued

SOT-23 (FS PKG Code 49)

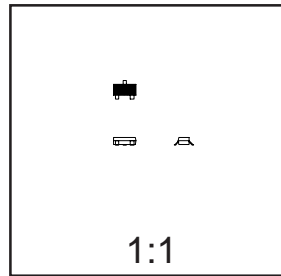
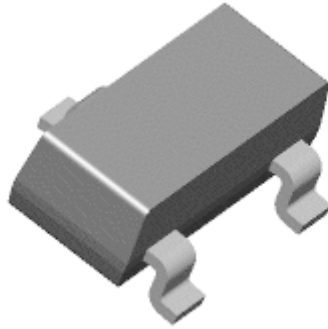

Scale 1:1 on letter size paper

Dimensions shown below are in:
inches [millimeters]

Part Weight per unit (gram): 0.0082

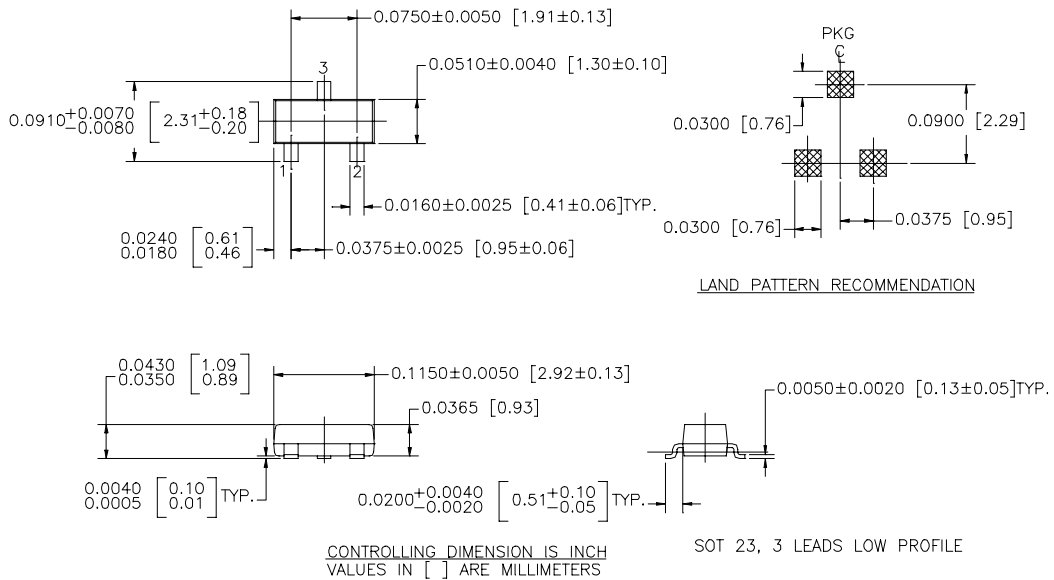

NOTE : UNLESS OTHERWISE SPECIFIED

1. STANDARD LEAD FINISH 150 MICROINCHES / 3.81 MICROMETERS
MINIMUM TIN / LEAD (SOLDER) ON ALLOY 42
2. REFERENCE JEDEC REGISTRATION TO-236, VARIATION AB, ISSUE G, DATED JUL 1993

TRADEMARKS

The following are registered and unregistered trademarks Fairchild Semiconductor owns or is authorized to use and is not intended to be an exhaustive list of all such trademarks.

ACEx™	HiSeC™	SuperSOT™-8
Bottomless™	ISOPLANAR™	SyncFET™
CoolFET™	MICROWIRE™	TinyLogic™
CROSSVOLT™	POP™	UHC™
E ² CMOS™	PowerTrench®	VCX™
FACT™	QFET™	
FACT Quiet Series™	QS™	
FAST®	Quiet Series™	
FASTr™	SuperSOT™-3	
GTO™	SuperSOT™-6	

DISCLAIMER

FAIRCHILD SEMICONDUCTOR RESERVES THE RIGHT TO MAKE CHANGES WITHOUT FURTHER NOTICE TO ANY PRODUCTS HEREIN TO IMPROVE RELIABILITY, FUNCTION OR DESIGN. FAIRCHILD DOES NOT ASSUME ANY LIABILITY ARISING OUT OF THE APPLICATION OR USE OF ANY PRODUCT OR CIRCUIT DESCRIBED HEREIN; NEITHER DOES IT CONVEY ANY LICENSE UNDER ITS PATENT RIGHTS, NOR THE RIGHTS OF OTHERS.

LIFE SUPPORT POLICY

FAIRCHILD'S PRODUCTS ARE NOT AUTHORIZED FOR USE AS CRITICAL COMPONENTS IN LIFE SUPPORT DEVICES OR SYSTEMS WITHOUT THE EXPRESS WRITTEN APPROVAL OF FAIRCHILD SEMICONDUCTOR CORPORATION. As used herein:

1. Life support devices or systems are devices or systems which, (a) are intended for surgical implant into the body, or (b) support or sustain life, or (c) whose failure to perform when properly used in accordance with instructions for use provided in the labeling, can be reasonably expected to result in significant injury to the user.
2. A critical component is any component of a life support device or system whose failure to perform can be reasonably expected to cause the failure of the life support device or system, or to affect its safety or effectiveness.

PRODUCT STATUS DEFINITIONS

Definition of Terms

Datasheet Identification	Product Status	Definition
Advance Information	Formative or In Design	This datasheet contains the design specifications for product development. Specifications may change in any manner without notice.
Preliminary	First Production	This datasheet contains preliminary data, and supplementary data will be published at a later date. Fairchild Semiconductor reserves the right to make changes at any time without notice in order to improve design.
No Identification Needed	Full Production	This datasheet contains final specifications. Fairchild Semiconductor reserves the right to make changes at any time without notice in order to improve design.
Obsolete	Not In Production	This datasheet contains specifications on a product that has been discontinued by Fairchild semiconductor. The datasheet is printed for reference information only.