

MMUN2211LT1 Series

Preferred Devices

Bias Resistor Transistor

NPN Silicon Surface Mount Transistor with Monolithic Bias Resistor Network

This new series of digital transistors is designed to replace a single device and its external resistor bias network. The BRT (Bias Resistor Transistor) contains a single transistor with a monolithic bias network consisting of two resistors; a series base resistor and a base-emitter resistor. The BRT eliminates these individual components by integrating them into a single device. The use of a BRT can reduce both system cost and board space. The device is housed in the SOT-23 package which is designed for low power surface mount applications.

- Simplifies Circuit Design
- Reduces Board Space and Component Count
- The SOT-23 package can be soldered using wave or reflow. The modified gull-winged leads absorb thermal stress during soldering eliminating the possibility of damage to the die.
- Available in 8 mm embossed tape and reel. Use the Device Number to order the 7 inch/3000 unit reel. Replace "T1" with "T3" in the Device Number to order the 13 inch/10,000 unit reel.

MAXIMUM RATINGS ($T_A = 25^\circ\text{C}$ unless otherwise noted)

Rating	Symbol	Value	Unit
Collector-Base Voltage	V_{CBO}	50	Vdc
Collector-Emitter Voltage	V_{CEO}	50	Vdc
Collector Current	I_C	100	mAdc
Total Power Dissipation @ $T_A = 25^\circ\text{C}$ (Note 1) Derate above 25°C	P_D	200 1.6	mW mW/ $^\circ\text{C}$

DEVICE MARKING AND RESISTOR VALUES

Device	Marking	R1(K)	R2(K)
MMUN2211LT1	A8A	10	10
MMUN2212LT1	A8B	22	22
MMUN2213LT1	A8C	47	47
MMUN2214LT1	A8D	10	47
MMUN2215LT1	A8E	10	∞
MMUN2216LT1	A8F	4.7	∞
MMUN2230LT1	A8G	1.0	1.0
MMUN2231LT1	A8H	2.2	2.2
MMUN2232LT1	A8J	4.7	4.7
MMUN2233LT1	A8K	4.7	47
MMUN2234LT1	A8L	22	47
MMUN2238LT1	A8R	2.2	∞
MMUN2241LT1	A8U	100	∞

1. Device mounted on a FR-4 glass epoxy printed circuit board using the minimum recommended footprint.



ON Semiconductor®

<http://onsemi.com>

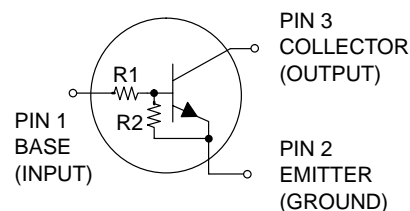

MARKING DIAGRAM

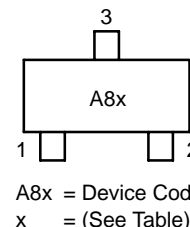
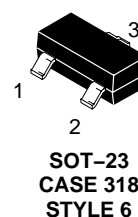

ORDERING INFORMATION

Device	Package	Shipping†
MMUN2211LT1	SOT-23	3000/Tape & Reel
MMUN2212LT1	SOT-23	3000/Tape & Reel
MMUN2213LT1	SOT-23	3000/Tape & Reel
MMUN2214LT1	SOT-23	3000/Tape & Reel
MMUN2215LT1	SOT-23	3000/Tape & Reel
MMUN2216LT1	SOT-23	3000/Tape & Reel
MMUN2230LT1	SOT-23	3000/Tape & Reel
MMUN2231LT1	SOT-23	3000/Tape & Reel
MMUN2232LT1	SOT-23	3000/Tape & Reel
MMUN2233LT1	SOT-23	3000/Tape & Reel
MMUN2234LT1	SOT-23	3000/Tape & Reel
MMUN2238LT1	SOT-23	3000/Tape & Reel
MMUN2241LT1	SOT-23	3000/Tape & Reel

†For information on tape and reel specifications, including part orientation and tape sizes, please refer to our Tape and Reel Packaging Specification Brochure, BRD8011/D.

Preferred devices are recommended choices for future use and best overall value.

MMUN2211LT1 Series

THERMAL CHARACTERISTICS

Rating	Symbol	Value	Unit
Thermal Resistance – Junction-to-Ambient (surface mounted)	$R_{\theta JA}$	625	°C/W
Operating and Storage Temperature Range	T_J, T_{stg}	-65 to +150	°C
Maximum Temperature for Soldering Purposes, Time in Solder Bath	T_L	260 10	°C Sec

ELECTRICAL CHARACTERISTICS ($T_A = 25^\circ\text{C}$ unless otherwise noted)

Characteristic	Symbol	Min	Typ	Max	Unit
----------------	--------	-----	-----	-----	------

OFF CHARACTERISTICS

Collector-Base Cutoff Current ($V_{CB} = 50\text{ V}, I_E = 0$)	I_{CBO}	-	-	100	nAdc
Collector-Emitter Cutoff Current ($V_{CE} = 50\text{ V}, I_B = 0$)	I_{CEO}	-	-	500	nAdc
Emitter-Base Cutoff Current ($V_{EB} = 6.0\text{ V}, I_C = 0$)	I_{EBO}	-	-	0.5	mAdc
	MMUN2211LT1	-	-	0.2	
	MMUN2212LT1	-	-	0.1	
	MMUN2213LT1	-	-	0.2	
	MMUN2214LT1	-	-	0.9	
	MMUN2215LT1	-	-	1.9	
	MMUN2216LT1	-	-	4.3	
	MMUN2230LT1	-	-	2.3	
	MMUN2231LT1	-	-	1.5	
	MMUN2232LT1	-	-	0.18	
	MMUN2233LT1	-	-	0.13	
	MMUN2234LT1	-	-	4.0	
	MMUN2238LT1	-	-	0.1	
	MMUN2241LT1	-	-		
Collector-Base Breakdown Voltage ($I_C = 10\ \mu\text{A}, I_E = 0$)	$V_{(BR)CBO}$	50	-	-	Vdc
Collector-Emitter Breakdown Voltage (Note 2), ($I_C = 2.0\text{ mA}, I_B = 0$)	$V_{(BR)CEO}$	50	-	-	Vdc

ON CHARACTERISTICS (Note 2)

DC Current Gain ($V_{CE} = 10\text{ V}, I_C = 5.0\text{ mA}$)	h_{FE}	35	60	-	
	MMUN2211LT1	60	100	-	
	MMUN2212LT1	80	140	-	
	MMUN2213LT1	80	140	-	
	MMUN2214LT1	160	350	-	
	MMUN2215LT1	160	350	-	
	MMUN2216LT1	3.0	5.0	-	
	MMUN2230LT1	8.0	15	-	
	MMUN2231LT1	15	30	-	
	MMUN2232LT1	80	200	-	
	MMUN2233LT1	80	150	-	
	MMUN2234LT1	160	350	-	
	MMUN2238LT1	160	350	-	
	MMUN2241LT1				
Collector-Emitter Saturation Voltage ($I_C = 10\text{ mA}, I_B = 0.3\text{ mA}$) ($I_C = 10\text{ mA}, I_B = 5\text{ mA}$) MMUN2230LT1/MMUN2231LT1 ($I_C = 10\text{ mA}, I_B = 1\text{ mA}$) MMUN2215LT1/MMUN2216LT1 MMUN2232LT1/MMUN2233LT1/MMUN2234LT1/ MMUN2238LT1	$V_{CE(sat)}$	-	-	0.25	Vdc

2. Pulse Test: Pulse Width < 300 μs , Duty Cycle < 2.0%.

MMUN2211LT1 Series

ELECTRICAL CHARACTERISTICS (T_A = 25°C unless otherwise noted) (Continued)

Characteristic	Symbol	Min	Typ	Max	Unit	
ON CHARACTERISTICS (Note 3)						
Output Voltage (on) (V _{CC} = 5.0 V, V _B = 2.5 V, R _L = 1.0 k Ω)	MMUN2211LT1 MMUN2212LT1 MMUN2214LT1 MMUN2215LT1 MMUN2216LT1 MMUN2230LT1 MMUN2231LT1 MMUN2232LT1 MMUN2233LT1 MMUN2234LT1 MMUN2238LT1 (V _{CC} = 5.0 V, V _B = 3.5 V, R _L = 1.0 k Ω) (V _{CC} = 5.0 V, V _B = 5.0 V, R _L = 1.0 k Ω)	V _{OL}	-	-	0.2	Vdc
Output Voltage (off) (V _{CC} = 5.0 V, V _B = 0.5 V, R _L = 1.0 k Ω) (V _{CC} = 5.0 V, V _B = 0.050 V, R _L = 1.0 k Ω) (V _{CC} = 5.0 V, V _B = 0.25 V, R _L = 1.0 k Ω)	MMUN2230LT1 MMUN2215LT1 MMUN2216LT1 MMUN2233LT1 MMUN2238LT1	V _{OH}	4.9	-	-	Vdc
Input Resistor	MMUN2211LT1 MMUN2212LT1 MMUN2213LT1 MMUN2214LT1 MMUN2215LT1 MMUN2216LT1 MMUN2230LT1 MMUN2231LT1 MMUN2232LT1 MMUN2233LT1 MMUN2234LT1 MMUN2238LT1 MMUN2241LT1	R1	7.0 15.4 32.9 7.0 7.0 3.3 0.7 1.5 3.3 3.3 15.4 1.54 70	10 22 47 10 10 4.7 1.0 2.2 4.7 4.7 22 2.2 100	13 28.6 61.1 13 13 6.1 1.3 2.9 6.1 6.1 28.6 2.88 130	kΩ
Resistor Ratio	MMUN2211LT1/MMUN2212LT1/MMUN2213LT1 MMUN2214LT1 MMUN2215LT1/MMUN2216LT1/MMUN2238LT1 MMUN2241LT1 MMUN2230LT1/MMUN2231LT1/MMUN2232LT1 MMUN2233LT1 MMUN2234LT1	R1/R2	0.8 0.17 - - 0.8 0.055 0.38	1.0 0.21 - - 1.0 0.1 0.47	1.2 0.25 - - 1.2 0.185 0.56	

3. Pulse Test: Pulse Width < 300 μs, Duty Cycle < 2.0%.

MMUN2211LT1 Series

TYPICAL ELECTRICAL CHARACTERISTICS MMUN2211LT1

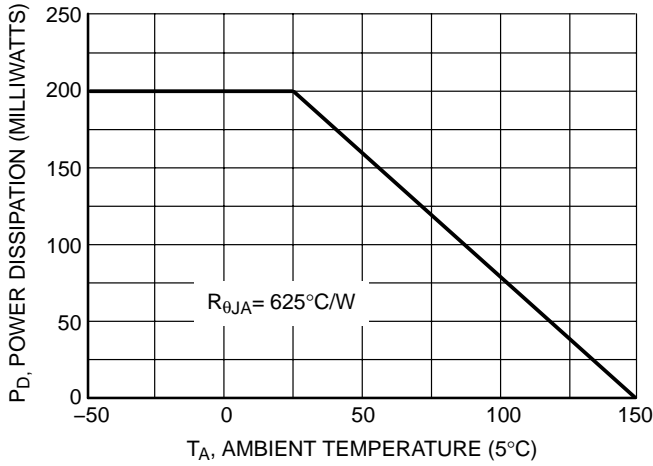

Figure 1. Derating Curve

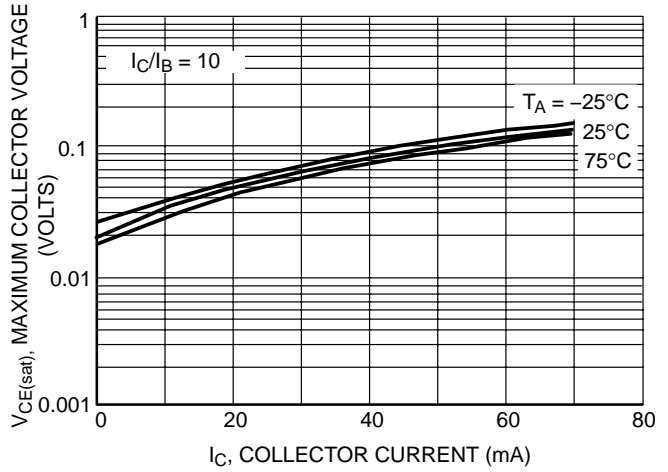

Figure 2. V_{CE(sat)} vs. I_C

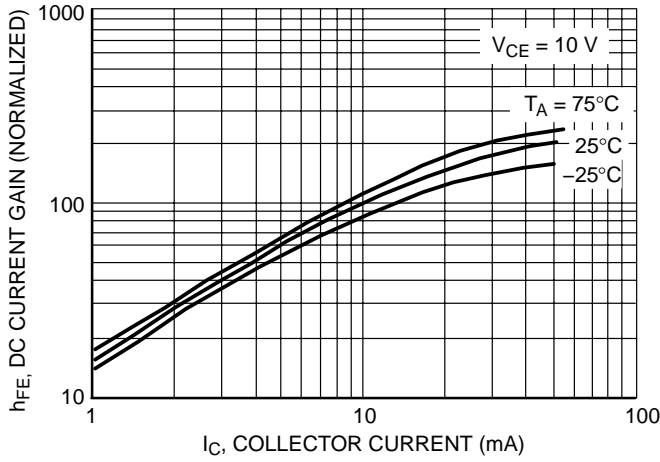

Figure 3. DC Current Gain

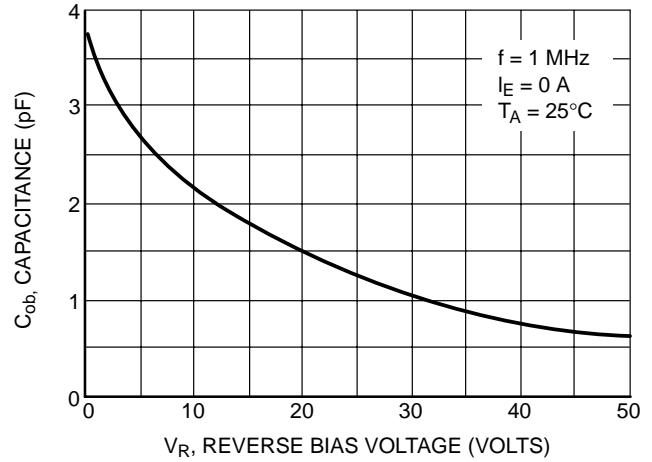

Figure 4. Output Capacitance

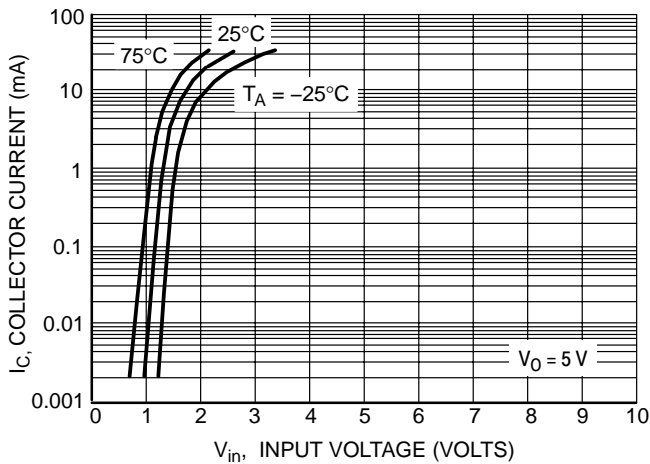

Figure 5. Output Current vs. Input Voltage

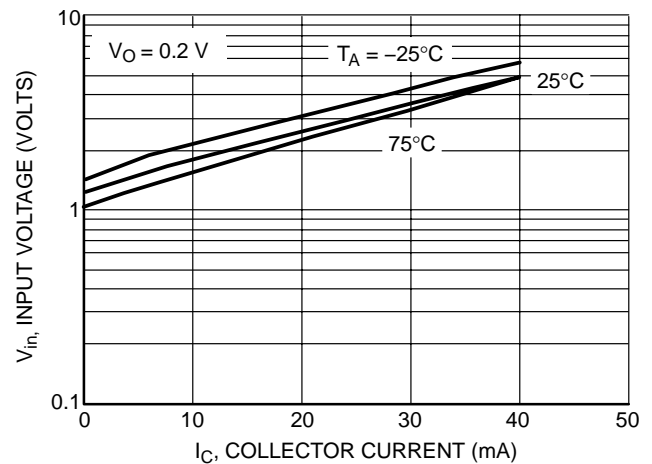

Figure 6. Input Voltage vs. Output Current

MMUN2211LT1 Series

TYPICAL ELECTRICAL CHARACTERISTICS MMUN2212LT1

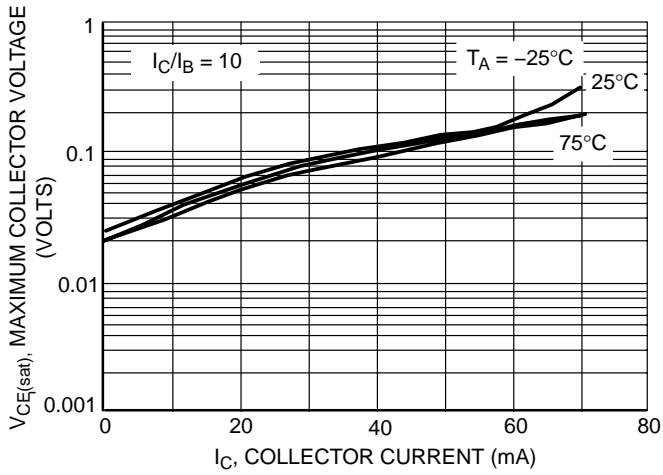

Figure 7. $V_{CE(sat)}$ vs. I_C

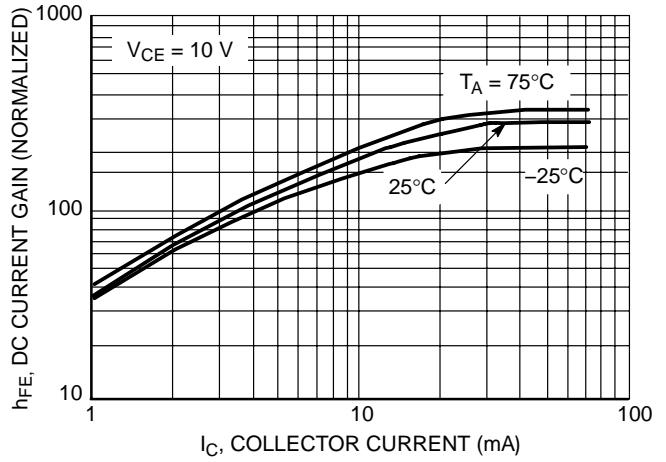

Figure 8. DC Current Gain

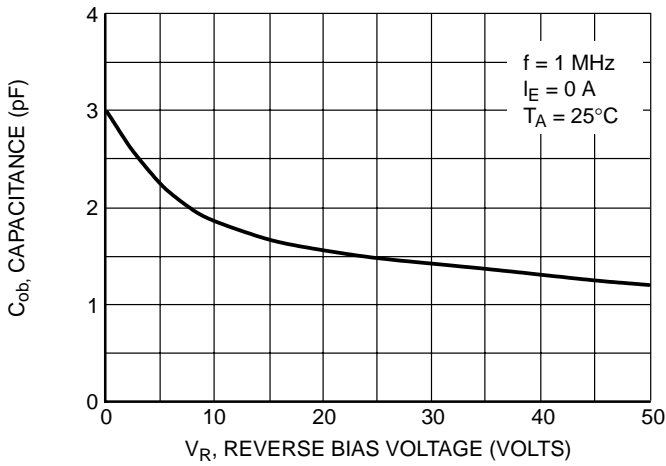

Figure 9. Output Capacitance

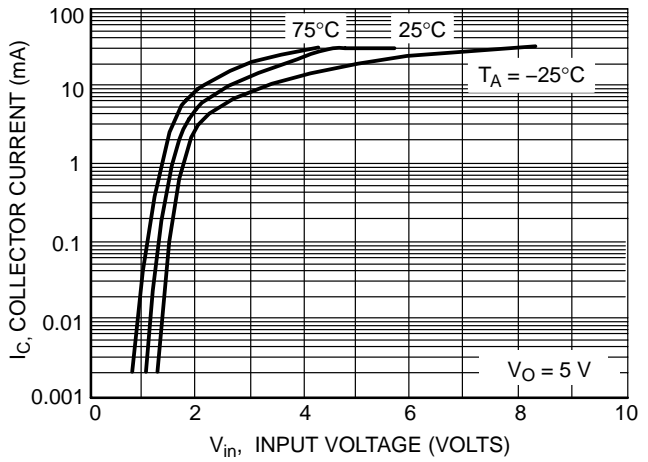

Figure 10. Output Current vs. Input Voltage

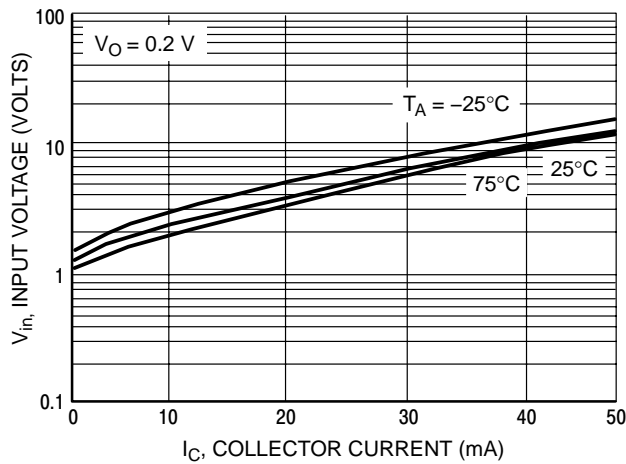

Figure 11. Input Voltage vs. Output Current

MMUN2211LT1 Series

TYPICAL ELECTRICAL CHARACTERISTICS MMUN2213LT1

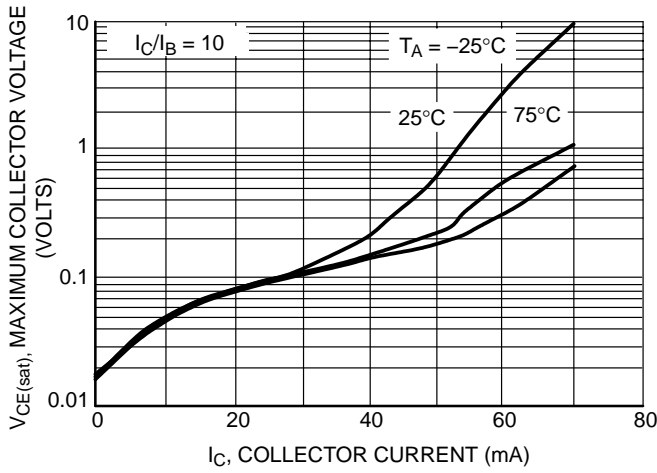

Figure 12. $V_{CE(sat)}$ vs. I_C

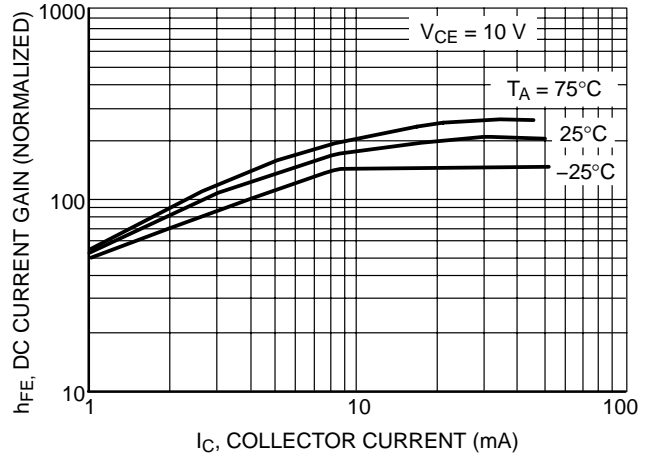

Figure 13. DC Current Gain

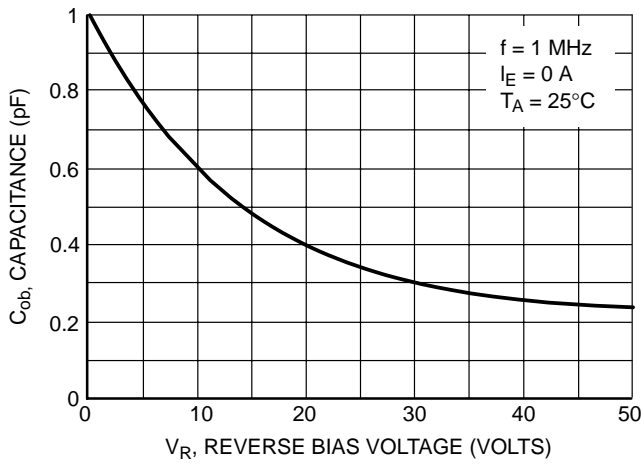

Figure 14. Output Capacitance

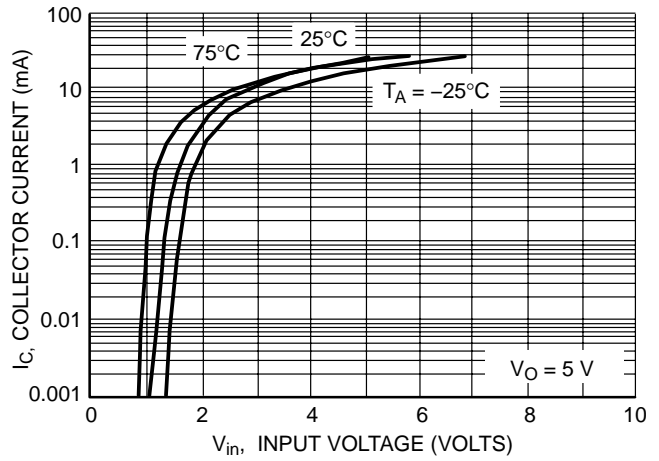

Figure 15. Output Current vs. Input Voltage

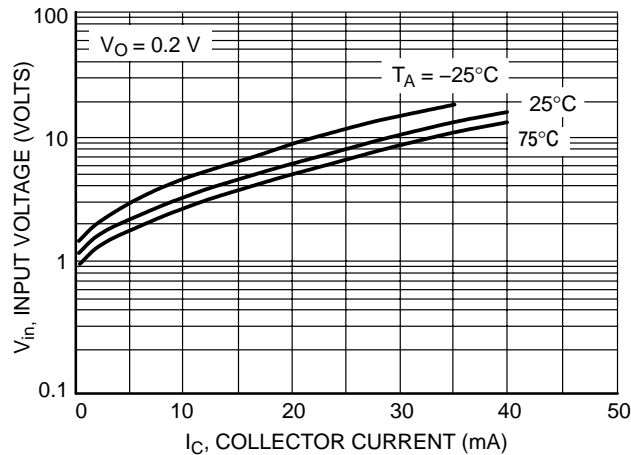

Figure 16. Input Voltage vs. Output Current

MMUN2211LT1 Series

TYPICAL ELECTRICAL CHARACTERISTICS MMUN2214LT1

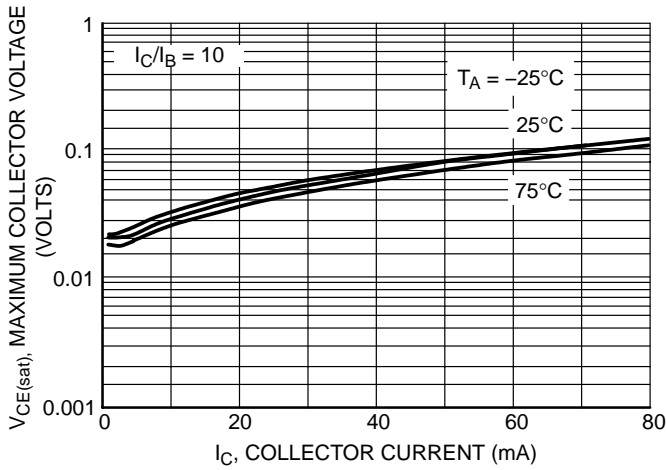

Figure 17. $V_{CE(sat)}$ vs. I_C

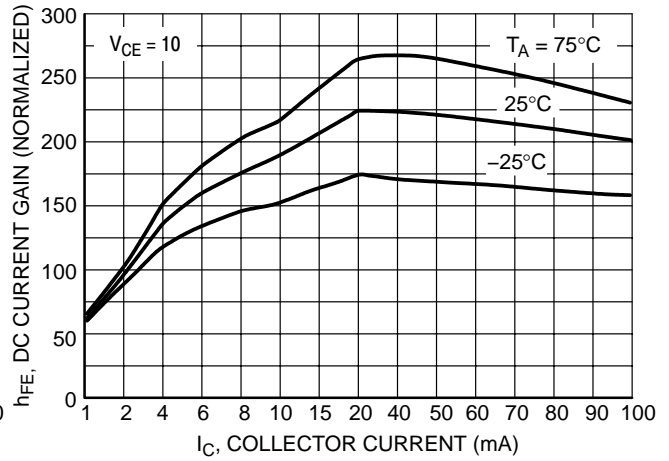

Figure 18. DC Current Gain

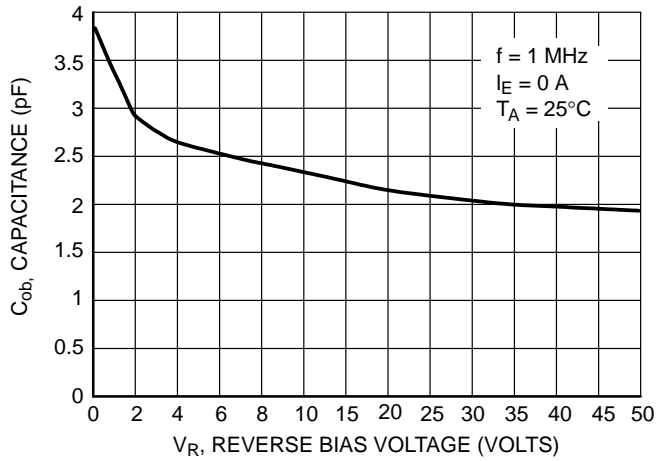

Figure 19. Output Capacitance

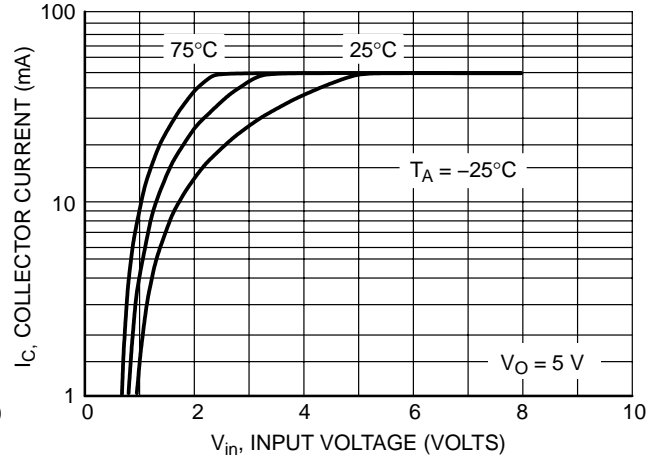

Figure 20. Output Current vs. Input Voltage

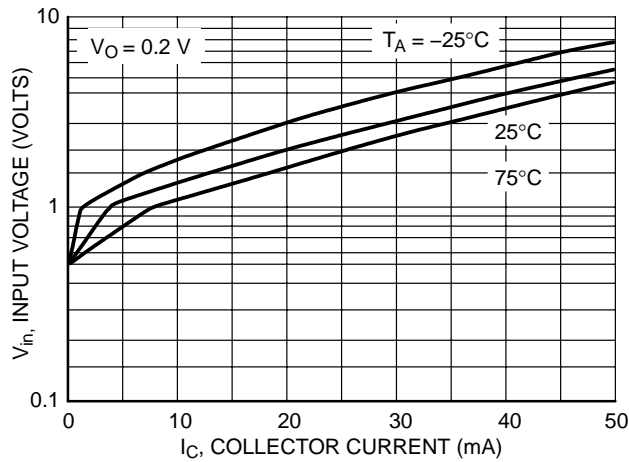

Figure 21. Input Voltage vs. Output Current

MMUN2211LT1 Series

TYPICAL ELECTRICAL CHARACTERISTICS MMUN2232LT1

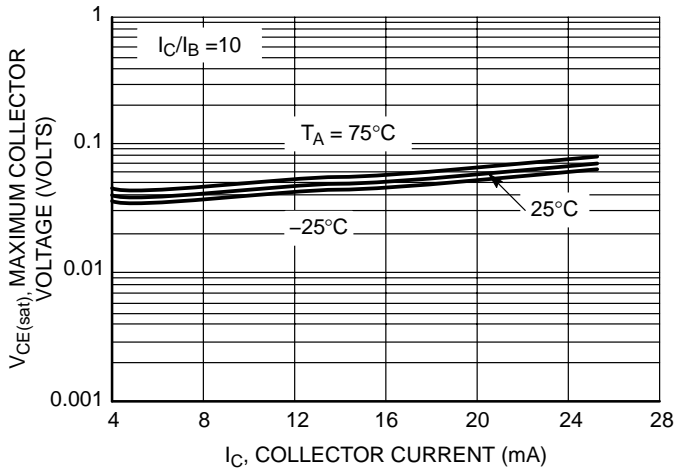

Figure 22. $V_{CE(sat)}$ vs. I_C

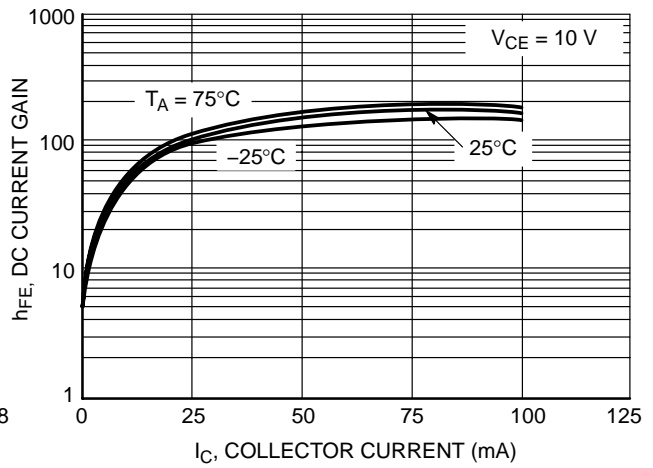

Figure 23. DC Current Gain

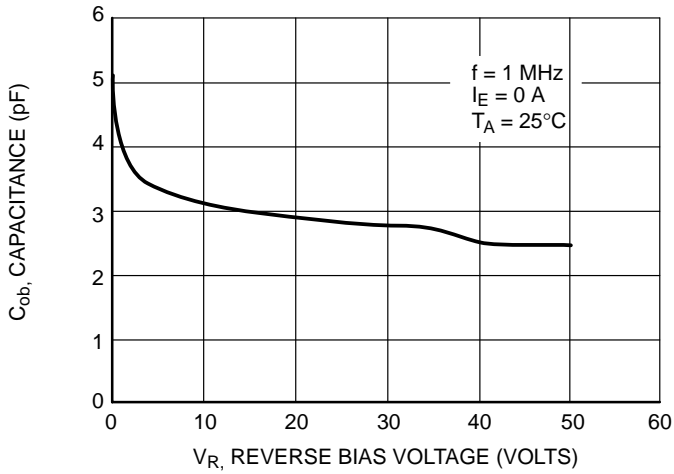

Figure 24. Output Capacitance

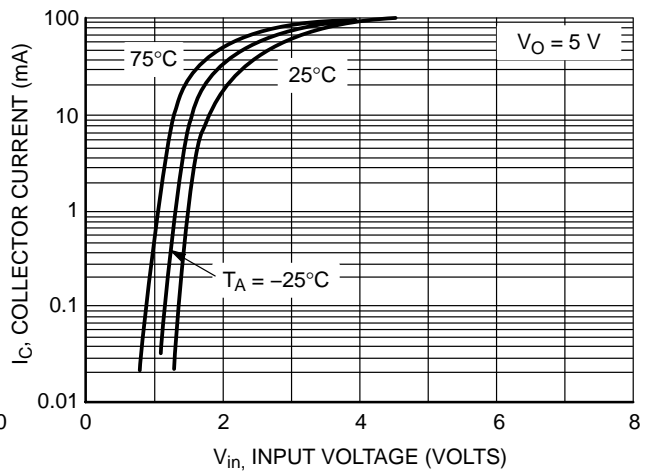

Figure 25. Output Current vs. Input Voltage

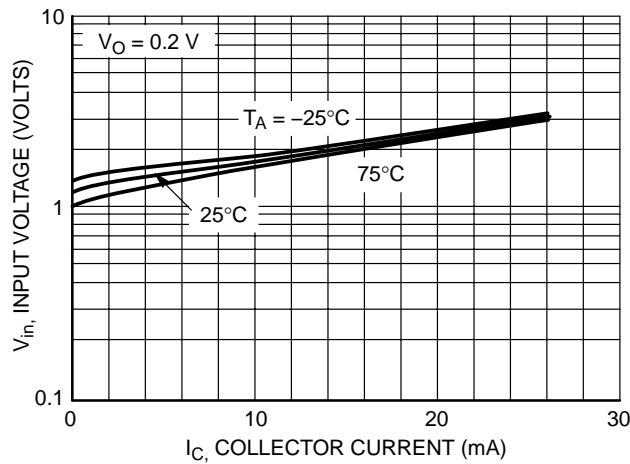

Figure 26. Output Voltage vs. Input Current

MMUN2211LT1 Series

TYPICAL ELECTRICAL CHARACTERISTICS MMUN2233LT1

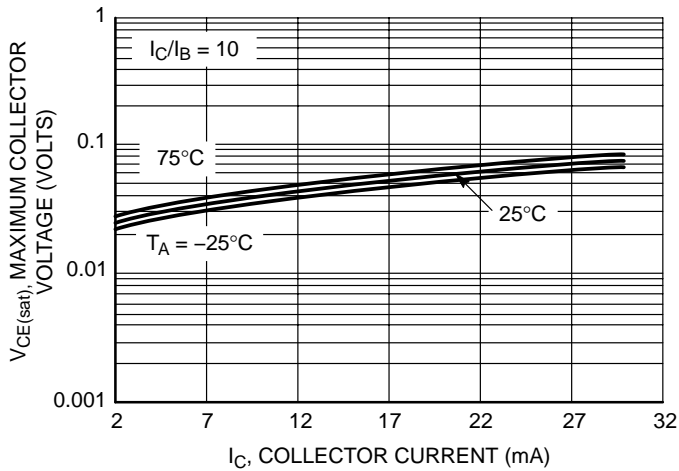

Figure 27. $V_{CE(sat)}$ vs. I_C

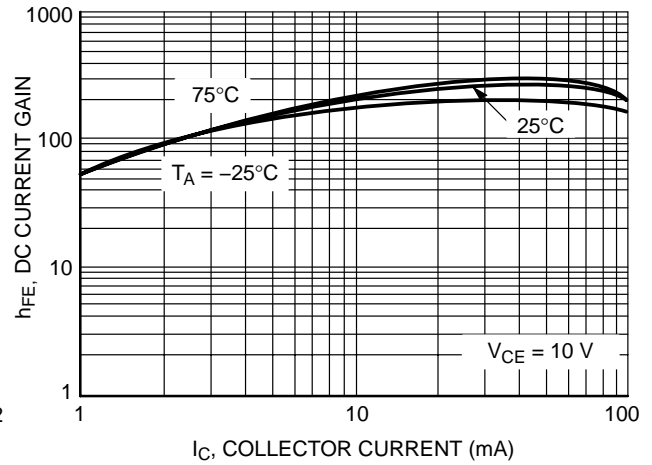

Figure 28. DC Current Gain

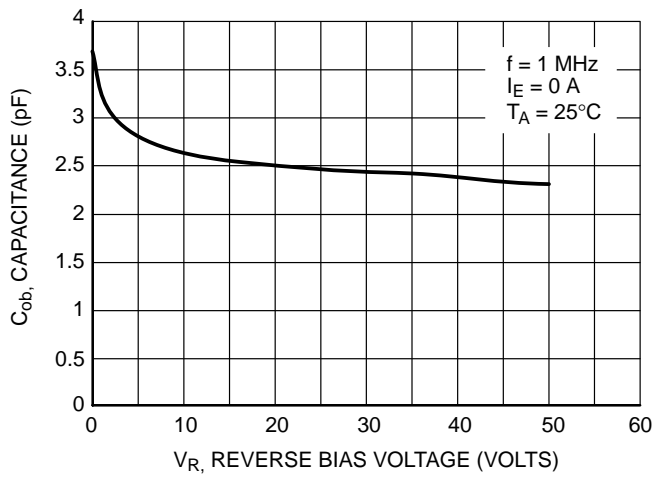

Figure 29. Output Capacitance

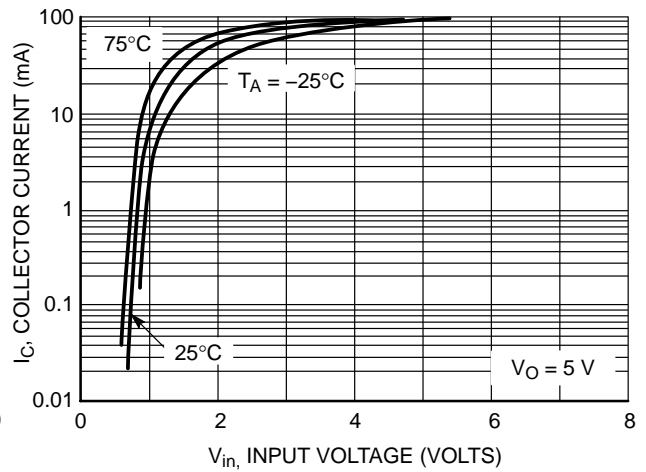

Figure 30. Output Current vs. Input Voltage

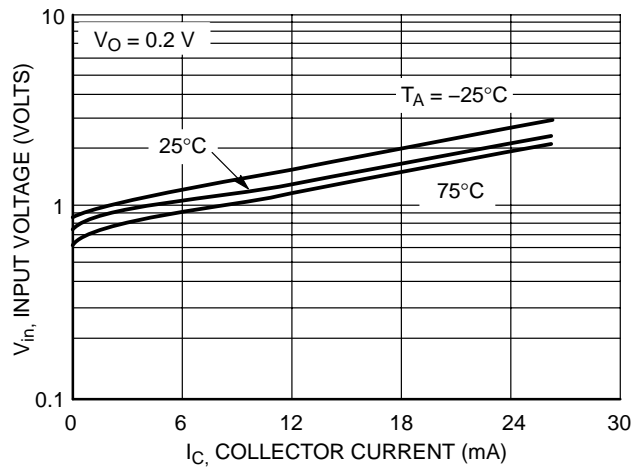

Figure 31. Input Voltage vs. Output Current

MMUN2211LT1 Series

TYPICAL APPLICATIONS FOR NPN BRTs

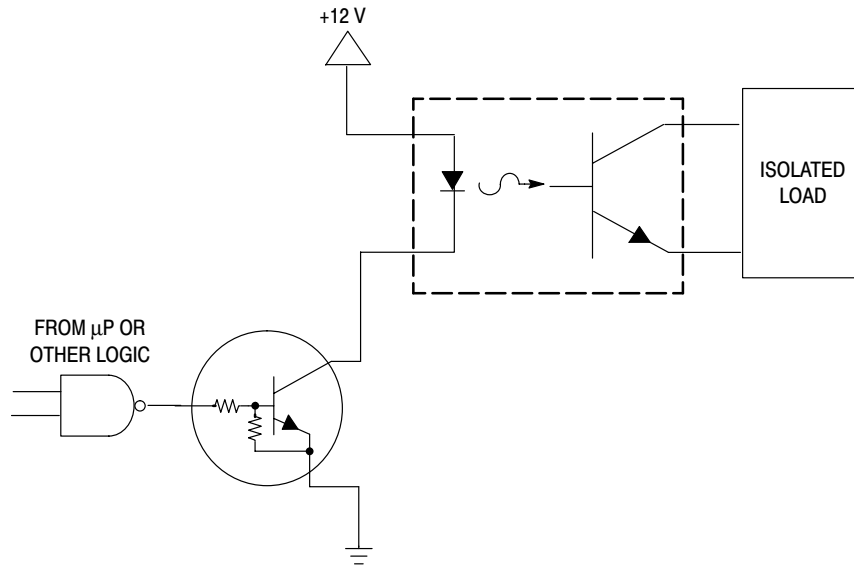

Figure 32. Level Shifter: Connects 12 or 24 Volt Circuits to Logic

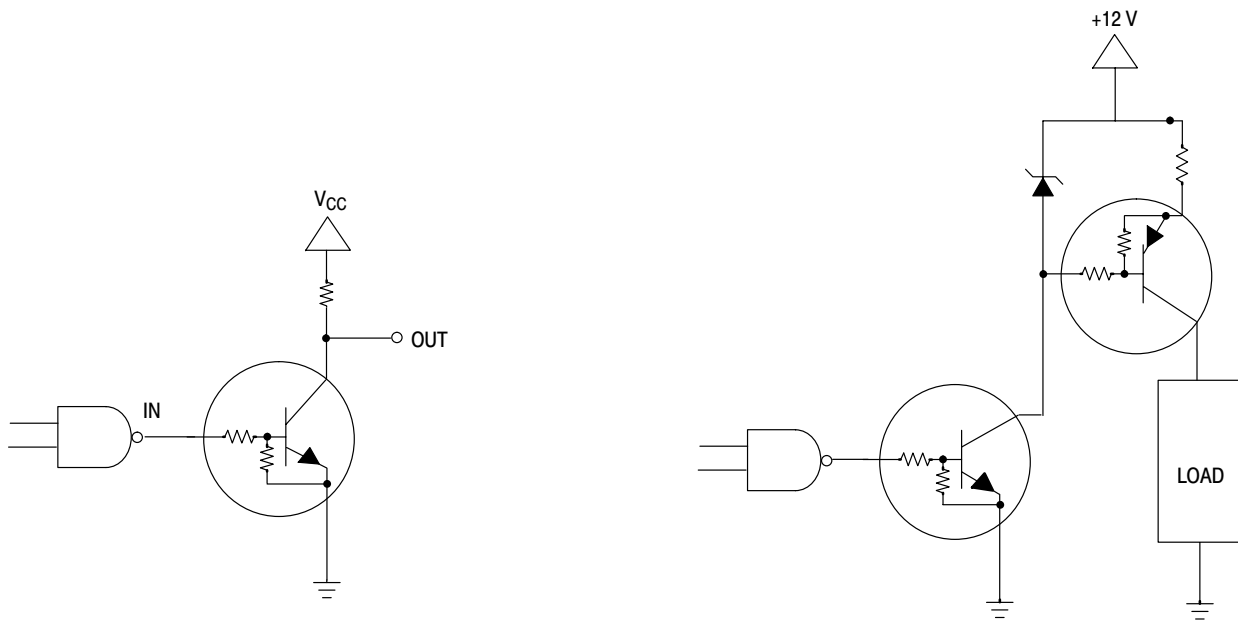

Figure 33. Open Collector Inverter: Inverts the Input Signal

Figure 34. Inexpensive, Unregulated Current Source

MMUN2211LT1 Series

PACKAGE DIMENSIONS

SOT-23
TO-236AB
CASE 318-08
ISSUE AI

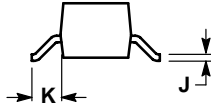
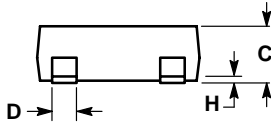
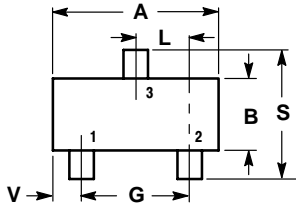

NOTES:

1. DIMENSIONING AND TOLERANCING PER ANSI Y14.5M, 1982.
2. CONTROLLING DIMENSION: INCH.
3. MAXIMUM LEAD THICKNESS INCLUDES LEAD FINISH THICKNESS. MINIMUM LEAD THICKNESS IS THE MINIMUM THICKNESS OF BASE MATERIAL.
4. 318-03 AND -07 OBSOLETE, NEW STANDARD 318-08.

DIM	INCHES		MILLIMETERS	
	MIN	MAX	MIN	MAX
A	0.1102	0.1197	2.80	3.04
B	0.0472	0.0551	1.20	1.40
C	0.0350	0.0440	0.89	1.11
D	0.0150	0.0200	0.37	0.50
G	0.0701	0.0807	1.78	2.04
H	0.0005	0.0040	0.013	0.100
J	0.0034	0.0070	0.085	0.177
K	0.0140	0.0285	0.35	0.69
L	0.0350	0.0401	0.89	1.02
S	0.0830	0.1039	2.10	2.64
V	0.0177	0.0236	0.45	0.60

STYLE 6:

1. BASE
2. EMITTER
3. COLLECTOR

SOLDERING FOOTPRINT*

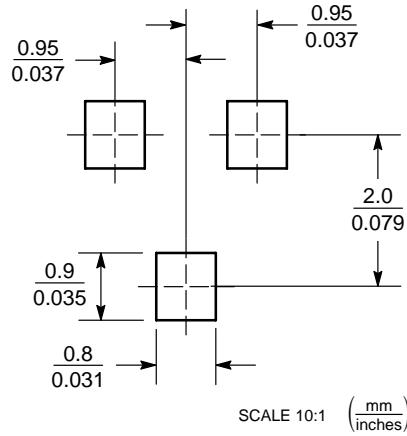

*For additional information on our Pb-Free strategy and soldering details, please download the ON Semiconductor Soldering and Mounting Techniques Reference Manual, SOLDERRM/D.

MMUN2211LT1 Series

ON Semiconductor and  are registered trademarks of Semiconductor Components Industries, LLC (SCILLC). SCILLC reserves the right to make changes without further notice to any products herein. SCILLC makes no warranty, representation or guarantee regarding the suitability of its products for any particular purpose, nor does SCILLC assume any liability arising out of the application or use of any product or circuit, and specifically disclaims any and all liability, including without limitation special, consequential or incidental damages. "Typical" parameters which may be provided in SCILLC data sheets and/or specifications can and do vary in different applications and actual performance may vary over time. All operating parameters, including "Typicals" must be validated for each customer application by customer's technical experts. SCILLC does not convey any license under its patent rights nor the rights of others. SCILLC products are not designed, intended, or authorized for use as components in systems intended for surgical implant into the body, or other applications intended to support or sustain life, or for any other application in which the failure of the SCILLC product could create a situation where personal injury or death may occur. Should Buyer purchase or use SCILLC products for any such unintended or unauthorized application, Buyer shall indemnify and hold SCILLC and its officers, employees, subsidiaries, affiliates, and distributors harmless against all claims, costs, damages, and expenses, and reasonable attorney fees arising out of, directly or indirectly, any claim of personal injury or death associated with such unintended or unauthorized use, even if such claim alleges that SCILLC was negligent regarding the design or manufacture of the part. SCILLC is an Equal Opportunity/Affirmative Action Employer. This literature is subject to all applicable copyright laws and is not for resale in any manner.

PUBLICATION ORDERING INFORMATION

LITERATURE FULFILLMENT:

Literature Distribution Center for ON Semiconductor
P.O. Box 5163, Denver, Colorado 80217 USA

Phone: 303-675-2175 or 800-344-3860 Toll Free USA/Canada

Fax: 303-675-2176 or 800-344-3867 Toll Free USA/Canada

Email: orderlit@onsemi.com

N. American Technical Support: 800-282-9855 Toll Free
USA/Canada

Japan: ON Semiconductor, Japan Customer Focus Center
2-9-1 Kamimeguro, Meguro-ku, Tokyo, Japan 153-0051
Phone: 81-3-5773-3850

ON Semiconductor Website: <http://onsemi.com>

Order Literature: <http://www.onsemi.com/litorder>

For additional information, please contact your
local Sales Representative.