

# MN3206

## 128-STAGE LOW VOLTAGE OPERATION LOW NOISE BBD

### General description

The MN3206 is a 128-stage low voltage operation ( $V_{DD} = 5V$ ) BBD that provides a signal delay of up to 6.4ms and is suitable for use as reverberation effect of audio equipments operated by low voltage such as portable stereo and radio cassette recorder.

### Features

- Variable delay of audio signals: 0.32ms ~ 6.4ms.
- Wide power supply voltage: 4 ~ 10V.
- No insertion loss:  $L_i = 0dB$  typ.
- Wide dynamic range:  $S/N = 83dB$  typ.
- Low distortion:  $THD = 0.3\%$  typ. ( $V_i = 0.25V_{rms}$ )
- Clock frequency range: 10KHz ~ 200KHz.
- N channel silicon gate process.
- 8-Lead Dual-In-Line Plastic Package.

### Applications

- Reverberation and echo effects of audio equipments such as radio cassette recorder, car radio, portable radio, portable stereo, echo microphone and pre-taped musical accompaniment (Karaoke), etc.
- Sound effect in electronic musical instruments.
- Variable or fixed delay of analog signals.

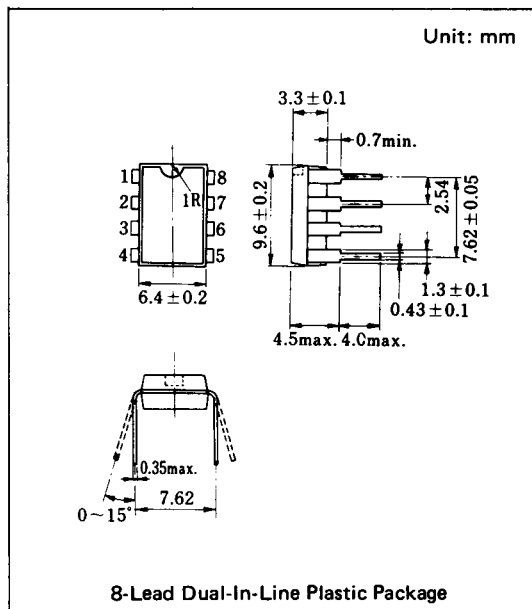

### Block Diagram

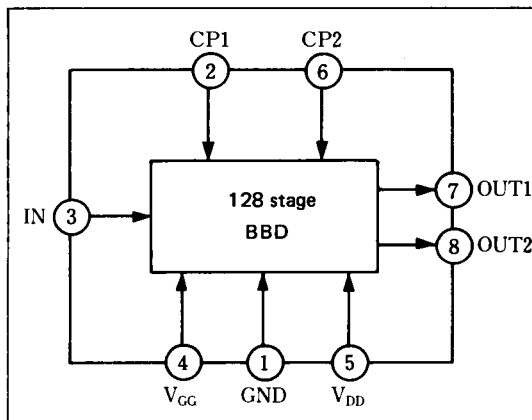

### Quick Reference Data

Item	Symbol	Value	Unit
Supply Voltage	$V_{DD}, V_{GG}$	+ 5, $\frac{1}{18} V_{DD}$	V
Signal Delay Time	$t_D$	0.32~6.4	ms
Total Harmonic Distortion	THD	0.3	%
Signal to Noise Ratio	S/N	83	dB

■ Absolute Maximum Ratings (Ta = 25°C)

Item	Symbol	Ratings	Unit
Terminal Voltage	V <sub>DD</sub> , V <sub>GG</sub> , V <sub>CP</sub> , V <sub>I</sub>	-0.3~+11	V
Output Voltage	V <sub>O</sub>	-0.3~+11	V
Operating Temperature	T <sub>opr</sub>	-20~+70	°C
Storage Temperature	T <sub>stg</sub>	-55~+125	°C

■ Operating Condition (Ta = 25°C)

Item	Symbol	Conditon	Min.	Typ.	Max.	Unit
Drain Supply Voltage	V <sub>DD</sub>		+4	+5	+10	V
Gate Supply Voltage	V <sub>GG</sub>			$\frac{14}{15}V_{DD}$		V
Clock Voltage "H" Level	V <sub>CPH</sub>			V <sub>DD</sub>		V
Clock Voltage "L" Level	V <sub>CPL</sub>		0		+1	V
Clock Frequency	f <sub>CP</sub>		10		200	kHz
Clock Pulse Width *1	t <sub>CPW</sub>				0.5T *2	
Clock Rise Time *1	t <sub>CPr</sub>				500	ns
Clock Fall Time *1	t <sub>CPf</sub>				500	ns
Clock Input Capacitance	C <sub>CP</sub>				700	pF
Clock Cross Point *1	V <sub>X</sub>		0		0.3V <sub>CPH</sub>	V

■ Electrical Characteristics (Ta=25°C, V<sub>DD</sub>=V<sub>CPH</sub>=5V, V<sub>CPL</sub>=0V, V<sub>GG</sub>= $\frac{14}{15}V_{DD}$ , R<sub>L</sub>=100kΩ)

Item	Symbol	Condition	Min.	Typ.	Max.	Unit
Signal Delay Time	t <sub>D</sub>		0.32		6.4	ms
Input Signal Frequency	f <sub>i</sub>	f <sub>CP</sub> = 40kHz, Output -3dB down	12			kHz
Input Signal Swing	V <sub>i</sub>	THD=2.5%	0.6			Vrms
Insertion Loss	L <sub>i</sub>	f <sub>CP</sub> =40kHz, f <sub>i</sub> =1kHz	-4	0	4	dB
Total Harmonic Distortion	THD	f <sub>CP</sub> =40kHz, f <sub>i</sub> =1kHz, V <sub>i</sub> =0.25Vrms		0.3	2.5	%
Noise Voltage	V <sub>no</sub>	f <sub>CP</sub> = 100kHz, Weighted by "A" curve			0.1	mVrms
Signal to Noise Ratio	S/N			83		dB

\*1 Clock Pulse Waveforms

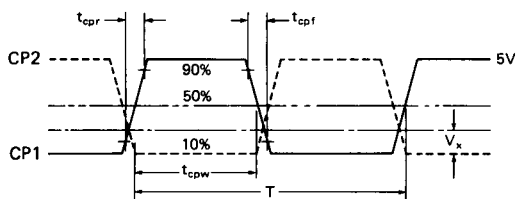

\*2 T = 1/f<sub>CP</sub> (Clock Period)

■ Terminal Assignments

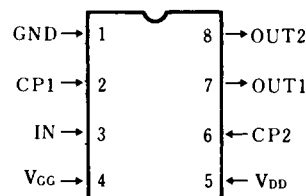

(Top View)

■ Circuit Diagram

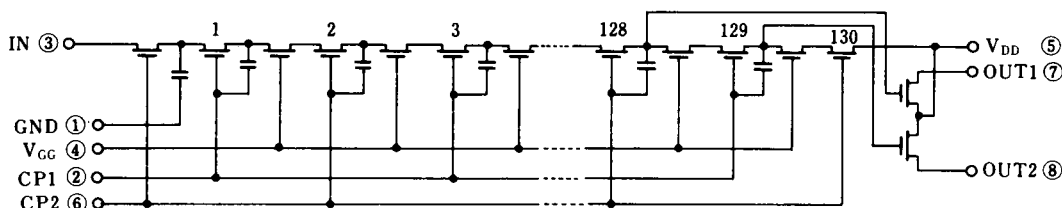

Typical Electrical Characteristic Curves

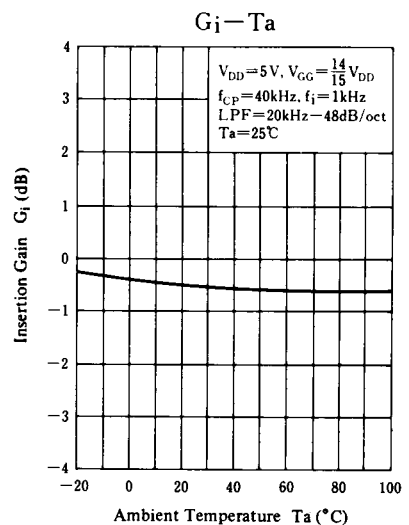
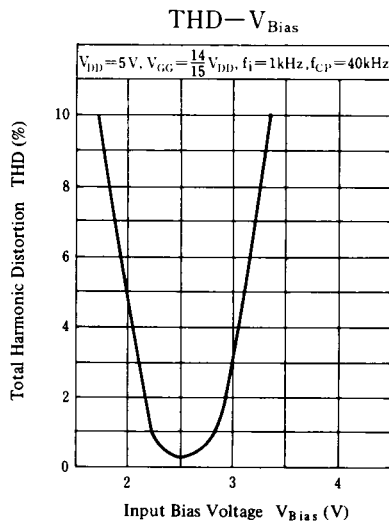
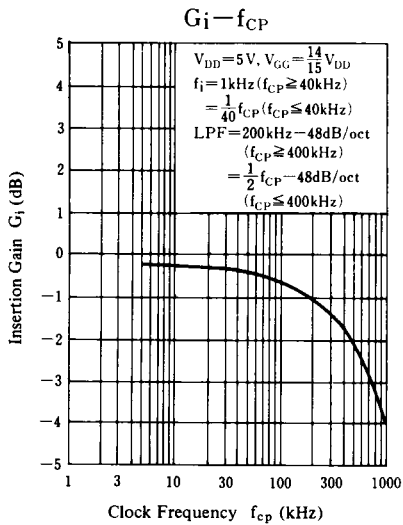
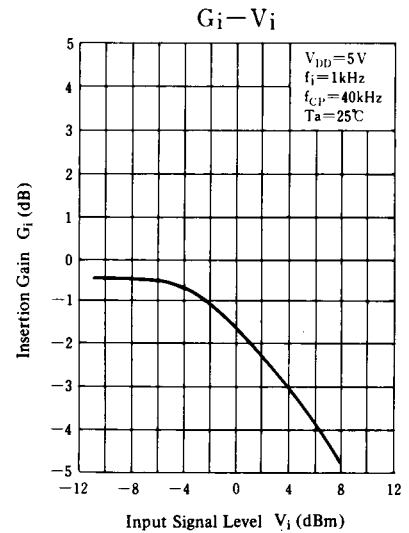
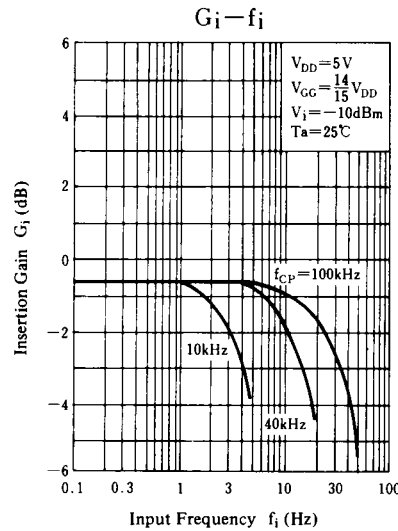
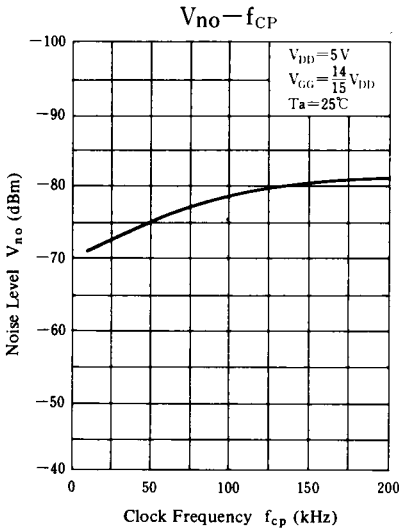
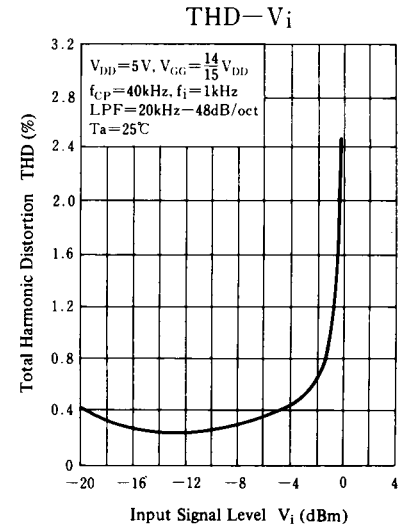
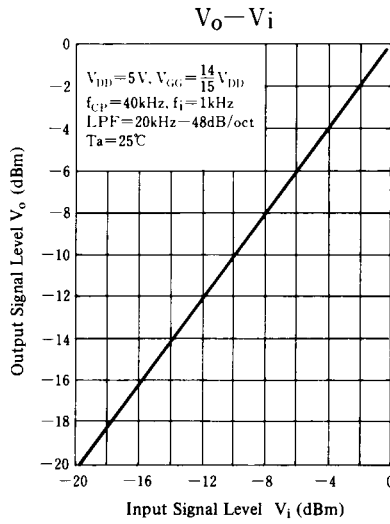
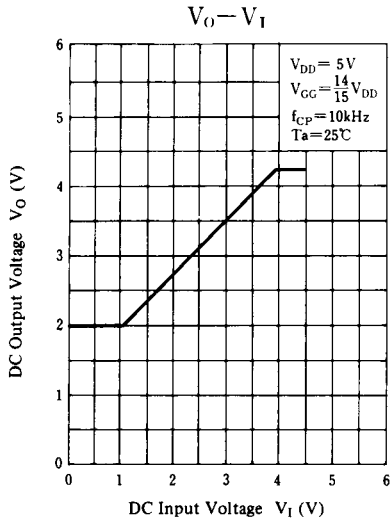

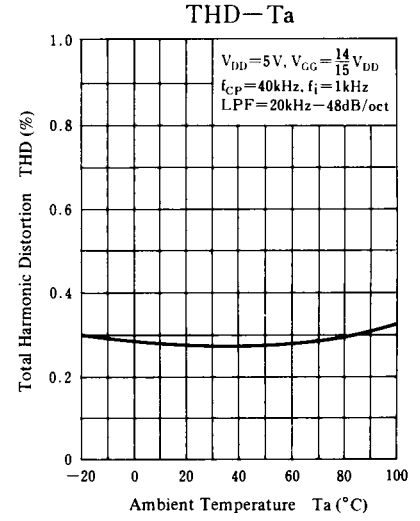
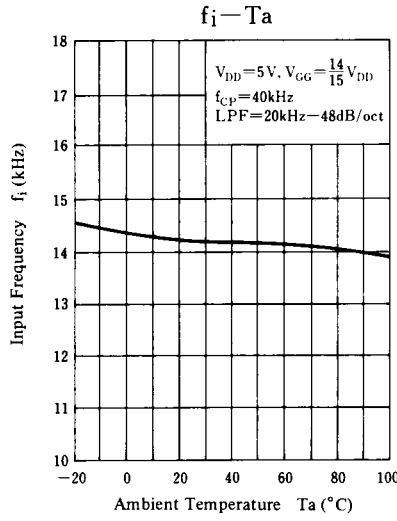
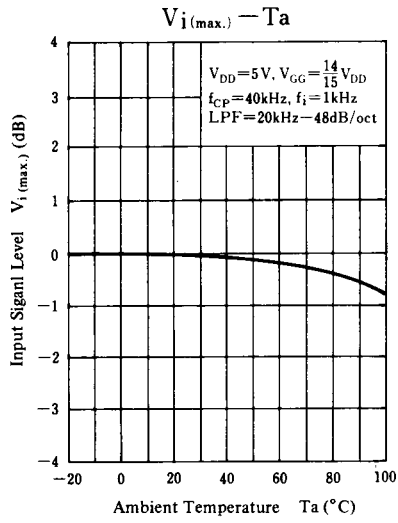

**Supply Voltage Characteristics**

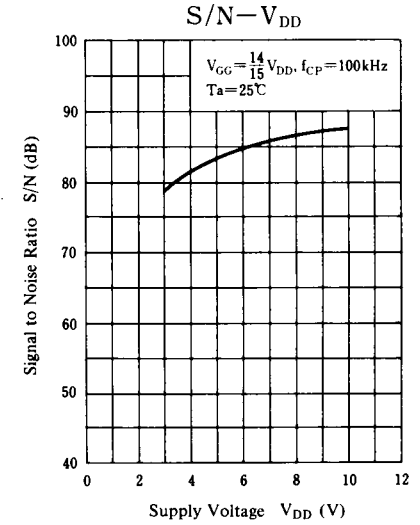
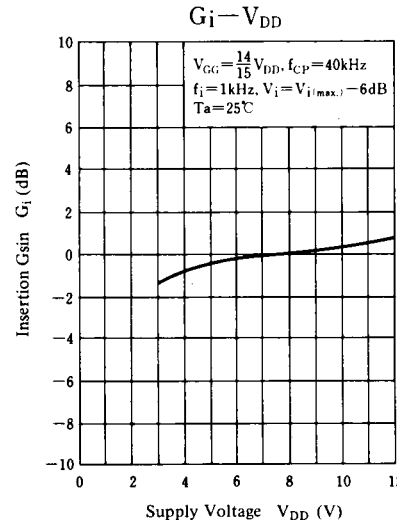
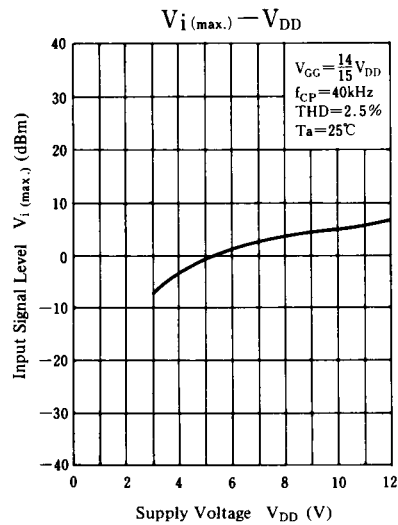
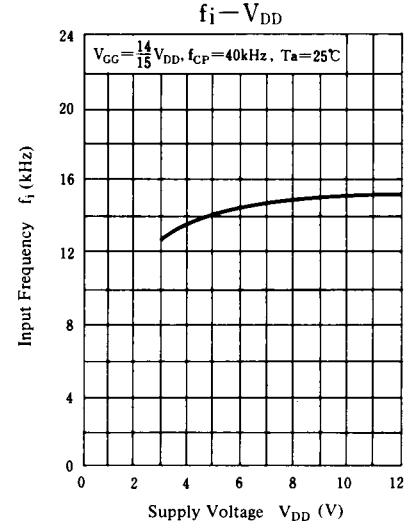
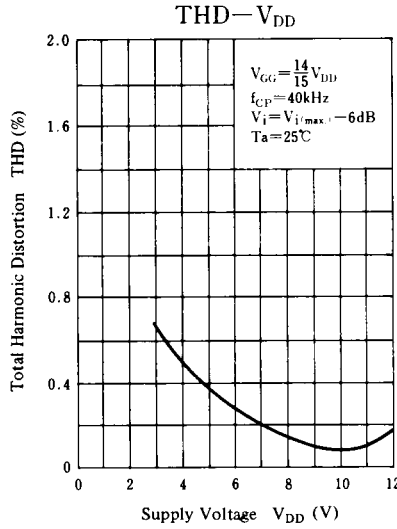
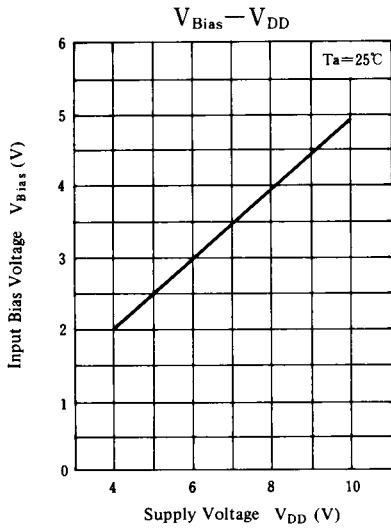

■ Application Circuit

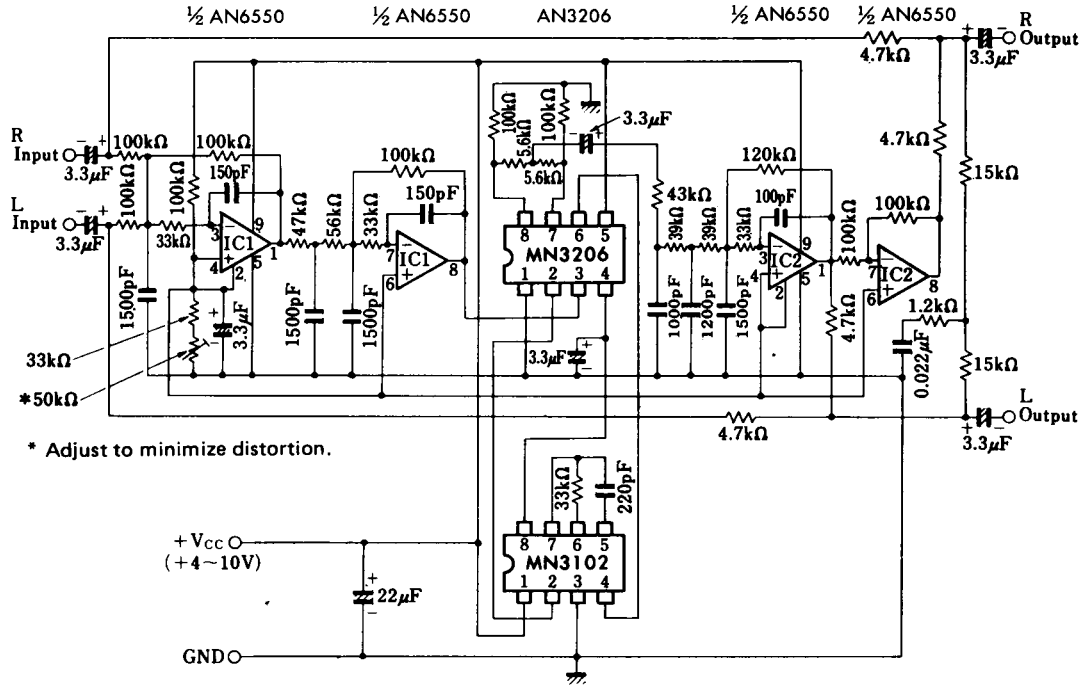

Vibrato and/or chorus effects Generation Circuit