

# Ultra-Fast-Recovery Rectifier Diodes 300V

$t_{rr} \textcircled{1}$ :  $I_F/I_R (=I_F)$  90% Recovery Point  
 (ex.  $I_F/I_R = 100\text{mA}/100\text{mA}$  90% Recovery Point)  
 $t_{rr} \textcircled{2}$ :  $I_F/I_R (=2I_F)$  75% Recovery Point  
 (ex.  $I_F/I_R = 100\text{mA}/200\text{mA}$  75% Recovery Point)

$V_{RM}$ (V)	Package	Part Number	$I_F$ (AV) (A)	$I_{FSM}$ (A)	$T_j$ (°C)	$T_{stg}$ (°C)	$V_F$ (V) max	$I_F$ (A)	$I_R$ ( $\mu$ A)	$I_R$ (H) (mA)	$T_a$ (°C)	$t_{rr} \textcircled{1}$ (ns)		$t_{rr} \textcircled{2}$ (ns)		$R_{th(j-\theta)}$ $R_{th(j-c)}$ (°C/W)	Mass (g)	Fig. No.	Page where characteristic curve is shown
				50Hz Half-cycle Sinewave Single Shot					$V_R = V_{RM}$ max	$V_R = V_{RM}$ max		$I_F/I_{FP}$ (mA)	$I_F/I_{FP}$ (mA)						
300	Surface Mount	SFPX-63	2.0	20	-40 to +150	1.3	2	50	3	150	30	100/100	25	100/200	20	0.07	1	—	
	Surface Mount Center-tap	MPX-2103	10.0	65	-40 to +150	1.3	5.0	50	15	150 ( $T_j$ )	30	100/100	25	100/200	2.5	1.04	5	81	
	Frame-2Pin	FML-G13S	5.0	70	-40 to +150	1.3	5.0	100	0.2	100	50	100/100	35	100/200	4.0	2.1	2	72	
	Center-tap	FMG-13S, R	5.0	35	-40 to +150	1.8	2.5	500	1.5	100	100	100/100	50	100/200	4.0	2.1	3	74	
		FML-13S	5.0	40	-40 to +150	1.3	2.5	50	0.1	100	50	100/100	35	100/200	4.0	2.1		76	
		FMG-23S, R	10.0	65	-40 to +150	1.8	5.0	500	1.5	100	100	100/100	50	100/200	4.0	2.1		75	
		FML-23S	10.0	70	-40 to +150	1.3	5.0	100	0.5	100	50	100/100	35	100/200	4.0	2.1		76	
		FMX-23S	10.0	65	-40 to +150	1.3	5.0	50	15	150	30	100/100	25	100/200	4.0	2.1		—	
		FMX-2203	20.0	100	-40 to +150	1.3	10.0	100	30	150	30	500/500	25	500/1000	4.0	2.1		81	
	Center-tap	FMG-33S, R	20.0	150	-40 to +150	1.8	10.0	1000	5	100	100	100/100	50	100/200	2.0	5.5	4	77	
FML-33S		20.0	100	-40 to +150	1.3	10.0	200	1	100	50	500/500	35	500/1000	2.0	5.5	78			
FMX-33S		20.0	100	-40 to +150	1.3	10.0	100	30	150	30	500/500	25	500/1000	2.0	5.5	—			

## External Dimensions Flammability: UL94V-0 or Equivalent (Unit: mm)

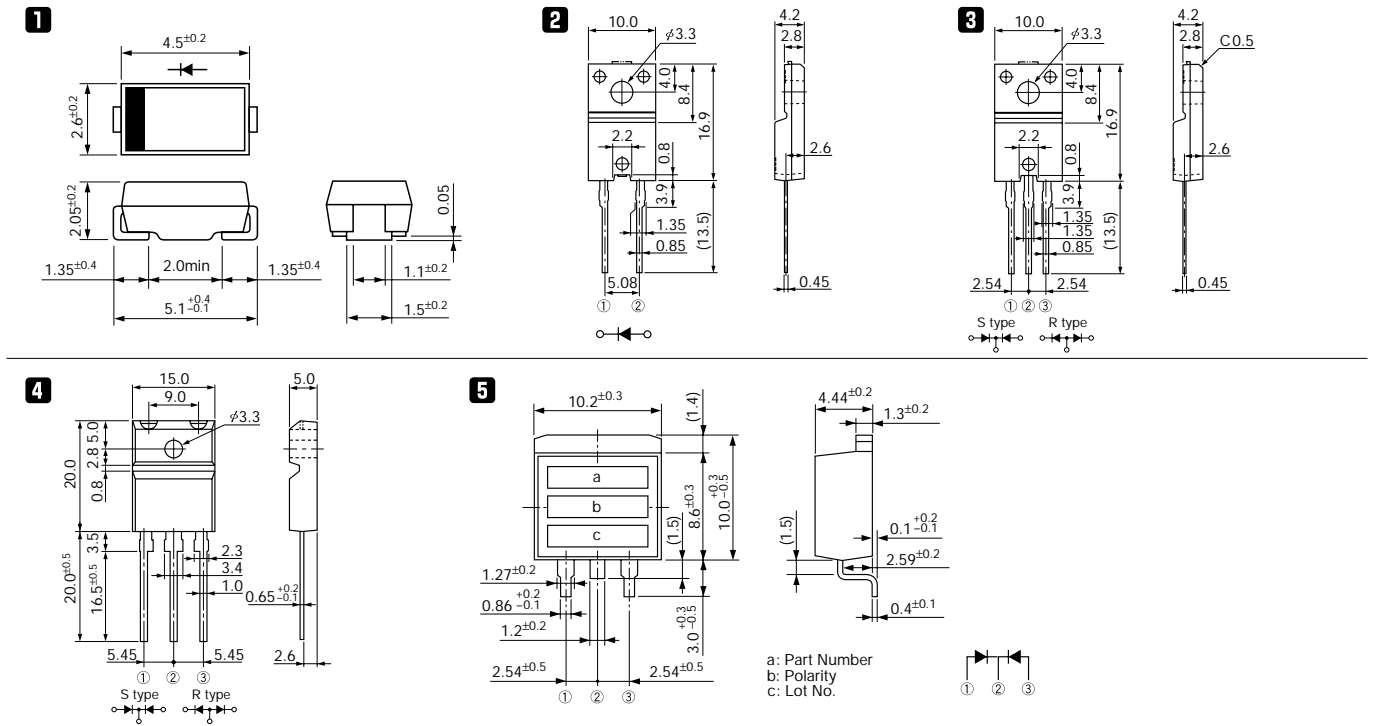

# Ultra-Fast-Recovery Rectifier Diodes

## FMX-2203

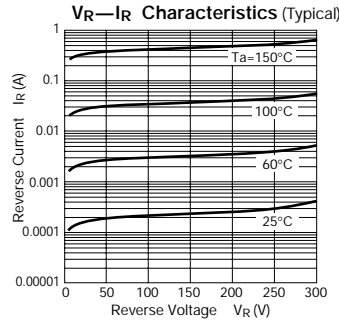
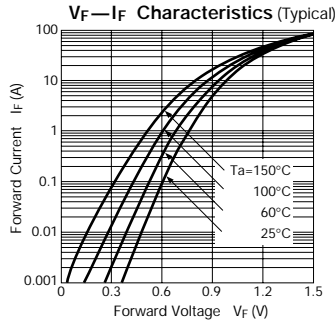
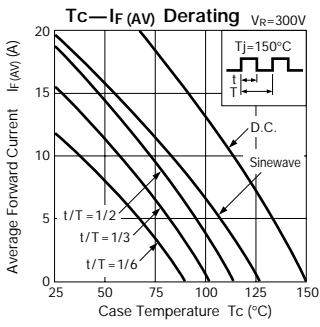

## SFPL-64

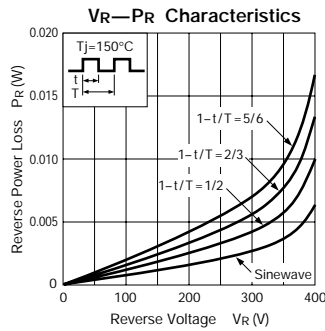
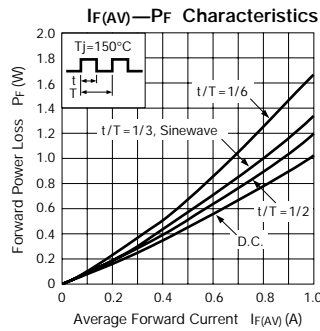
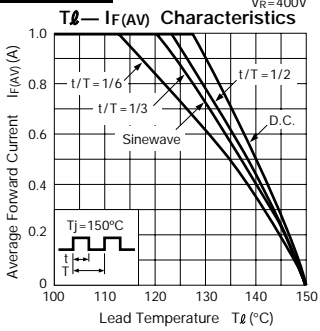

## MPX-2103

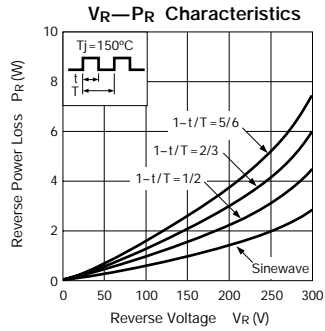
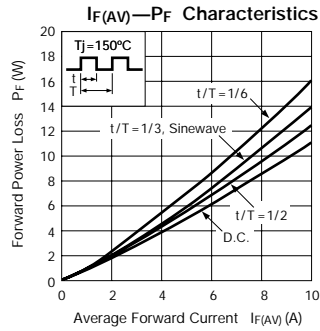
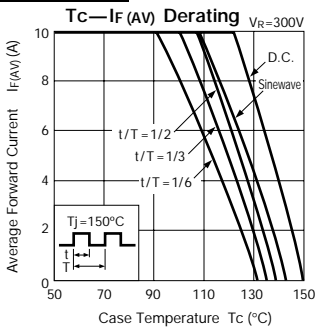

## FMW-2204

