

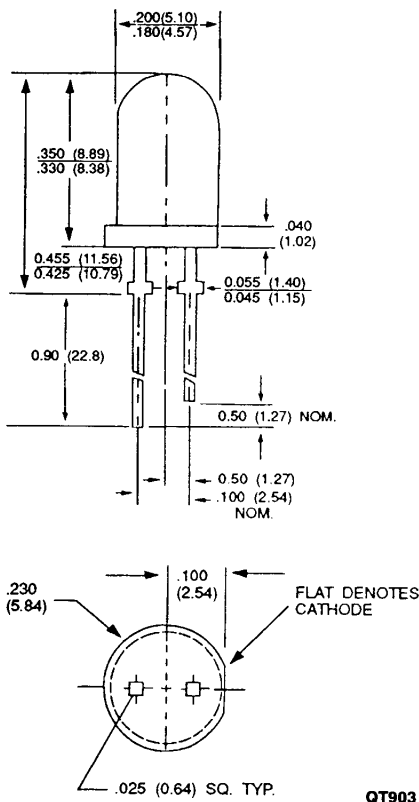

## INTEGRATED T-1 3/4 RESISTOR LAMPS 5 VOLT and 12 VOLT SERIES

### RED MR3050/MR3051 TINTED HIGH EFFICIENCY RED MR3750/MR3751 TINTED YELLOW MR3350/MR3351 TINTED HIGH EFFICIENCY GREEN MR3450/MR3451 TINTED

#### PACKAGE DIMENSIONS



QT903

#### DESCRIPTION

This group of T-1 3/4 size LED lamps contain integral resistors. Operation at 5 volts (MR3X50 Part Nos.) or 12 volts (MR3X51 Part Nos.) is possible without the use of external current limiting resistors. Color tinted, diffused epoxy packages are used for all the lamps in this group.

#### FEATURES

- Integral Current Limiting Resistor  
(No external resistor required)
- TTL Compatible
- Operate with 5 Volt & 12 Volt Supplies
- All Colors - Red, HER, Yellow, Green
- Wide Viewing Angle
- Solid-State Reliability

#### NOTES:

1. ALL TOLERANCES, UNLESS OTHERWISE SPECIFIED: .XXX ± 010
2. ALL DIMENSIONS IN INCHES (MILLIMETERS)

#### PHYSICAL CHARACTERISTICS

TYPE	SOURCE COLOR	LENS COLOR
MR3050	Red	Red Diffused
MR3051	Red	Red Diffused
MR3750	High Efficiency Red	Red Diffused
MR3751	High Efficiency Red	Red Diffused
MR3350	Yellow	Yellow Diffused
MR3351	Yellow	Yellow Diffused
MR3450	High Efficiency Green	Green Diffused
MR3451	High Efficiency Green	Green Diffused



## INTEGRATED T-1 3/4 RESISTOR LAMPS 5 VOLT and 12 VOLT SERIES

<b>ELECTRO-OPTICAL CHARACTERISTICS</b> (TA = 25°C Unless Otherwise Specified)											
		RED						HIGH EFFICIENCY RED		UNITS	TEST CONDITION
PARAMETER	SYMBOL	MR3050		MR3051		MR3750		MR3751			
		MIN.	TYP.	MAX.	MIN.	TYP.	MAX.	MIN.	TYP.	MAX.	
Luminous Intensity	I <sub>v</sub>			1.0	2.0			1.5	4.0		mcd V <sub>f</sub> =12 V
Luminous Intensity	I <sub>v</sub>	1.0	2.0					1.5	4.0		mcd V <sub>f</sub> =5 V
Total Viewing Angle	2θ <sub>1/2</sub>	60		60		60		60			Deg
Peak Wavelength	λ <sub>p</sub>	655		655		635		635			nm
Spectral Line Halfwidth	Δλ <sub>1/2</sub>	24		24		40		40			nm
Forward Current 12V Devices	I <sub>f</sub>								13	20	mA V <sub>f</sub> =12 V
Forward Current 5V Devices	I <sub>f</sub>	13	20			13	20	10	15		mA V <sub>f</sub> =5 V
Reverse Breakdown Voltage	V <sub>r</sub>	5.0		5.0		5.0		5.0			I <sub>r</sub> =100μA

<b>ELECTRO-OPTICAL CHARACTERISTICS</b> (TA = 25°C Unless Otherwise Specified)											
		YELLOW				HIGH EFFICIENCY GREEN				UNITS	TEST CONDITION
PARAMETER	SYMBOL	MR3350		MR3351		MR3450		MR3451			
		MIN.	TYP.	MAX.	MIN.	TYP.	MAX.	MIN.	TYP.	MAX.	
Luminous Intensity	I <sub>v</sub>			1.5	4.0			1.5	4.0		mcd V <sub>f</sub> =12 V
Luminous Intensity	I <sub>v</sub>	1.5	4.0					1.5	4.0		mcd V <sub>f</sub> =5 V
Total Viewing Angle	2θ <sub>1/2</sub>	60		60		60		60			Deg
Peak Wavelength	λ <sub>p</sub>	583		583		565		565			nm
Spectral Line Halfwidth	Δλ <sub>1/2</sub>	36		36		28		28			nm
Forward Current 12V Devices	I <sub>f</sub>				13	20			13	20	mA V <sub>f</sub> =12 V
Forward Current 5V Devices	I <sub>f</sub>	10	15					12	15		mA V <sub>f</sub> =5 V
Reverse Breakdown Voltage	V <sub>r</sub>	5.0		5.0		5.0		5.0			I <sub>r</sub> =100μA

<b>ABSOLUTE MAXIMUM RATINGS</b> (TA = 25°C Unless Otherwise Specified)				
	RED/HER/YELLOW 5 VOLT LAMPS	RED/HER/YELLOW 12 VOLT LAMPS	GREEN 5 VOLT LAMPS	GREEN 12 VOLT LAMPS
DC Forward Voltage (TA=25°C)	7.5 Volts	15 Volts	7.5 Volts	15 Volts
Reverse Voltage (I <sub>r</sub> =100 μA)	5 Volts	5 Volts	5 Volts	5 Volts
Operating Temperature Range	-40°C to +85°C	-40°C to +85°C	-20°C to +85°C	-20°C to +85°C
Storage Temperature Range	-55°C to +100°C	-55°C to +100°C	-55°C to +100°C	-55°C to +100°C
Lead Soldering Temperature	260°C for 5 seconds			

**TYPICAL ELECTRO-OPTICAL CHARACTERISTIC CURVES**

(TA = 25°C Unless Otherwise Specified)

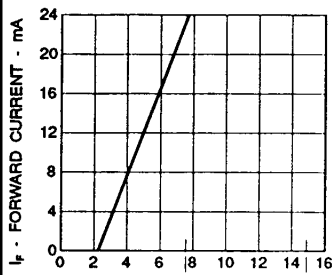

Fig. 1. Forward Current vs. Applied Forward Voltage 5 Volt Devices

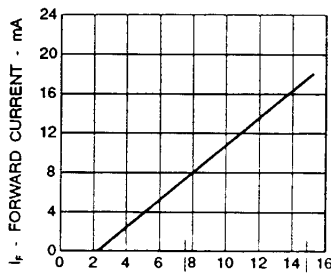

Fig. 2. Forward Current vs. Applied Forward Voltage 12 Volt Devices

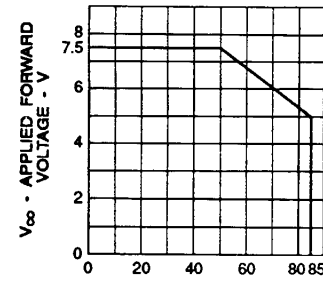

Fig. 3. Maximum Allowed Applied Forward Voltage vs. Ambient Temperature  
RθJA = 175°C/W 5 Volt Devices

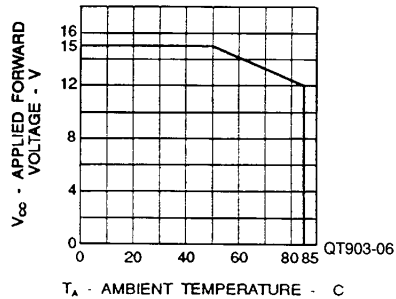

Fig. 4. Maximum Allowed Applied Forward Voltage vs. Ambient Temperature  
RθJA = 175°C/W 12 Volt Devices

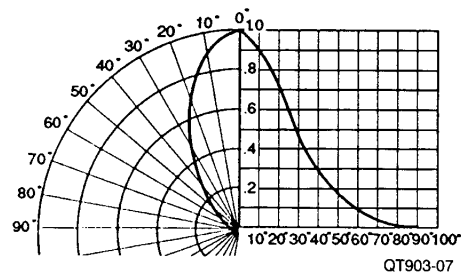

Fig. 5. Relative Luminous Intensity vs. Angular Displacement for T-1 3/4 Package

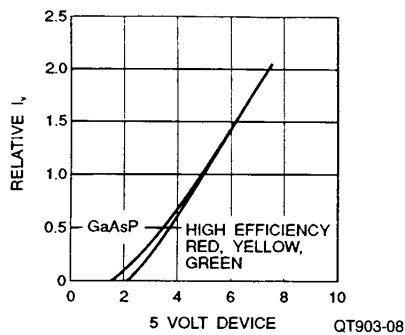

Fig. 6. Relative Luminous Intensity vs. Applied Forward Voltage 5 Volt Devices

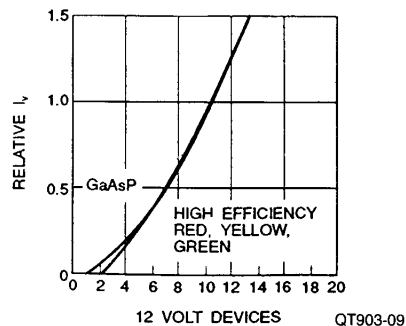

Fig. 7. Relative Luminous Intensity vs. Applied Forward Voltage 12 Volt Devices