

16-bit Stereo Audio DAC & Headphone Driver

Component Less, Low Cost

FEATURES

- Operation range: 2.7V~5.5V
- Excellent Power Supply Rejection Ratio(PSRR)
- No pop-noise
- Component less
- No zero crossing distortion
- Cost effective
- Fast setting time permits 2*, 4*, and 8* oversampling (serial input) or double speed operation at 4* oversampling
- Compatible with most of the Japanese input formats; time multiplexed, two's complement, TTL input level
- Cost efficient
- Housed in 8 pin SOP package

APPLICATIONS

- Multimedia system, MP3, PDA, Portable Digital Audio.

DESCRIPTION

The MS6331 is an integrated 16-bit voltage-output Digital-to-Analog Converter (DAC) and class AB stereo headphone driver. The MS6331 is with the excellent Power Supply Rejection Ratio(PSRR). It is fabricated in a CMOS process and features extremely low power dissipation, small package size and easy application. The accuracy of the matched coarse current sources, combined with the unique symmetrical decoding method, preclude zero-crossing distortion and ensures high quality audio reproduction. These unique features, combined with its exceptional performance, make the MS6331 ideally suited for use in digital audio equipment.

BLOCK DIAGRAM

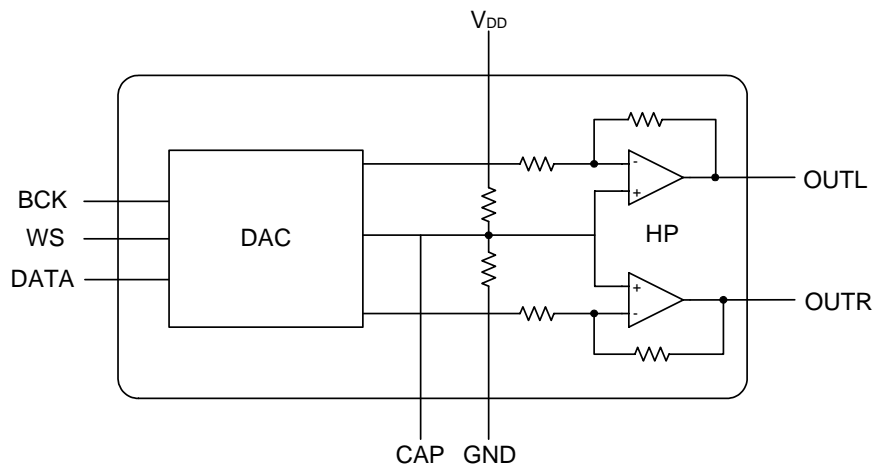

PIN CONFIGURATION

Symbol	Pin	Description
V _{DD}	1	Positive supply voltage
OUTL	2	Left channel output
OUTR	3	Right channel output
CAP	4	Capacitor
BCK	5	Bit clock input
WS	6	Word select input
DATA	7	Data input
GND	8	Ground

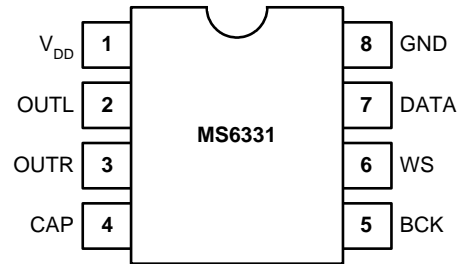

Pin 4 : Capacitor = 1uF~10uF

ORDERING INFORMATION

Package	Part number	Packaging Marking	Transport Media
8-Pin SOP	MS6331TR	MS6331	2.5k Units Tape and Reel
8-Pin SOP	MS6331U	MS6331	100 Units Tube
8-Pin SOP (lead free)	MS6331GTR	MS6331G	2.5k Units Tape and Reel
8-Pin SOP (lead free)	MS6331GU	MS6331G	100 Units Tube

ABSOLUTE MAXIMUM RATINGS

Symbol	Parameter	Rating	Unit
V _{DD}	Positive Supply Voltage	6	V
V _{ESD}	Electrostatic Handling	-3000 to 3000	V
T _{STG}	Storage Temperature Range	-65 to 150	°C
T _A	Operating Ambient Temperature Range	-40 to 85	°C
T _J	Maximum Junction Temperature	150	°C
T _S	Soldering Temperature, 10 seconds	260	°C
R _{THJA}	Thermal Resistance from Junction to Ambient in Free Air SOP8	210	°C/W

OPERATING RATINGS

Symbol	Parameter	Min	Typ	Max	Unit
V _{DD}	Supply Voltage	2.7	-	5.5	V

3.3V ELECTRICAL CHARACTERISTICS

($T_a=25^{\circ}\text{C}$, $V_{DD}=3.3\text{V}$, $V_{SS}=0\text{V}$, $f=1\text{kHz}$, $R_L=32\Omega$; unless otherwise specified)

Symbol	Parameter	Conditions	Min	Typ	Max	Unit
DC Characteristics						
V_{CAP}	Voltage at CAP		1.60	1.65	1.70	V
V_{DC}	Output DC level		1.60	1.65	1.70	V
V_{FS}	Full scale output voltage	$V_{FS}=0.023663 * 24 * V_{DD}$	-	1.87	-	V
I_Q	Quiescent current		-	3.6	4	mA
PSRR	Power supply rejection ratio	CAP=2.2uF (100Hz)	50	55	-	dB
		CAP=10uF (100Hz)	61	66	-	dB
CS	Channel separation		70	75	-	dB
AC Characteristics						
Res	Resolution		-	-	16	bits
THD+N	Total harmonic distortion plus noise		-	-60	-56	dB
			-	0.1	0.158	%
S/N	Signal-to-noise ratio		86	92	-	dB
Po	Maximum output power	(THD+N)/S < 0.1%	49	52	-	mW
Vo	Maximum output voltage swing	(THD+N)/S < 0.1%	2.5	2.6	-	Vpp

TYPICAL PERFORMANCE CHARACTERISTICS

($T_a=25^\circ\text{C}$, $R_L=32\Omega$, sampling rate=4fs; unless otherwise specified)

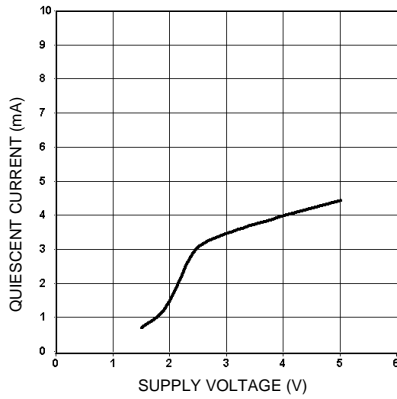

Quiescent current vs. supply voltage

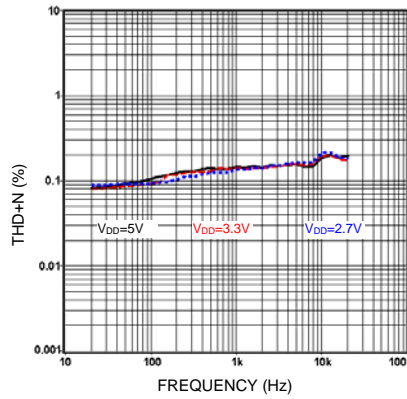

THD+N vs. frequency

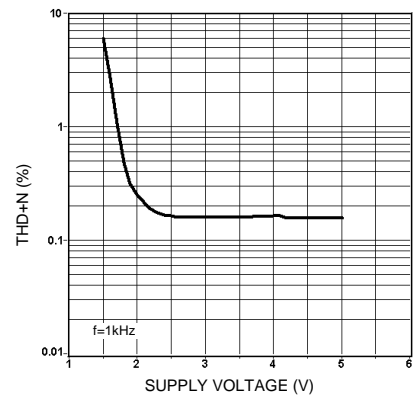

THD+N vs. supply voltage

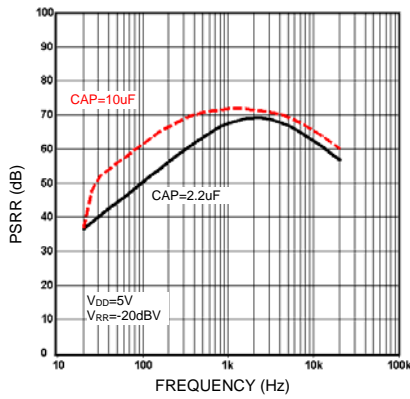

PSRR vs. frequency

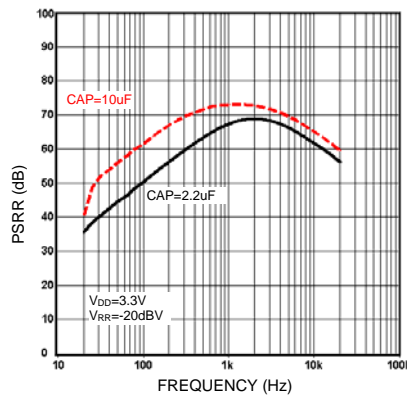

PSRR vs. frequency

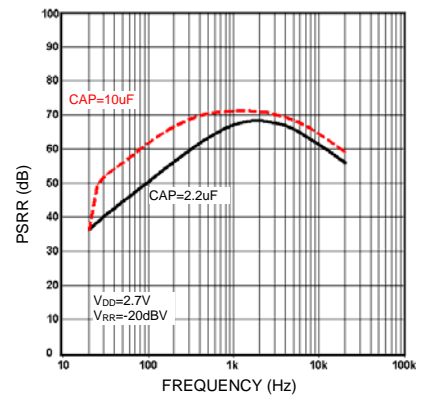

PSRR vs. frequency

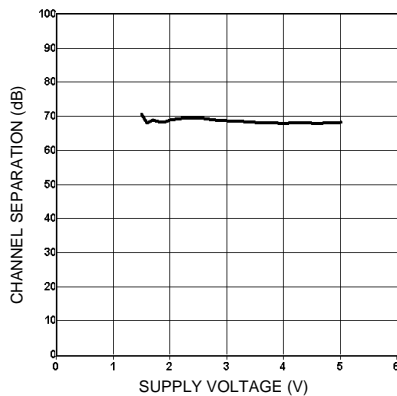

Channel separation vs. supply voltage

TIMING AND DATA FORMAT

The MS6331 accepts input serial data formats of 16-bit word length. Left and right data words are time multiplexed. The MSB must always be first. The format of data input is shown in Figs. 1 and 2.

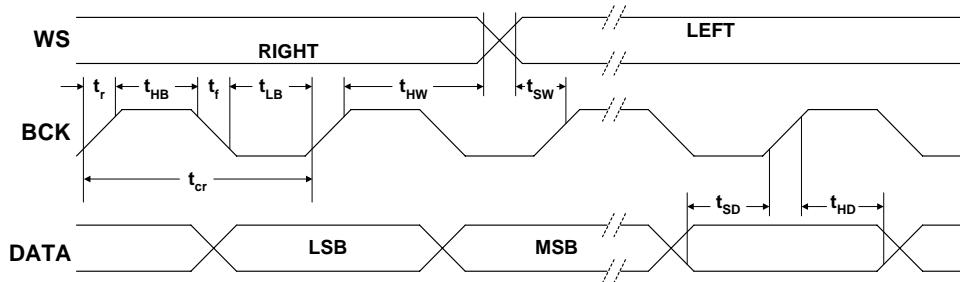

Fig.1 Timing and input signals.

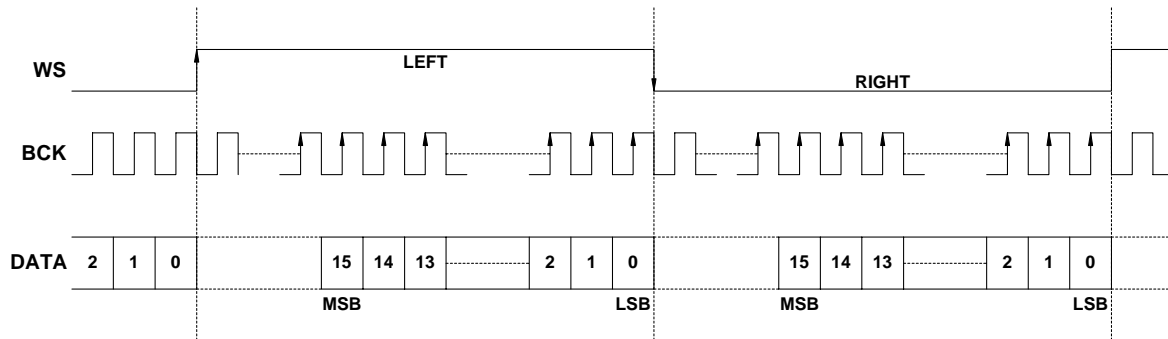

Fig.2 Format of input signals.

Data format (BCK, WS, DATA)

Symbol	Parameter	Conditions	Min	Typ	Max	Unit
V _{IL}	Input LOW level		-	-	0.3V _{DD}	V
V _{IH}	Input HIGH level		0.7V _{DD}	-	-	V
I _{IL}	Input Leakage Current LOW		-	-	10	μA
I _{IH}	Input Leakage Current HIGH		-	-	10	μA
f _{BCK}	Input Clock Frequency		-	-	18.4	MHz
BR	Bit Rate Data Input		-	-	18.4	Mbits/s
f _{WS}	Word Select Input		-	-	384	kHz
t _r	Rise Time		-	-	12	ns
t _f	Fall Time		-	-	12	ns
t _{Cr}	Bit Clock Cycle Time		54	-	-	ns
t _{HB}	Bit Clock High Time		15	-	-	ns
t _{LB}	Bit Clock Low Time		15	-	-	ns
t _{SD}	Data Set-up Time		12	-	-	ns
t _{HD}	Data Hold Time to Bit Clock		2	-	-	ns
t _{HW}	Word Select Hold Time		2	-	-	ns
t _{SW}	Word Select Set-up Time		12	-	-	ns

APPLICATION INFORMATION

Basic application example

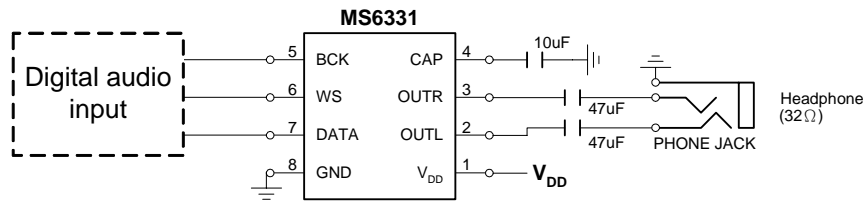

Note : $V_o=1.95V_{pp}$ at $V_{DD}=3.3V$

EXTERNAL DIMENSIONS

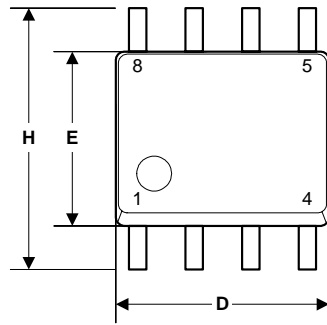

Symbol	Dimension in mm		Dimension in inch	
	Min	Max	Min	Max
A	1.35	1.75	0.0532	0.0688
A1	0.10	0.25	0.0040	0.0098
B	0.33	0.51	0.013	0.020
C	0.19	0.25	0.0075	0.0098
D	4.80	5.00	0.1890	0.1968
H	5.80	6.20	0.2284	0.2440
E	3.80	4.00	0.1497	0.1574
e	1.27 BSC		0.050 BSC	
L	0.40	1.27	0.016	0.050

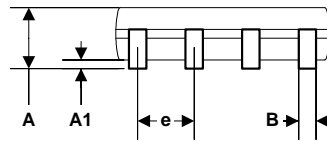

SOP8

TAPE AND REEL (Unit : mm)

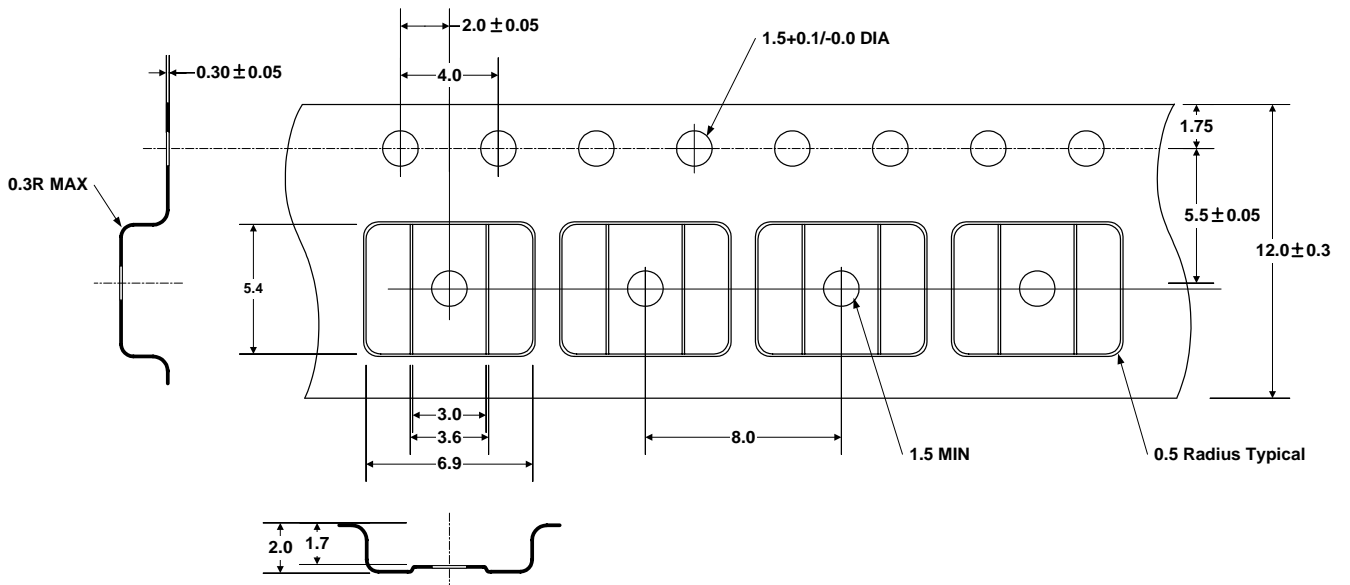

SOP8