

# Cascadable Silicon Bipolar MMIC Amplifier

## Technical Data

### MSA-2111

#### Features

- **Cascadable 50  $\Omega$  Gain Block**
- **Medium Power:**  
10 dBm at 900 MHz
- **High Gain:**  
16.5 dB Typical at 900 MHz
- **Low Noise Figure:**  
3.3 dB Typical at 900 MHz
- **Low Cost Surface Mount  
Plastic Package**
- **Tape-and-Reel Packaging  
Option Available<sup>(1)</sup>**

#### Note:

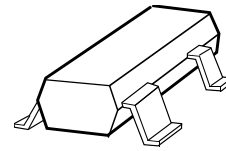
1. Refer to PACKAGING section "Tape-and-Reel Packaging for Semiconductor Devices."

#### Description

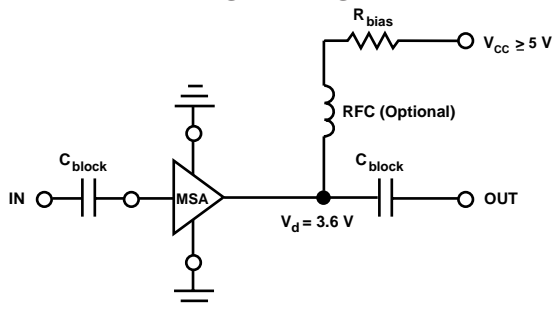
The MSA-2111 is a low cost silicon bipolar Monolithic Microwave Integrated Circuit (MMIC) housed in a surface mount plastic SOT-143 package. This MMIC is designed for use as a general purpose 50  $\Omega$  gain block. Typical applications include narrow and broad band IF and RF amplifiers in commercial and industrial applications.

The MSA-series is fabricated using HP's 10 GHz  $f_T$ , 25 GHz  $f_{MAX}$ , silicon bipolar MMIC process which uses nitride self-alignment, ion implantation, and gold metallization to achieve excellent performance, uniformity and reliability. The use of an external bias resistor for temperature and current stability also allows bias flexibility.

#### SOT-143 Package



#### Typical Biasing Configuration



## MSA-2111 Absolute Maximum Ratings

Parameter	Absolute Maximum <sup>[1]</sup>
Device Current	40 mA
Power Dissipation <sup>[2,3]</sup>	125 mW
RF Input Power	+13 dBm
Junction Temperature	150°C
Storage Temperature	-65°C to 150°C

### Thermal Resistance<sup>[2]:</sup>

$$\theta_{jc} = 505^{\circ}\text{C/W}$$

#### Notes:

1. Permanent damage may occur if any of these limits are exceeded.
2.  $T_{\text{CASE}} = 25^{\circ}\text{C}$ .
3. Derate at 2.0 mW/°C for  $T_{\text{C}} > 85^{\circ}\text{C}$ .

## Electrical Specifications<sup>[1]</sup>, $T_{\text{A}} = 25^{\circ}\text{C}$

Symbol	Parameters and Test Conditions: $I_{\text{d}} = 29 \text{ mA}$ , $Z_{\text{o}} = 50 \Omega$	Units	Min.	Typ.	Max.
GP	Power Gain ( $ S_{21} ^2$ ) $f = 900 \text{ MHz}$	dB	16.0	17.5	
$\Delta\text{GP}$	Gain Flatness $f = 0.1 \text{ to } 0.3 \text{ GHz}$	dB		$\pm 0.5$	
$f_3 \text{ dB}$	3 dB Bandwidth	GHz		0.5	
VSWR	Input VSWR $f = 0.1 \text{ to } 2.5 \text{ GHz}$			1.8:1	
	Output VSWR $f = 0.1 \text{ to } 2.5 \text{ GHz}$			1.8:1	
NF	50 $\Omega$ Noise Figure $f = 900 \text{ MHz}$	dB		3.3	
$P_{1 \text{ dB}}$	Output Power at 1 dB Gain Compression $f = 900 \text{ MHz}$	dBm		10	
$\text{IP}_3$	Third Order Intercept Point $f = 900 \text{ MHz}$	dBm		20	
$t_{\text{D}}$	Group Delay $f = 900 \text{ MHz}$	psec		158	
$V_{\text{d}}$	Device Voltage	V	2.9	3.6	4.3
$\text{dV/dT}$	Device Voltage Temperature Coefficient	mV/°C		-8.0	

#### Notes:

1. The recommended operating current range for this device is 12 to 35 mA. Typical gain performance as a function of current is on the following page.

## Part Number Ordering Information

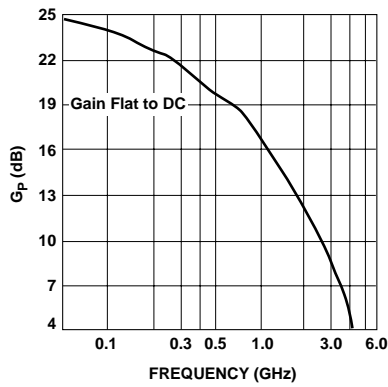
Part Number	No. of Devices	Container
MSA-2111-TR1	3000	7" Reel
MSA-2111-BLK	100	Antistatic Bag

For more information, see "Tape and Reel Packaging for Semiconductor Devices".

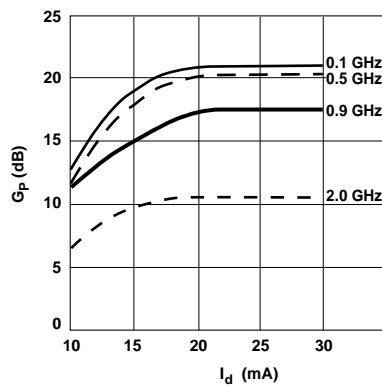
**MSA-2111 Typical Scattering Parameters ( $Z_0 = 50 \Omega$ ,  $T_A = 25^\circ\text{C}$ ,  $I_d = 29 \text{ mA}$ )**

Freq. GHz	S <sub>11</sub>		S <sub>21</sub>			S <sub>12</sub>			S <sub>22</sub>		k
	Mag	Ang	dB	Mag	Ang	dB	Mag	Ang	Mag	Ang	
0.1	.28	171	23.0	14.1	167	-26.0	.050	9	.27	177	1.03
0.2	.26	163	22.5	13.4	156	-25.5	.053	18	.27	175	1.03
0.3	.24	156	21.9	12.5	145	-24.9	.057	25	.26	173	1.03
0.4	.21	152	21.2	11.5	136	-24.0	.063	30	.26	171	1.03
0.5	.18	149	20.5	10.6	128	-23.4	.068	35	.24	170	1.03
0.6	.15	148	19.7	9.7	120	-22.6	.074	38	.24	169	1.03
0.7	.13	148	19.0	8.9	114	-21.8	.081	40	.22	169	1.04
0.8	.11	152	18.3	8.2	108	-21.1	.088	42	.21	169	1.04
0.9	.09	158	17.6	7.6	102	-20.4	.095	43	.20	168	1.04
1.0	.07	169	16.9	7.0	98	-19.9	.101	44	.19	169	1.05
1.5	.08	-123	14.0	5.0	79	-17.3	.136	45	.10	179	1.06
2.0	.11	-124	11.8	3.9	63	-15.5	.167	42	.06	-147	1.08
2.5	.15	-167	10.1	3.2	56	-14.3	.193	43	.06	-177	1.10
3.0	.27	158	8.3	2.6	43	-13.5	.211	38	.12	149	1.13
3.5	.38	145	6.8	2.2	32	-13.1	.222	34	.16	145	1.14
4.0	.46	135	5.6	1.9	21	-12.6	.234	30	.17	144	1.14

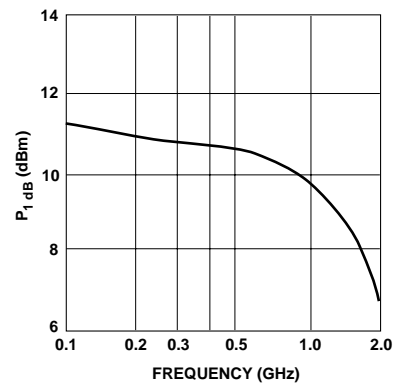
**Typical Performance,  $T_A = 25^\circ\text{C}$**   
(unless otherwise noted)



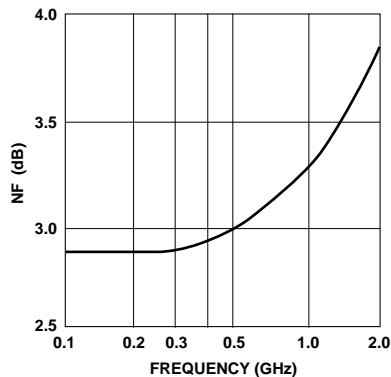
**Figure 1. Power Gain vs. Frequency,  $I_d = 29 \text{ mA}$ .**



**Figure 2. Power Gain vs. Current.**

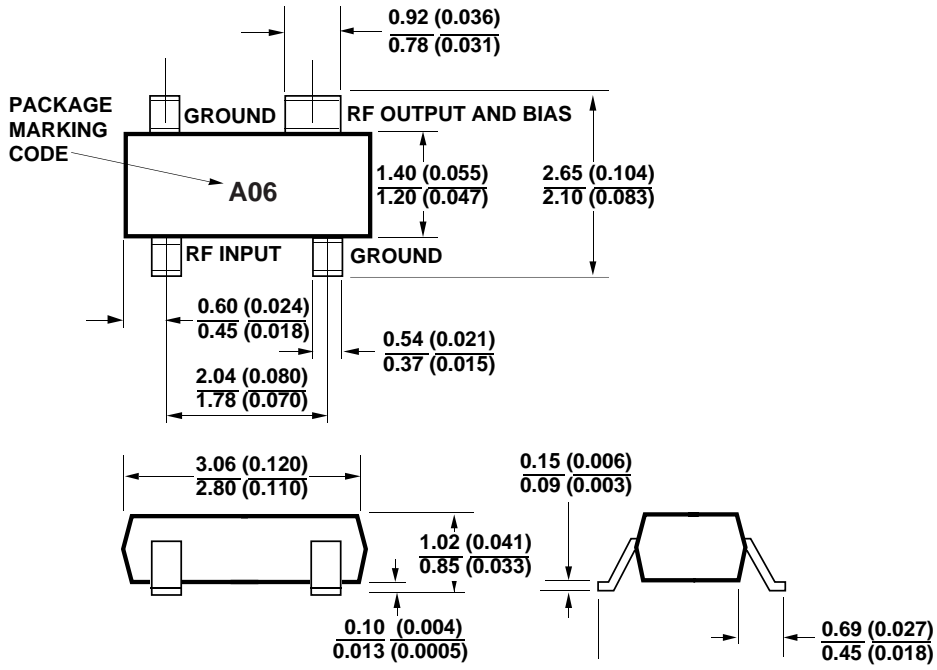


**Figure 3. Output Power at 1 dB Gain Compression vs. Frequency,  $I_d = 29 \text{ mA}$ .**



**Figure 4. Noise Figure vs. Frequency,  $I_d = 29 \text{ mA}$ .**

# SOT-143 Package Dimensions



DIMENSIONS ARE IN MILLIMETERS (INCHES)