

MSAU300 Series

1W, High Isolation SMD, Single & Dual Output DC/DC Converters

Key Features

- Efficiency up to 81%
- 3000VDC Isolation
- MTBF > 2,000,000 Hours
- Low Cost
- Input 5, 12 and 24VDC
- Output 5, 12, 15, ± 5 , ± 12 and ± 15 VDC
- Temperature Performance -40°C to $+85^{\circ}\text{C}$
- Lead Frame Technology
- UL 94V-0 Package Material
- Internal SMD Construction

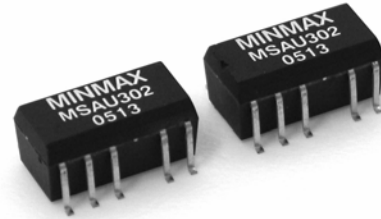

Minmax's MSAU300 1W DC/DC's are in "gull-wing" SMT package, weigh a mere 2.2 grams and meet $245^{\circ}\text{C}/10\text{sec}$ in solder-reflow for lead free process.

The series is designed to provide high levels of isolation 3000VDC. It consists of 18 models with input voltages of 5V, 12V and 24VDC which offers standard output voltages of 5V, 12V, 15V, ± 5 V, ± 12 V and ± 15 VDC for the choice. Their impressive guaranteed efficiencies enable all models to deliver their fully rated output power from -40°C to $+85^{\circ}\text{C}$ without heat sinking or forced-air cooling.

The MSAU300 series is an excellent selection for a variety of applications including data communication equipments, distributed power systems, telecommunication equipments and industrial robot systems.

The MSAU300 units are available in tape and reel package.

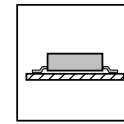

SMD

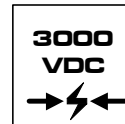

I/O Isolation

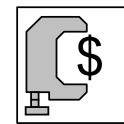

Low Cost

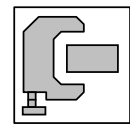

Low Profile

Block Diagram

Single Output

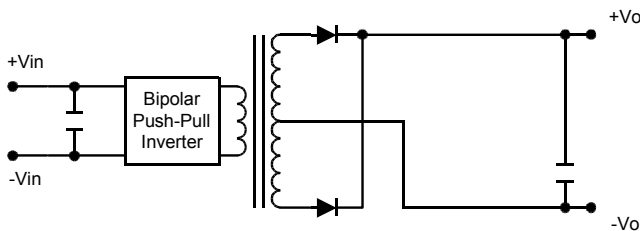

Dual Output

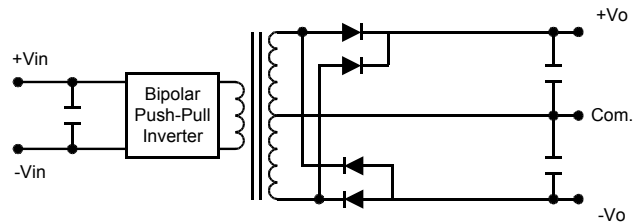

Model Selection Guide

Model Number	Input Voltage	Output Voltage	Output Current		Input Current		Load Regulation	Efficiency
			Max.	Min.	@Max. Load	@No Load		
	VDC	VDC	mA	mA	mA (Typ.)	mA (Typ.)	% (Max.)	% (Typ.)
MSAU301	5 (4.5 ~ 5.5)	5	200	4	281	30	10	71
MSAU303		12	84	1.5	258		7	78
MSAU304		15	67	1	258		7	78
MSAU306		±5	±100	±2	277		10	72
MSAU308		±12	±42	±0.8	255		7	78
MSAU309		±15	±34	±0.7	258		7	79
MSAU311	12 (10.8 ~ 13.2)	5	200	4	117	12	8	71
MSAU313		12	84	1.5	106		5	79
MSAU314		15	67	1	104		5	80
MSAU316		±5	±100	±2	112		8	74
MSAU318		±12	±42	±0.8	105		5	80
MSAU319		±15	±34	±0.7	104		5	81
MSAU321	24 (21.6 ~ 26.4)	5	200	4	58	7	8	71
MSAU323		12	84	1.5	53		5	78
MSAU324		15	67	1	53		5	79
MSAU326		±5	±100	±2	57		8	72
MSAU328		±12	±42	±0.8	53		5	79
MSAU329		±15	±34	±0.7	53		5	80

Absolute Maximum Ratings

Parameter	Min.	Max.	Unit	
Input Surge Voltage (1000 mS)	5VDC Input Models	-0.7	9	VDC
	12VDC Input Models	-0.7	18	VDC
	24VDC Input Models	-0.7	30	VDC
Lead Temperature (1.5mm from case for 10 Sec.)	---	300	°C	
Internal Power Dissipation	---	550	mW	

Exceeding the absolute maximum ratings of the unit could cause damage. These are not continuous operating ratings.

Environmental Specifications

Parameter	Conditions	Min.	Max.	Unit
Operating Temperature	Ambient	-40	+85	°C
Operating Temperature	Case	-40	+90	°C
Storage Temperature		-40	+125	°C
Humidity		---	95	%
Cooling	Free-Air Convection			

Input Specifications

Parameter	Model	Min.	Typ.	Max.	Unit
Input Voltage Range	5V Input Models	4.5	5	5.5	VDC
	12V Input Models	10.8	12	13.2	
	24V Input Models	21.6	24	26.4	
Reverse Polarity Input Current	All Models	---	---	0.3	A
Input Filter		Internal Capacitor			

Notes :

- Specifications typical at $T_a = +25^\circ\text{C}$, resistive load, nominal input voltage, rated output current unless otherwise noted.
- Ripple & Noise measurement bandwidth is 0-20 MHz.
- These power converters require a minimum output loading to maintain specified regulation.
- Operation under no-load conditions will not damage these modules; however, they may not meet all specifications listed.
- All DC/DC converters should be externally fused on the front end for protection.
- Other input and output voltage may be available, please contact factory.
- Specifications subject to change without notice.

MSAU300 Series

Output Specifications

Parameter	Conditions	Min.	Typ.	Max.	Unit
Output Voltage Accuracy		---	± 1.5	± 4.0	%
Output Voltage Balance	Dual Output, Balanced Loads	---	± 0.1	± 1.0	%
Line Regulation	For V_{in} Change of 1%	---	± 1.2	± 1.5	%
Load Regulation	$I_o=20\%$ to 100%	See Model Selection Guide			%
Ripple & Noise (20MHz)		---	50	75	mV P-P
Ripple & Noise (20MHz)	Over Line, Load & Temp.	---	---	150	mV P-P
Ripple & Noise (20MHz)		---	---	5	mV rms
Over Load		120	---	---	%
Temperature Coefficient		---	± 0.01	± 0.02	%/°C
Output Short Circuit	0.5 Second Max.				

General Specifications

Parameter	Conditions	Min.	Typ.	Max.	Unit
Isolation Voltage Rated	60 Seconds	3000	---	---	VDC
Isolation Voltage Test	Flash Tested for 1 Second	3300	---	---	VDC
Isolation Resistance	500VDC	10	---	---	GΩ
Isolation Capacitance	100KHz, 1V	---	60	100	pF
Switching Frequency		70	100	120	KHz
MTBF	MIL-HDBK-217F @ 25°C, Ground Benign	2000	---	---	K Hours

Capacitive Load

Models by Vout	5V	12V	15V	±5V #	±12V #	±15V #	Unit
Maximum Capacitive Load	33	4.7	4.7	10	2.2	2.2	uF

For each output

Input Fuse Selection Guide

5V Input Models	12V Input Models	24V Input Models
500mA Slow – Blow Type	200mA Slow – Blow Type	100mA Slow – Blow Type

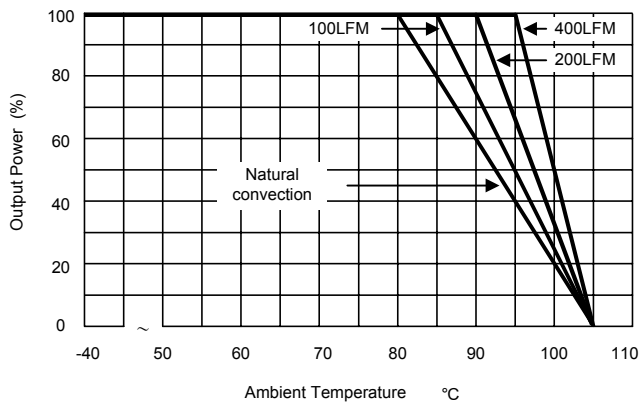

Derating Curve

Test Configurations

Input Reflected-Ripple Current Test Setup

Input reflected-ripple current is measured with an inductor L_{in} (4.7 μ H) and C_{in} (220 μ F, ESR < 1.0 Ω at 100 KHz) to simulate source impedance.

Capacitor C_{in} , offsets possible battery impedance. Current ripple is measured at the input terminals of the module, measurement bandwidth is 0–500 KHz.

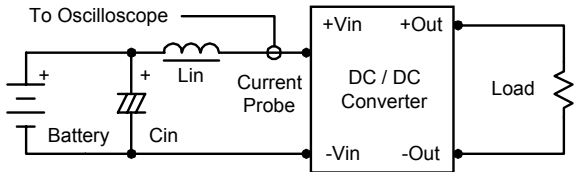

Peak-to-Peak Output Noise Measurement Test

Use a C_{out} 0.33 μ F ceramic capacitor.

Scope measurement should be made by using a BNC socket, measurement bandwidth is 0–20 MHz. Position the load between 50 mm and 75 mm from the DC/DC Converter.

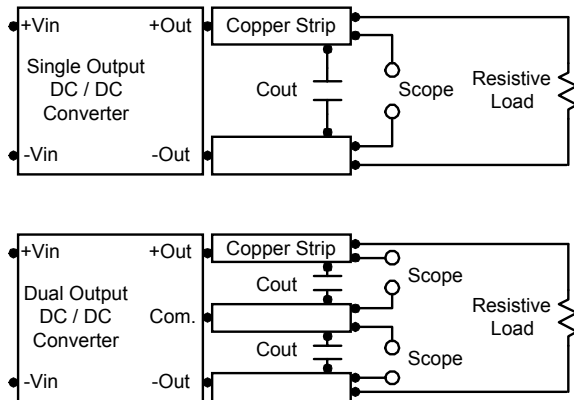

Design & Feature Considerations

Maximum Capacitive Load

The MSAU300 series has limitation of maximum connected capacitance at the output.

The power module may be operated in current limiting mode during start-up, affecting the ramp-up and the startup time.

The maximum capacitance can be found in the data sheet.

Input Source Impedance

The power module should be connected to a low ac-impedance input source. Highly inductive source impedances can affect the stability of the power module.

In applications where power is supplied over long lines and output loading is high, it may be necessary to use a capacitor at the input to ensure startup.

Capacitor mounted close to the power module helps ensure stability of the unit, it is recommended to use a good quality low Equivalent Series Resistance (ESR < 1.0 Ω at 100 KHz) capacitor of a 2.2 μ F for the 5V input devices, a 1.0 μ F for the 12V input devices and a 0.47 μ F for the 24V devices.

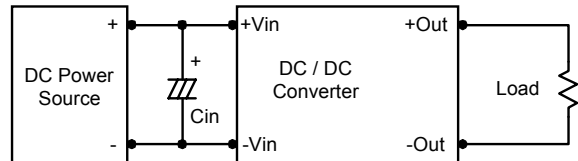

Output Ripple Reduction

A good quality low ESR capacitor placed as close as practicable across the load will give the best ripple and noise performance.

To reduce output ripple, it is recommended to use 1.0 μ F capacitors at the output.

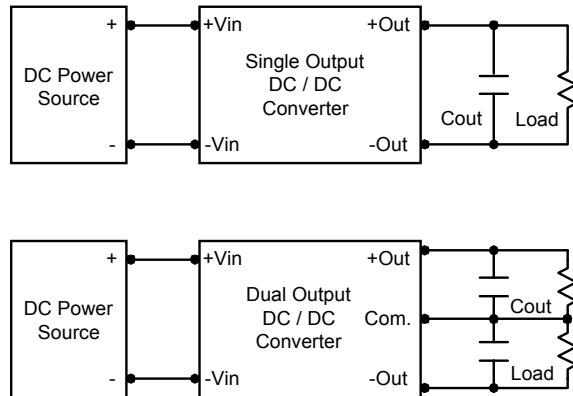

Thermal Considerations

Many conditions affect the thermal performance of the power module, such as orientation, airflow over the module and board spacing. To avoid exceeding the maximum temperature rating of the components inside the power module, the case temperature must be kept below 90°C.

The derating curves are determined from measurements obtained in an experimental apparatus.

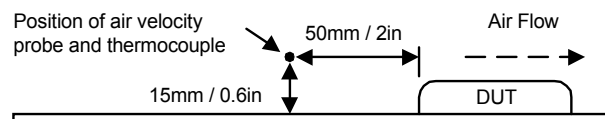

Mechanical Dimensions

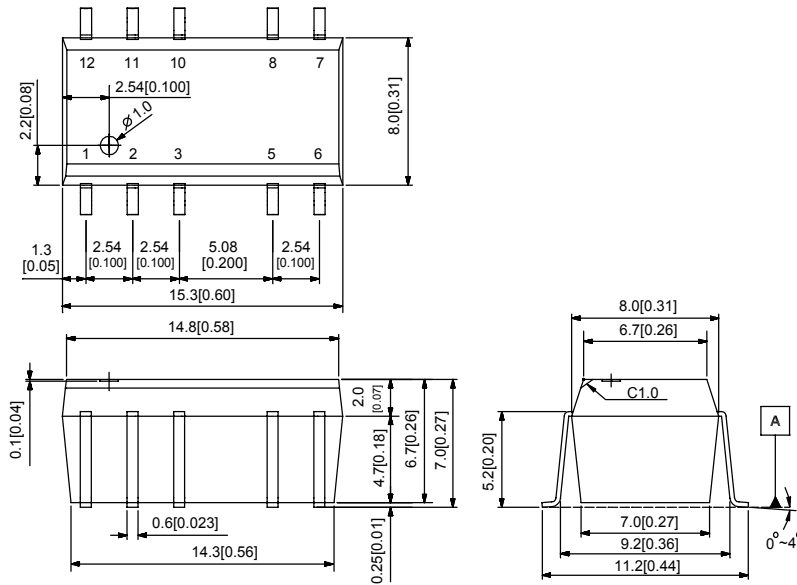

Connecting Pin Patterns

Top View (2.54 mm / 0.1 inch grids)

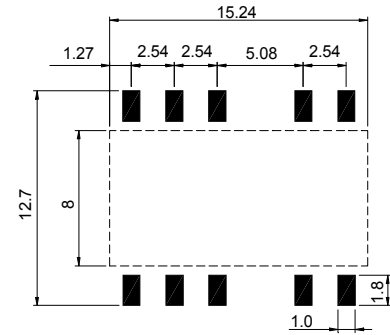

Tolerance	Millimeters	Inches
	X.X±0.25	X.XX±0.01
	X.XX±0.13	X.XXX±0.005
Pin	±0.05	±0.002

Pin Connections

Pin	Single Output	Dual Output
1	-Vin	-Vin
2	+Vin	+Vin
3	NA	NA
5	-Vout	Common
6	NA	-Vout
7	NA	NA
8	+Vout	+Vout
10	NA	NA
11	NA	NA
12	NA	NA

NA: Not Available for Electrical Connection

Physical Characteristics

Case Size : 15.3×8.0×7.0 mm
0.60×0.31×0.27 inches

Case Material : Molding

Weight : 2.2g

Flammability : UL94V-0

The MSAU300 converter is encapsulated in a low thermal resistance molding compound that has excellent resistance/electrical characteristics over a wide temperature range or in high humidity environments. The encapsulant and unit case are both rated to UL 94V-0 flammability specifications. Leads are tin plated for improved solderability.