

MSK

M. S. KENNEDY CORP.

**DUAL ULTRA
HIGH SPEED AMPLIFIER****450**

4707 Dey Road Liverpool, N.Y. 13088

(315) 701-6751

MIL-PRF-38534 QUALIFIED**FEATURES:**

- Very High Output Slew Rate - Up to $2000V/\mu S$
- Low Quiescent Current - $\pm 6.5mA$ (per Amplifier)
- Fast Settling Time - 100nS to 0.1% @ $V_{IN} = 10V$
- Wide Bandwidth - 65MHz at Gain of -1
- 20MHz Full Power Bandwidth - 20VPP @ $R_L = 500\Omega$
- Ultra Low Offset - $\pm 50\mu V$
- Very Low Offset Drift - $\pm 1.0\mu V/^\circ C$
- Space Efficient Dual
- Available in Surface Mount Package

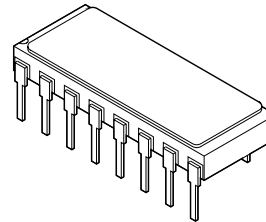
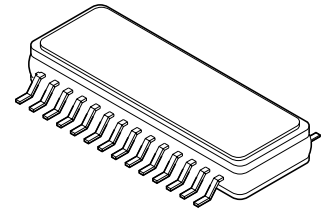
**MSK 450 Q****MSK 450 R****DESCRIPTION:**

The MSK 450 is a dual high speed operational amplifier that exhibits an impressive combination of high bandwidth, speed and precision D.C. characteristics. The hybrid's current feedback architecture provides much better ac performance, higher linearity and cleaner pulse response than traditional Op-Amps which make the MSK 450 an excellent choice as a Flash A/D converter driver or one of a variety of video type applications. The MSK 450 delivers hybrid performance at a monolithic price. The MSK 450 is available in a 16 pin ceramic dip as well as a 28 pin surface mount package.

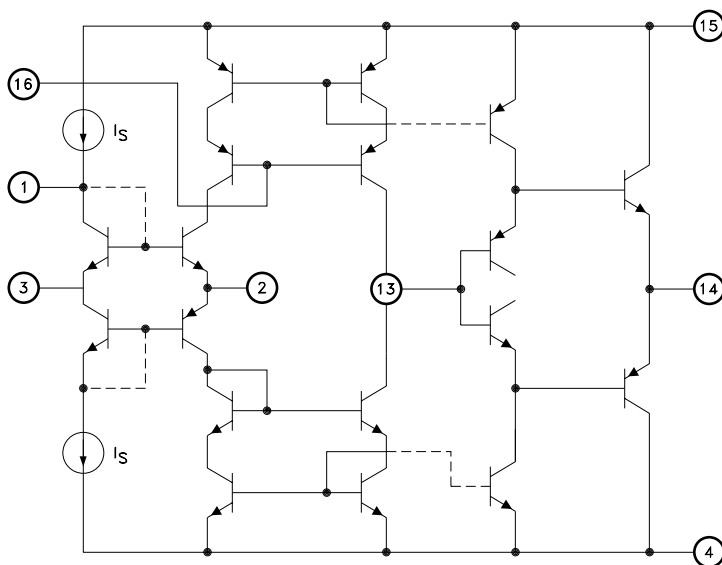
EQUIVALENT SCHEMATIC

The MSK 450 contains two totally isolated independent monolithic integrated circuits. The equivalent schematic of one half of the MSK 450 Q is shown to the left.

PIN-OUT INFORMATION**"Q" Package**

1 Balance A	16 Balance A
2 -Input A	15 +Vcc A
3 +Input A	14 Output A
4 -Vcc A	13 FF A
5 Balance B	12 Balance B
6 -Input B	11 +Vcc B
7 +Input B	10 Output B
8 -Vcc B	9 FF B

"R" Package

1 Balance A	28 Balance A
2 NC	27 NC
3 -Input A	26 +Vcc A
4 NC	25 NC
5 +Input A	24 Output A
6 -Vcc A	23 FF A
7 NC	22 NC
8 NC	21 NC
9 Balance B	20 Balance B
10 NC	19 NC
11 -Input B	18 +Vcc B
12 NC	17 NC
13 +Input B	16 Output B
14 -Vcc B	15 FF B

TYPICAL APPLICATIONS

- Flash ADC Amplifiers
- High Speed Current DAC Interfaces
- Video Distribution
- Pulse Amplifiers
- High Speed Communication
- Radar, IF Processors

ABSOLUTE MAXIMUM RATINGS

$\pm V_{CC}$	Supply Voltage	$\pm 18V$
V_{IC}	Common Mode Input Voltage	$\pm V_{CC}$
V_{IND}	Differential Input Voltage	6V
I_{IN}	Inverting Input Current (Continuous)	5mA
I_{OS}	Output Short Circuit Duration	Indefinite
T_C	Case Operating Temperature Range (MSK 450B/E)	-55°C to +125°C
	(MSK 450)	-40°C to +85°C

R_{TH}	Thermal Resistance	10°C/W
	Junction to Case	
T_{ST}	Storage Temperature Range	-65°C to +150°C
T_{LD}	Lead Temperature	300°C
	(10 Seconds)	
P_D	Power Dissipation	1.5W
T_J	Junction Temperature	175°C

ELECTRICAL SPECIFICATIONS

$\pm V_{CC} = 15VDC$ Unless Otherwise Specified

Parameter	Test Conditions	Group A Subgroup	MSK 450B/E			MSK 450			Units
			Min.	Typ.	Max.	Min.	Typ.	Max.	
STATIC									
Supply Voltage Range ② ⑦		-	± 4.5	± 15	± 18	± 4.5	± 15	± 18	V
Quiescent Current	$V_{IN} = 0V$	1	-	± 6.5	± 8	-	± 6.5	± 10	mA
	Each Amplifier	2,3	-	± 8.5	± 10	-	-	-	mA
INPUT									
Input Offset Voltage	$V_{IN} = 0V$	1	-	± 50	± 325	-	± 50	± 500	μV
Input Offset Drift	$V_{IN} = 0V$	2,3	-	± 1.0	± 7.5	-	± 1.0	-	$\mu V/^\circ C$
Input Offset Voltage ②	vs. V_{CC}	-		4	20		4	20	$\mu V/V$
Input Bias Current	$V_{CM} = 0V$	1	-	± 250	± 500	-	± 250	± 550	nA
	Either Input	2,3	-	± 1800	± 2800	-	-	-	nA
Input Resistance ②	-Input	-	-	50	65	-	50	65	Ω
	+Input	-	7	10	-	7	10	-	M Ω
Input Capacitance ②	Either Input	-	-	2	-	-	2	-	pF
Input Voltage Range ②	Common Mode	-	± 10	-	-	± 10	-	-	V
Input Voltage Noise ②	$F \geq 1KHz$	-	-	2.0	2.5	-	2.0	2.5	$nV\sqrt{Hz}$
Input Current Noise ②	$F = 1KHz$	-	-	12.0	15.0	-	12.0	15.0	$pA\sqrt{Hz}$
OUTPUT									
Output Voltage Swing	$R_L = 500\Omega$ $F \leq 10MHz$	4	± 10	± 11	-	± 10	± 11	-	V
Output Current	Continuous	4	± 50	± 80	-	± 50	± 80	-	mA
Settling Time ① ②	0.1% 10V step	4	-	100	125	-	100	125	nS
	1.0% 10V step	4	-	50	65	-	50	65	nS
Full Power Bandwidth	$V_O = \pm 10V$	4	15	20	-	15	20	-	MHz
Bandwidth (Small Signal) ②	Input = 0dBm	4	50	65	-	45	65	-	MHz
Harmonic Distortion ②	$V_{IN} = 2V_{RMS}$	-	-	0.005	-	-	0.005	-	%
Output Resistance ②	Open Loop	-	-	12	-	-	12	-	Ω
TRANSFER CHARACTERISTICS									
Slew Rate	$V_{OUT} = \pm 10V$	4	1200	2000	-	1200	2000	-	$V/\mu S$
Open Loop Transresistance	$V_{OUT} = \pm 10V$	4	2.3	3.0	-	2.0	3.0	-	M Ω
Transcapacitance ②		-	-	4.5	-	-	4.5	-	pF
Differential Phase Error ②	$F = 4.4MHz$	-	-	± 0.1	-	-	± 0.1	-	Degree
Differential Gain Error ②	$F = 4.4MHz$	-	-	0.03	-	-	0.03	-	%

NOTES:

- ① $AV = -1$, measured in false summing junction circuit.
- ② Guaranteed by design but not tested. Typical parameters are representative of actual device performance but are for reference only.
- ③ Industrial grade and "E" suffix devices shall be tested to subgroups 1 and 4 unless otherwise specified.
- ④ Military grade devices ("B" suffix) shall be 100% tested to subgroups 1,2,3 and 4.
- ⑤ Subgroups 5 and 6 testing available upon request.
- ⑥ Subgroup 1,4 $T_A = T_C = +25^\circ C$
 Subgroup 2,5 $T_A = T_C = +125^\circ C$
 Subgroup 3,6 $T_A = T_C = -55^\circ C$
- ⑦ Electrical specifications are derated for power supply voltages other than $\pm 15VDC$.

APPLICATION NOTES

STABILITY AND LAYOUT CONSIDERATIONS

As with all wideband devices, proper decoupling of the power lines is extremely important. The power supplies should be bypassed, as near to the power supply pins as possible, with a parallel grouping of a $0.1\mu\text{F}$ ceramic disc and a $4.7\mu\text{F}$ tantalum capacitor. Ferrite beads can also be very helpful in some demanding applications. A small resistor should be used in series with the supply pins (4.7Ω TYP.). Wideband devices are also sensitive to printed circuit board layout. Be sure to keep all runs as short as possible, especially those associated with the summing junction and power lines. Circuit traces should be surrounded by ground planes whenever possible to reduce unwanted resistance and inductance. The curve below shows the relationship between resonant frequency and capacitor value for 3 trace lengths.

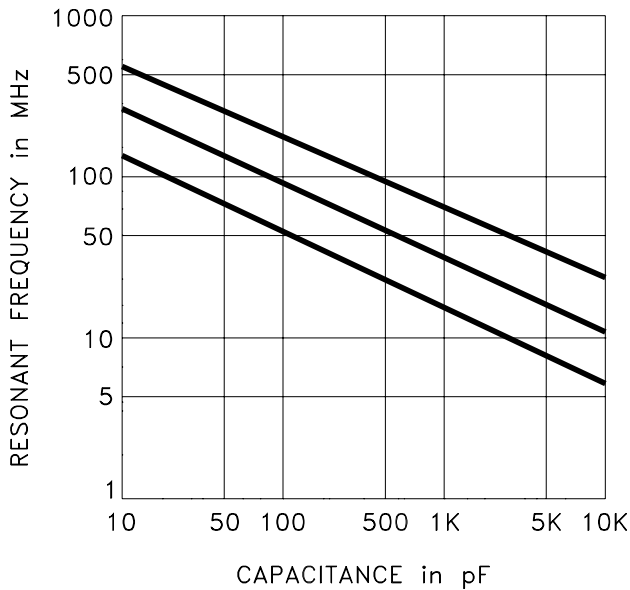

EXTERNAL COMPONENT SELECTION

The table below illustrates nominal values for the feedback and input resistors for various closed loop gain settings. These values were chosen to yield high bandwidth with minimal peaking.

External Component Selection Guide

Gain (V/V)	R1	R2
-1	1K Ω	1K Ω
-5	200 Ω	1K Ω
-10	50 Ω	500 Ω
+10	50 Ω	450 Ω

OPTIONAL OFFSET NULL

Typically, the MSK 450 has an input offset voltage of only $50\mu\text{V}$. When the feedback resistor value is $\geq 1\text{K}\Omega$, it may be desirable to null the offset externally, because of the bias current at the inverting input. Figure 1 below illustrates optional offset null for one side of the MSK 450 Q.

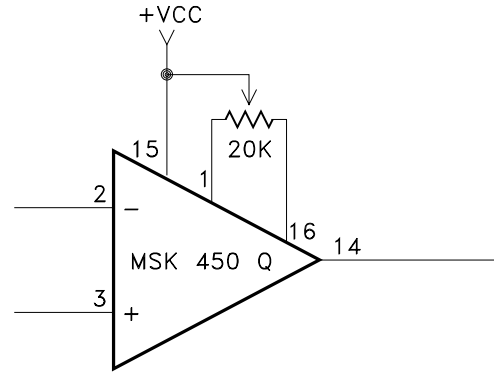

Figure 1

LARGE CAPACITIVE LOADS

When it is required to drive capacitive loads greater than 100pF, an external network can be connected as shown in Figure 2. For $C_L = 1000\text{pF}$, R3 should be 750 Ω and C1 should be 22pF. This network should be connected between the output and feed forward pins of the hybrid. This circuit will yield a maximum slew rate of approximately $100\text{V}/\mu\text{S}$. For bandwidth and stability, the optimum value of R3 should be empirically determined.

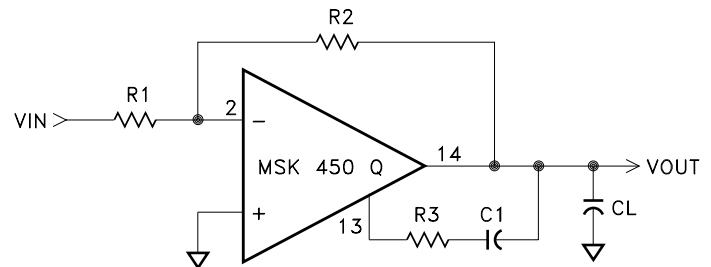
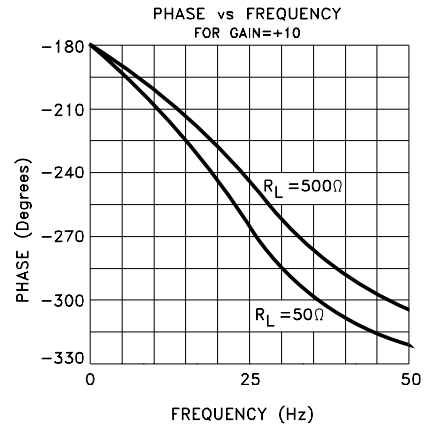
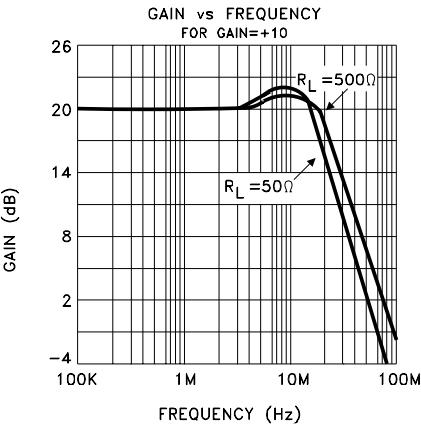
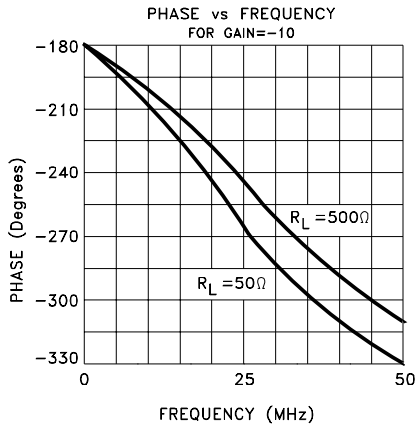
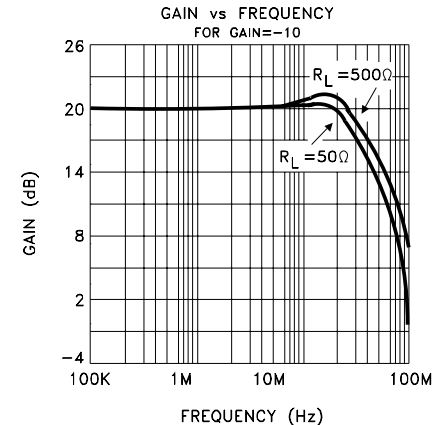
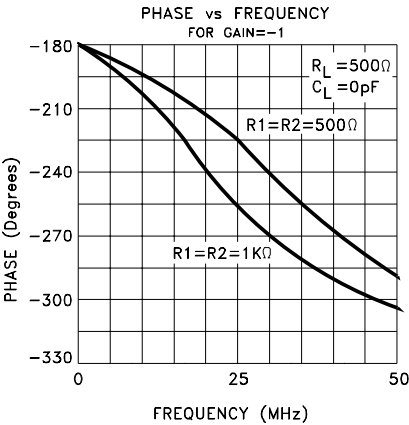
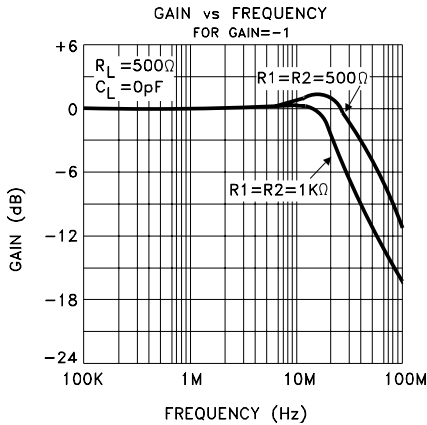
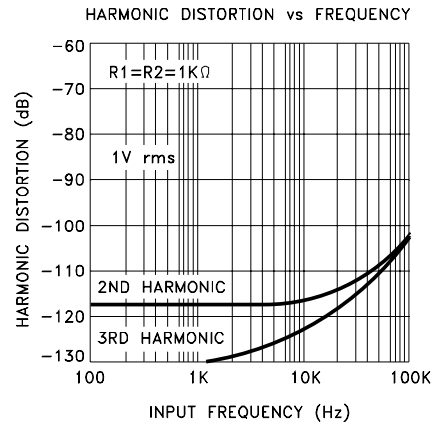
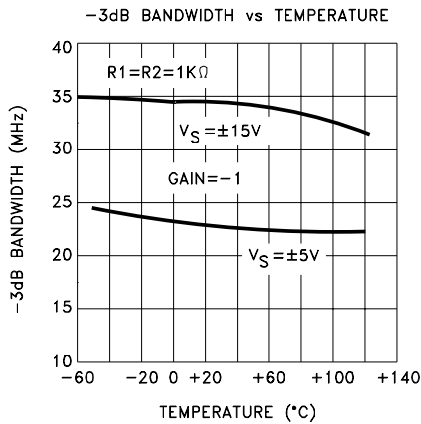
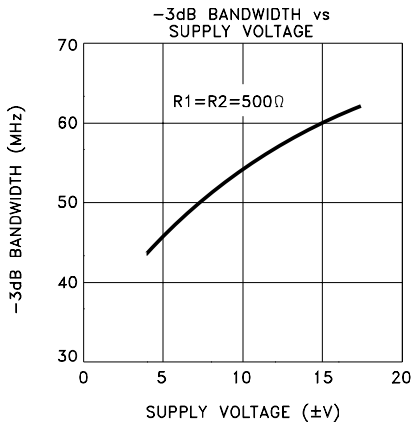
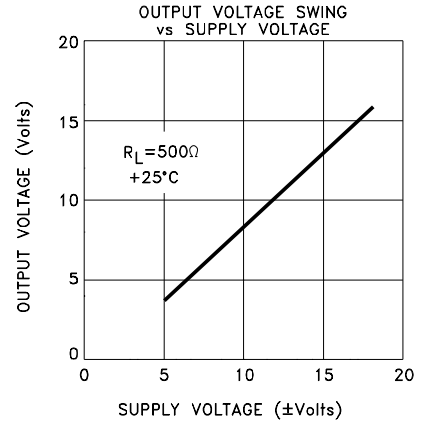
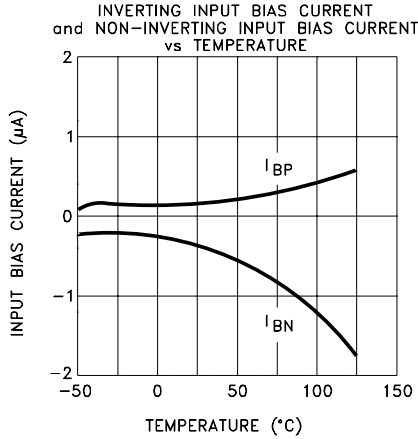
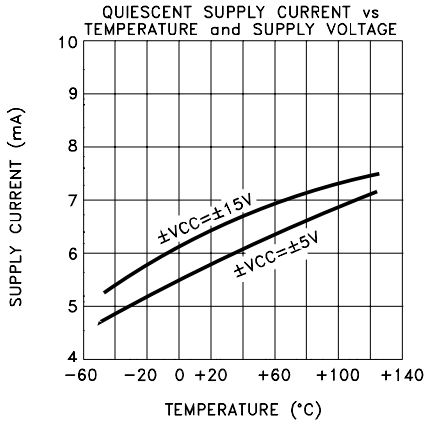

Figure 2

NON-INVERTING APPLICATIONS

The MSK 450 is suited for use at gains of 10 or greater when being used in the non-inverting mode. The reason for this is that the non-inverting input cannot tolerate transients greater than $\pm 1\text{V}$. However, the MSK 450 can be used at lower non-inverting gains if the input voltage remains small. Please consult factory for further information.

TYPICAL PERFORMANCE CURVES



MECHANICAL SPECIFICATIONS

MSK 450 Q

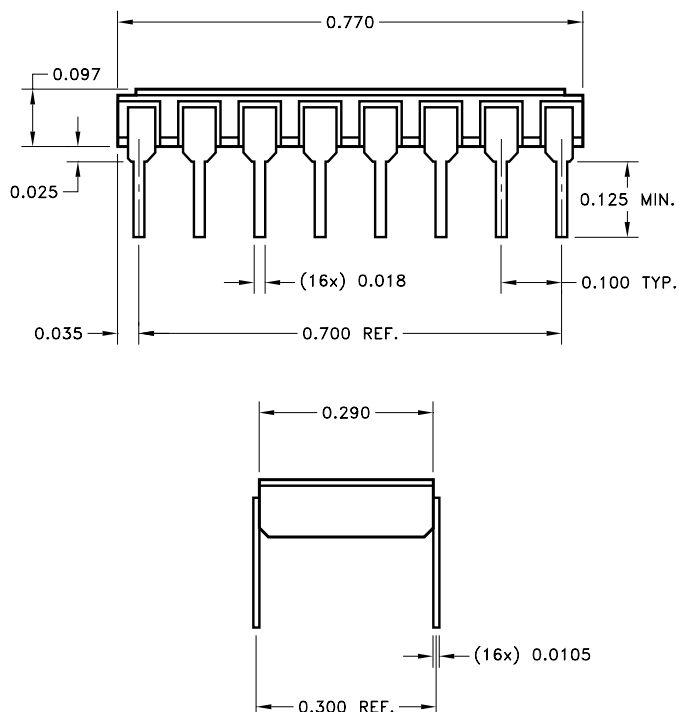

MSK 450 R

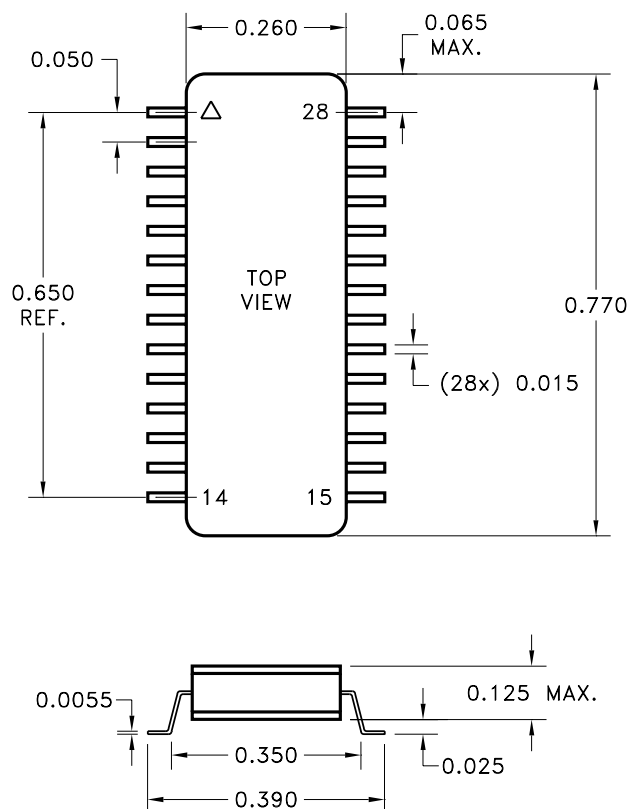

ESD TRIANGLE INDICATES PIN 1.

NOTE: ALL DIMENSIONS ARE ± 0.010 INCHES UNLESS OTHERWISE LABELED.

ORDERING INFORMATION

Part Number	Screening Level
MSK 450Q	Industrial
MSK 450EQ	Extended Reliability
MSK 450BQ	Mil-PRF-38534 Class H
MSK 450R	Industrial
MSK 450ER	Extended Reliability
MSK 450BR	Mil-PRF-38534 Class H

M.S. Kennedy Corp.
 4707 Dey Road, Liverpool, New York 13088
 Phone (315) 701-6751
 FAX (315) 701-6752
www.mskennedy.com

The information contained herein is believed to be accurate at the time of printing. MSK reserves the right to make changes to its products or specifications without notice, however, and assumes no liability for the use of its products. Please visit our website for the most recent revision of this datasheet.