



M.S.KENNEDY CORP.

600V/200A THREE PHASE BRIDGE PEM WITH BRAKE

4851

4707 Dey Road Liverpool, N.Y. 13088

(315) 701-6751

FEATURES:

- Full Three Phase Bridge Configuration with SCR/IGBT Brake
- 600V Rated Voltage
- 200A Continuous Output Current
- Internal Zener Clamps on Gates
- Proprietary Encapsulation Provides Near Hermetic Performance
- MIL-PRF-38534 Screening Available (Modified)
- Light Weight Domed ALSIC Baseplate
- Robust Mechanical Design for Hi-Rel Applications
- Ultra-Low Inductance Internal Layout
- Withstands 96 Hours HAST and Thermal Cycling (-55 °C to + 125 °C)

MIL-PRF-38534 CERTIFIED

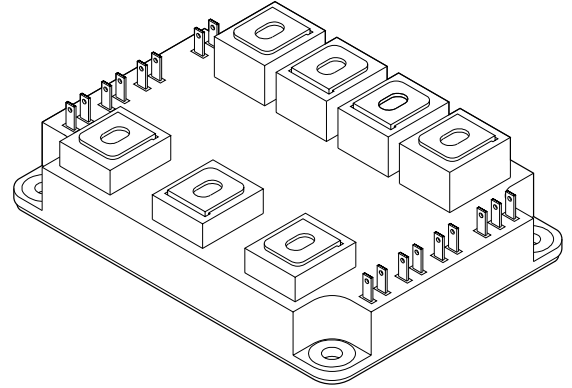

DESCRIPTION:

The MSK 4851 is one of a family of plastic encapsulated modules (PEM) developed specifically for use in military, aerospace and other severe environment applications. The Three Phase Bridge configuration along with the SCR/IGBT brake circuit and 600 volt/200 amp rating make it ideal for use in high current motor drive and inverter applications. The Aluminum Silicon Carbide (AlSiC) baseplate offers superior flatness and light weight; far better than the copper or copper alloys found in most high power plastic modules. The high thermal conductivity materials used to construct the MSK 4851 allow high power outputs at elevated baseplate temperatures. Our proprietary coating, SEES™ - Severe Environment Encapsulation System - protects the internal circuitry of MSK PEM's from moisture and contamination, allowing them to pass the rugged environmental screening requirements of military and aerospace applications. MSK PEM's are also available with industry standard silicone gel coatings for a lower cost option.

EQUIVALENT SCHEMATIC

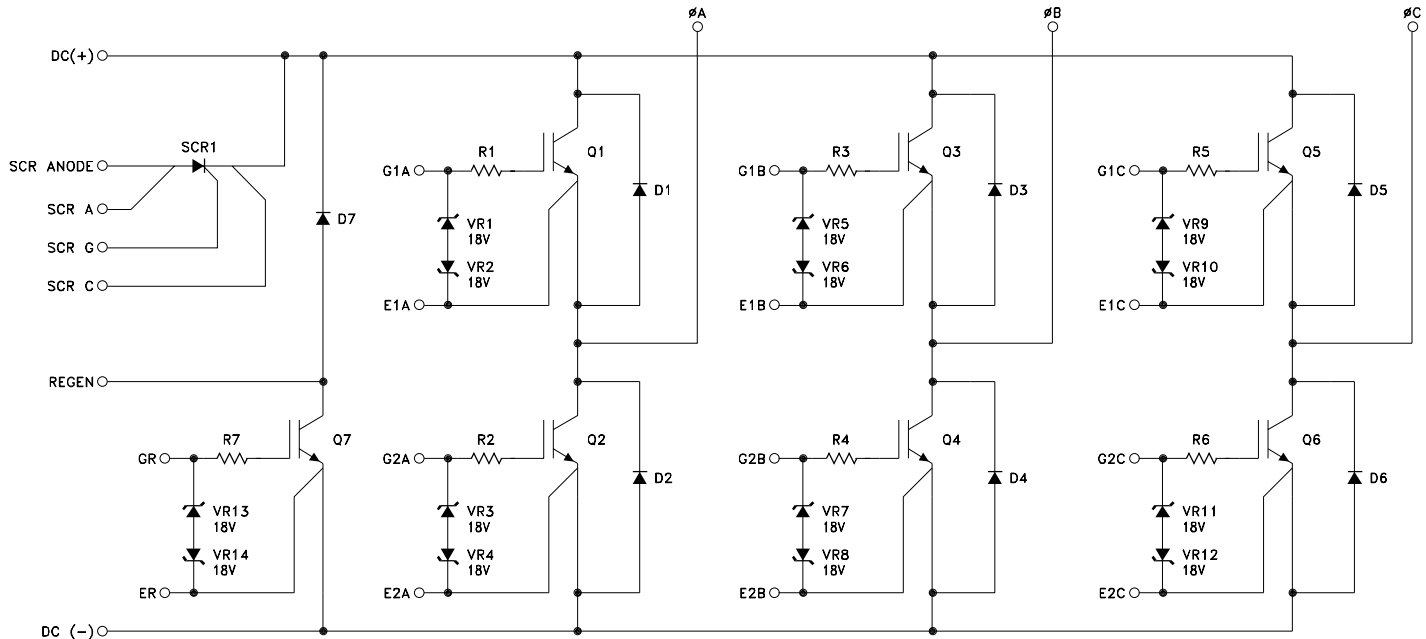

TYPICAL APPLICATIONS

- Motor Drives
- Inverters

ABSOLUTE MAXIMUM RATING ^⑧

V _{CE}	Collector to Emitter Voltage	600V
V _{GE}	Gate to Emitter Voltage	± 20V
I _{OUT}	Current (Continuous)	200A
I _{OUTP}	Current Pulsed (1mS)	400A
V _{CASE}	Case Isolation Voltage	2500V

T _{ST}	Storage Temperature Range	-55°C to +125°C
T _J	Junction Temperature	150°C
T _C	Case Operating Temperature Range	
	MSK 4851H/E	-55°C to +125°C
	MSK 4851	-40°C to +85°C

ELECTRICAL SPECIFICATIONS

Parameter ^⑥	Test Conditions	Group A Subgroup	MSK 4851 H/E			MSK 4851			Units
			Min.	Typ.	Max.	Min.	Typ.	Max.	
Collector-Emitter Saturation Voltage	I _C = 200A, V _{GE} = 15V	1	-	1.9	2.6	-	1.9	2.7	V
		2	-	1.9	2.6	-	1.9	2.7	V
		3	-	2.0	2.8	-	2.0	2.9	V
Collector-Emitter Leakage Current	V _{CE} = 600V, V _{GE} = 0V	1	-	0.01	1.0	-	0.01	1.5	mA
		2	-	0.01	9.0	-	0.01	10.0	mA
		① 3	-	0.01	1.5	-	0.01	2.0	mA
Gate Threshold Voltage	I _C = 30mA, V _{CE} = V _{GE}	1	4.0	5.8	7.5	4.0	5.8	7.5	V
		2	4.0	5.8	7.5	4.0	5.8	7.5	V
		3	4.0	6.2	7.5	4.0	6.2	7.5	V
Gate Leakage Current	V _{CE} = 0V, V _{GE} = ± 15V	1	-10	0.10	10	-12	0.10	12	uA
		2	-10	0.15	10	-12	0.15	12	uA
		3	-10	0.10	10	-12	0.10	12	uA
Diode Forward Voltage	I _C = 200A	1	-	1.5	2.6	-	1.5	2.7	V
		2	-	1.5	2.7	-	1.5	2.8	V
		3	-	1.6	2.8	-	1.6	2.9	V
SCR Reverse Leakage	V _{RRM} = 600V	1	-	0.01	15	-	0.01	18	mA
		2	-	0.01	15	-	0.01	18	mA
		3	-	0.01	15	-	0.01	18	mA
SCR On Voltage	I _F = 100A	1	-	1.0	1.35	-	1.0	1.4	V
		2	-	1.0	1.35	-	1.0	1.4	V
		3	-	1.0	1.5	-	1.0	1.6	V
SCR Holding Current		1	-	100	300	-	100	325	mA
		2	-	90	300	-	90	325	mA
		3	-	110	300	-	110	325	mA
Regen Diode Forward Voltage	I _F = 50A	1	-	1.3	2.4	-	1.3	2.5	V
Total Gate Charge ^①	V = 300V, I _C = 200A	4	-	1000	1700	-	1000	1700	nC
Turn-On Delay ^①	V = 300V, I _C = 200A, R _G = 20Ω	4	-	450	900	-	450	900	nS
Rise Time ^①	V = 300V, I _C = 200A, R _G = 20Ω	4	-	200	700	-	200	700	nS
Turn-Off Delay ^①	V = 300V, I _C = 200A, R _G = 10Ω	4	-	0.78	2.1	-	0.78	2.1	uS
Fall Time ^①	V = 300V, I _C = 200A, R _G = 10Ω	4	-	52	300	-	52	300	nS
Diode Reverse Recovery Time ^①	I _E = 200A, di/dt = 400A/uS	4	-	65	170	-	65	170	nS
Diode Reverse Recovery Charge ^①	I _E = 200A, di/dt = 400A/uS	4	-	1.5	2.5	-	1.5	2.5	uC
Thermal Resistance ^①	IGBT @ T _J = 125°C	4	-	0.18	0.20	-	0.18	0.25	°C/W
	BRIDGE DIODE @ T _J = 125°C	4	-	0.3	0.36	-	0.3	0.40	°C/W
	REGEN SCR	4	-	0.25	0.27	-	0.25	0.28	°C/W
	REGEN DIODE	4	-	0.7	0.8	-	0.7	0.9	°C/W

NOTES:

- ① Guaranteed by design but not tested. Typical parameters are representative of actual device performance but are for reference only.
- ② Industrial grade and "E" suffix devices shall be tested to subgroup 1 unless otherwise specified.
- ③ Military grade devices ("H" suffix) shall be 100% tested to subgroups 1, 2 and samples tested to subgroup 3.
- ④ Subgroups 4, 5 and 6 testing available upon request.
- ⑤ Subgroup 1, 4 T_A = +25°C
2, 5 T_A = +125°C
3, 6 T_A = -55°C
- ⑥ All specifications apply to both the upper and lower sections of the half bridge.
- ⑦ V_{GE} = 15V unless otherwise specified.
- ⑧ Continuous operation at or above absolute maximum ratings may adversely effect the device performance and/or life cycle.

TYPICAL PERFORMANCE CURVES

TYPICAL OUTPUT CHARACTERISTICS

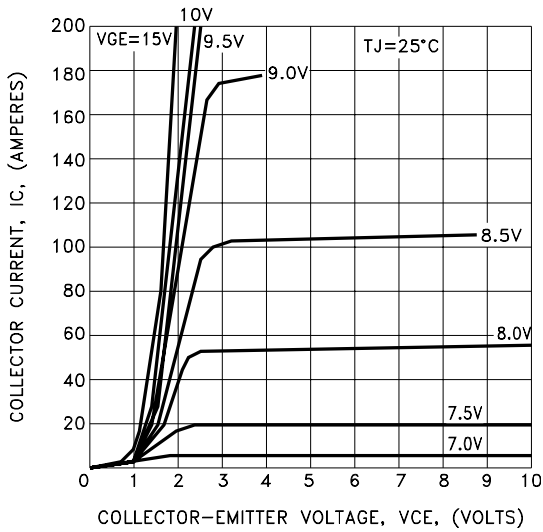

COLLECTOR-EMITTER SATURATION VOLTAGE CHARACTERISTICS

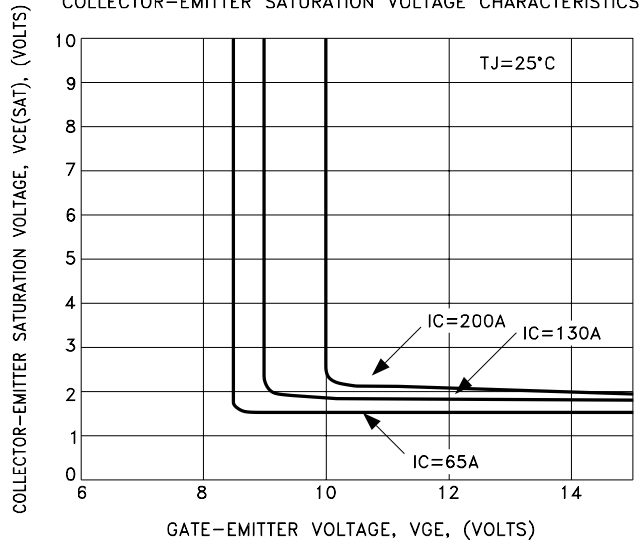

FREE-WHEEL DIODE FORWARD CHARACTERISTICS

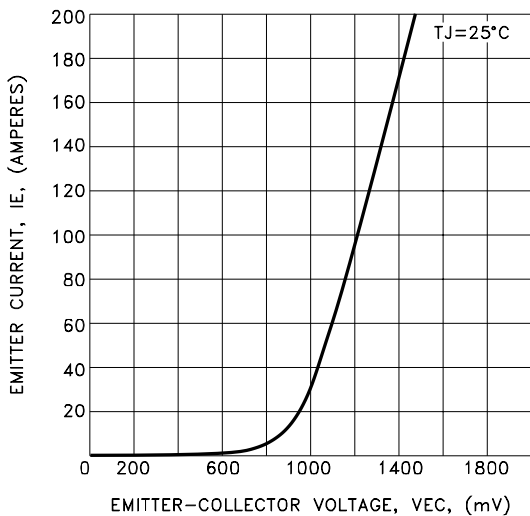

SWITCHING CHARACTERISTICS

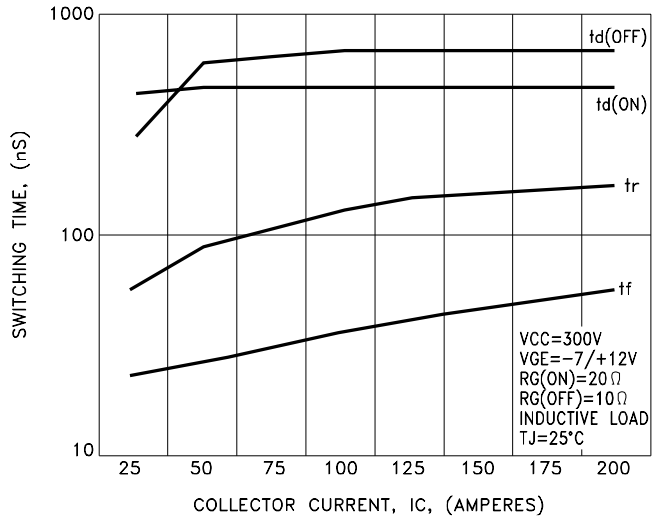

REVERSE RECOVERY CHARACTERISTICS

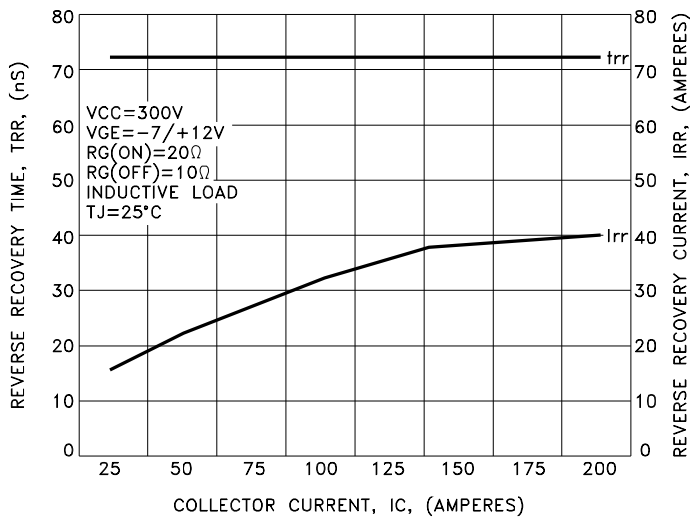

SWITCHING LOSS vs. COLLECTOR CURRENT

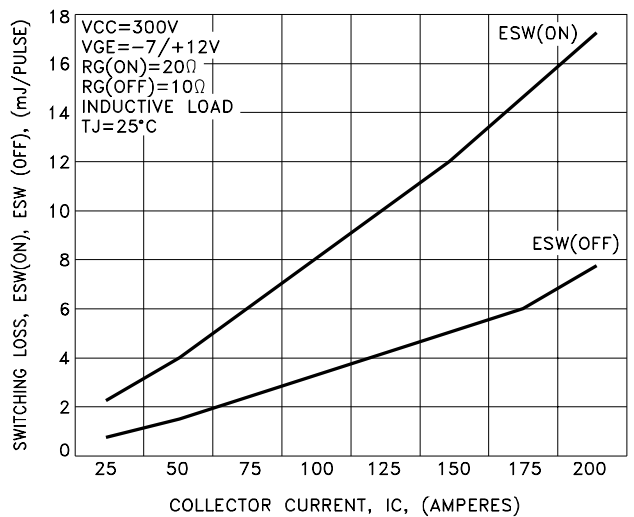

SCREENING CHART

OPERATION IN ACCORDANCE WITH MIL-PRF-38534	INDUSTRIAL	CLASS E	CLASS H
QUALIFICATION (MODIFIED)	NO	NO	YES
ELEMENT EVALUATION	NO	YES	YES
CLEAN ROOM PROCESSING	YES	YES	YES
NON DESTRUCT BOND PULL SAMPLE	YES	YES	YES
CERTIFIED OPERATORS	NO	YES	YES
MIL LINE PROCESSING	YES	YES	YES
MAX REWORK SPECIFIED	NO	YES	YES
ENCAPSULANT	GEL COAT	SEES™	SEES™
PRE-CAP VISUAL	YES - INDUSTRIAL	YES - CLASS H	YES - CLASS H
TEMP CYCLE (-55°C TO +125°C)	NO	YES	YES
BURN-IN	NO	YES - 96 HOURS	YES - 160 HOURS
ELECTRICAL TESTING	YES - 25°C	YES - 25°C	YES - FULL TEMP
EXTERNAL VISUAL	YES - SAMPLE	YES - SAMPLE	YES
XRAY	NO	NO	NO
PIN FINISH	NI	NI	NI

NOTE: ADDITIONAL SCREENING IS AVAILABLE SUCH AS XRAY, CSAM, MECHANICAL SHOCK, ETC.
CONTACT FACTORY FOR QUAL STATUS.

MECHANICAL SPECIFICATIONS

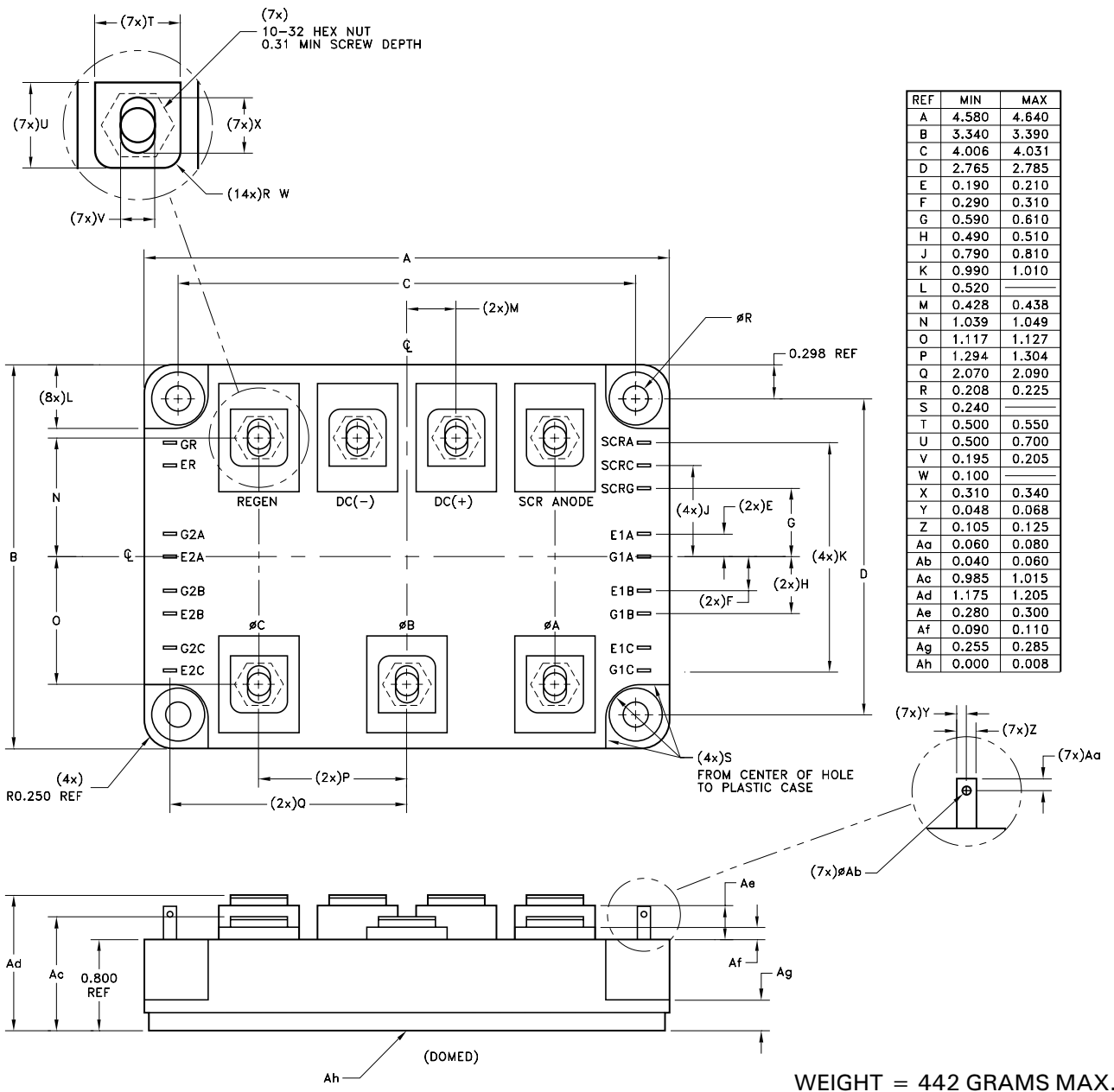

ORDERING INFORMATION

MSK4851 H

SCREENING

BLANK = INDUSTRIAL; E = EXTENDED RELIABILITY;
 H = MIL-PRF-38534 CLASS H (MODIFIED)

GENERAL PART NUMBER

THE ABOVE EXAMPLE IS A MILITARY SCREENED MODULE.

M.S. Kennedy Corp.

4707 Dey Road Liverpool, New York 13088

Phone (315) 701-6751

FAX (315) 701-6752

www.mskennedy.com

The information contained herein is believed to be accurate at the time of printing. MSK reserves the right to make changes to its products or specifications without notice, however, and assumes no liability for the use of its products. Please visit our website for the most recent revision of this datasheet.