

1.8" Bi-Color Single Digit Display

FEATURES

- 1.8" digit height
- Right hand decimal point
- Grey surface/white epoxy color

OPTO-ELECTRICAL CHARACTERISTICS (Ta = 25°C)

PART NO.	EMITTED COLOR	PEAK WAVE LENGTH (nm)	MAXIMUM RATINGS			OPTO-ELECTRICAL CHARACTERISTICS								PIN-OUT
			IF (mA)	VR (V)	PD (mW)	VF(V)			IR(μA)		IV(μcd)			
						seg. typ.	DP typ.	@mA	max.	@VR	typ. per seg.	@mA		
MTN6118-ARG	(R)	Red	700	30	5	85	6.3	2.1	20	100	5	1200	10	1
	(G)	Green	567	30	5	85	6.3	2.1	20	100	5	4600	10	1
MTN6118-AHRG	(HR)	Hi-Eff Red	635	30	5	85	6.3	2.1	20	100	5	5200	10	1
	(G)	Green	567	30	5	85	6.3	2.1	20	100	5	4600	10	1
MTN6118-CRG	(R)	Red	700	30	5	85	6.3	2.1	20	100	5	1200	10	2
	(G)	Green	567	30	5	85	6.3	2.1	20	100	5	4600	10	2
MTN6118-CHRG	(HR)	Hi-Eff Red	635	30	5	85	6.3	2.1	20	100	5	5200	10	2
	(G)	Green	567	30	5	85	6.3	2.1	20	100	5	4600	10	2

Operating Temperature: -25~+85, Storage Temperature: -25~+100. Other face/epoxy colors are available.

PACKAGE DIMENSIONS AND PIN FUNCTIONS

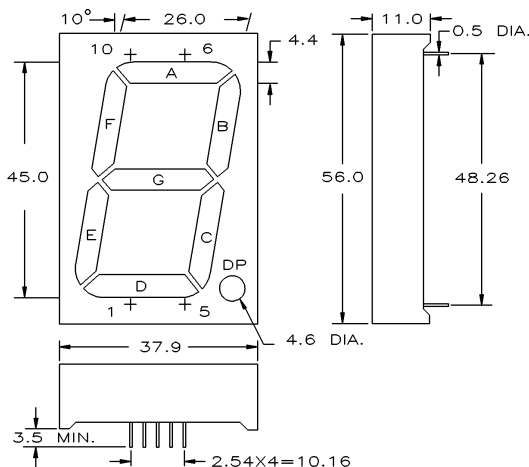

PINOUT 1

COMMON ANODE	
PIN NO.	FUNCTION
1.	COMMON ANODE (HR OR RED)
2.	CATHODE E
3.	CATHODE D
4.	CATHODE C
5.	COMMON ANODE (GREEN)
6.	CATHODE B
7.	CATHODE A
8.	CATHODE DP
9.	CATHODE F
10.	CATHODE G

PINOUT 2

COMMON CATHODE	
PIN NO.	FUNCTION
1.	COMMON CATHODE (HR OR RED)
2.	ANODE E
3.	ANODE D
4.	ANODE C
5.	COMMON CATHODE (GREEN)
6.	ANODE B
7.	ANODE A
8.	ANODE DP
9.	ANODE F
10.	ANODE G

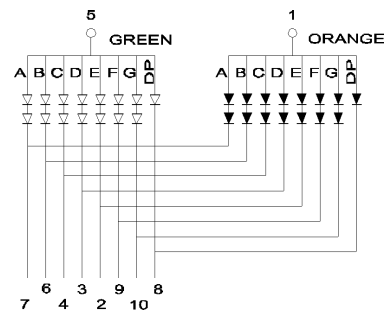

1. ALL DIMENSIONS ARE IN mm, TOLERANCE IS ± 0.25 mm UNLESS OTHERWISE SPECIFIED.
2. THE SLOPE ANGLE OF ANY PIN MAY BE $\pm 5.0^\circ$ MAX.



120 Broadway • Menands, New York 12204
Toll Free: (800) 98-4LEDS • Fax: (518) 432-7454

For up-to-date product info visit our web site at www.marktechopto.com

All specifications subject to change.