

# Bias Resistor Transistor

## PNP Silicon Surface Mount Transistor with Monolithic Bias Resistor Network

This new series of digital transistors is designed to replace a single device and its external resistor bias network. The BRT (Bias Resistor Transistor) contains a single transistor with a monolithic bias network consisting of two resistors; a series base resistor and a base-emitter resistor. The BRT eliminates these individual components by integrating them into a single device. The use of a BRT can reduce both system cost and board space. The device is housed in the SC-70/SOT-323 package which is designed for low power surface mount applications.

- Simplifies Circuit Design
- Reduces Board Space
- Reduces Component Count
- The SC-70/SOT-323 package can be soldered using wave or reflow. The modified gull-winged leads absorb thermal stress during soldering eliminating the possibility of damage to the die.
- Available in 8 mm embossed tape and reel  
Use the Device Number to order the 7 inch/3000 unit reel.  
Replace "T1" with "T3" in the Device Number to order the 13 inch/10,000 unit reel.

**MUN5111T1  
SERIES**

**PNP SILICON  
BIAS RESISTOR  
TRANSISTORS**

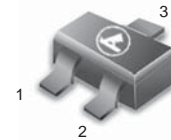

**CASE 419, STYLE 3  
SOT-323 (SC-70)**

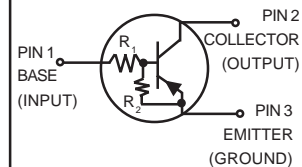

### MARKING DIAGRAM

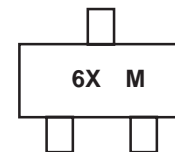

6X = Specific Device Code  
X = (See Marking Table)  
M = Date Code

### DEVICE MARKING INFORMATION

See specific marking information in the device marking table on page 2 of this data sheet.

### MAXIMUM RATINGS (T<sub>A</sub> = 25°C unless otherwise noted)

Rating	Symbol	Value	Unit
Collector-Base Voltage	V <sub>CBO</sub>	50	Vdc
Collector-Emitter Voltage	V <sub>CEO</sub>	50	Vdc
Collector Current	I <sub>c</sub>	100	mAdc

### THERMAL CHARACTERISTICS

Characteristic	Symbol	Max	Unit
Total Device Dissipation	P <sub>d</sub>	202 (Note 1)	mW
T <sub>A</sub> = 25°C		310 (Note 2)	
Derate above 25°C		1.6 (Note 1)	°C/W
		2.5 (Note 2)	
Thermal Resistance – Junction-to-Ambient	R <sub>θJA</sub>	618 (Note 1)	°C/W
Thermal Resistance – Junction-to-Lead	R <sub>θJL</sub>	280 (Note 1)	°C/W
		332 (Note 2)	
Junction and Storage Temperature Range	T <sub>J</sub> , T <sub>stg</sub>	-55 to +150	°C

1. FR-4 @ Minimum Pad

2. FR-4 @ 1.0 x 1.0 inch Pad

**MUN5111T1 SERIES****DEVICE MARKING AND RESISTOR VALUES**

Device	Package	Marking	R1 (K)	R2 (K)	Shipping
MUN5111T1	SC-70/SOT-323	6A	10	10	3000/Tape & Reel
MUN5112T1	SC-70/SOT-323	6B	22	22	3000/Tape & Reel
MUN5113T1 MUN5113T3	SC-70/SOT-323	6C	47	47	3000/Tape & Reel 10,000/Tape & Reel
MUN5114T1	SC-70/SOT-323	6D	10	47	3000/Tape & Reel
MUN5115T1 (Note 3)	SC-70/SOT-323	6E	10	∞	3000/Tape & Reel
MUN5116T1 (Note 3)	SC-70/SOT-323	6F	4.7	∞	3000/Tape & Reel
MUN5130T1 (Note 3)	SC-70/SOT-323	6G	1.0	1.0	3000/Tape & Reel
MUN5131T1 (Note 3)	SC-70/SOT-323	6H	2.2	2.2	3000/Tape & Reel
MUN5132T1 (Note 3)	SC-70/SOT-323	6J	4.7	4.7	3000/Tape & Reel
MUN5133T1 (Note 3)	SC-70/SOT-323	6K	4.7	47	3000/Tape & Reel
MUN5134T1 (Note 3)	SC-70/SOT-323	6L	22	47	3000/Tape & Reel
MUN5135T1 (Note 3)	SC-70/SOT-323	6M	2.2	47	3000/Tape & Reel
MUN5136T1	SC-70/SOT-323	6N	100	100	3000/Tape & Reel
MUN5137T1	SC-70/SOT-323	6P	47	22	3000/Tape & Reel

3. New devices. Updated curves to follow in subsequent data sheets.

**MUN5111T1 SERIES**

**ELECTRICAL CHARACTERISTICS** ( $T_A = 25^\circ\text{C}$  unless otherwise noted)

Characteristic	Symbol	Min	Typ	Max	Unit
<b>OFF CHARACTERISTICS</b>					
Collector–Base Cutoff Current ( $V_{CB} = 50\text{ V}, I_E = 0$ )	$I_{CBO}$	–	–	100	nAdc
Collector–Emitter Cutoff Current ( $V_{CE} = 50\text{ V}, I_B = 0$ )	$I_{CEO}$	–	–	500	nAdc
Emitter–Base Cutoff Current ( $V_{EB} = 6.0\text{ V}, I_C = 0$ )	$I_{EBO}$	–	–	0.5	mAdc
MUN5111T1		–	–	0.2	
MUN5112T1		–	–	0.1	
MUN5113T1		–	–	0.2	
MUN5114T1		–	–	0.9	
MUN5115T1		–	–	1.9	
MUN5116T1		–	–	4.3	
MUN5130T1		–	–	2.3	
MUN5131T1		–	–	1.5	
MUN5132T1		–	–	0.18	
MUN5133T1		–	–	0.13	
MUN5134T1		–	–	0.2	
MUN5135T1		–	–	0.05	
MUN5136T1		–	–	0.13	
MUN5137T1		–	–		
Collector–Base Breakdown Voltage ( $I_C = 10\ \mu\text{A}, I_E = 0$ )	$V_{(BR)CBO}$	50	–	–	Vdc
Collector–Emitter Breakdown Voltage (Note 4) ( $I_C = 2.0\text{ mA}, I_B = 0$ )	$V_{(BR)CEO}$	50	–	–	Vdc

**ON CHARACTERISTICS** (Note 4)

DC Current Gain ( $V_{CE} = 10\text{ V}, I_C = 5.0\text{ mA}$ )	$h_{FE}$	35	60	–	
MUN5111T1		60	100	–	
MUN5112T1		80	140	–	
MUN5113T1		80	140	–	
MUN5114T1		160	250	–	
MUN5115T1		160	250	–	
MUN5116T1		3.0	5.0	–	
MUN5130T1		8.0	15	–	
MUN5131T1		15	27	–	
MUN5132T1		80	140	–	
MUN5133T1		80	130	–	
MUN5134T1		80	140	–	
MUN5135T1		80	150	–	
MUN5136T1		80	140	–	
MUN5137T1		80	140	–	
Collector–Emitter Saturation Voltage ( $I_C = 10\text{ mA}, I_E = 0.3\text{ mA}$ ) ( $I_C = 10\text{ mA}, I_B = 5\text{ mA}$ ) MUN5130T1/MUN5131T1 ( $I_C = 10\text{ mA}, I_B = 1\text{ mA}$ ) MUN5115T1/MUN5116T1/ MUN5132T1/MUN5133T1/MUN5134T1	$V_{CE(sat)}$	–	–	0.25	Vdc
Output Voltage (on) ( $V_{CC} = 5.0\text{ V}, V_B = 2.5\text{ V}, R_L = 1.0\text{ k}\Omega$ )	$V_{OL}$	–	–	0.2	Vdc
MUN5111T1		–	–	0.2	
MUN5112T1		–	–	0.2	
MUN5114T1		–	–	0.2	
MUN5115T1		–	–	0.2	
MUN5116T1		–	–	0.2	
MUN5130T1		–	–	0.2	
MUN5131T1		–	–	0.2	
MUN5132T1		–	–	0.2	
MUN5133T1		–	–	0.2	
MUN5134T1		–	–	0.2	
MUN5135T1		–	–	0.2	
( $V_{CC} = 5.0\text{ V}, V_B = 3.5\text{ V}, R_L = 1.0\text{ k}\Omega$ )		–	–	0.2	
( $V_{CC} = 5.0\text{ V}, V_B = 5.5\text{ V}, R_L = 1.0\text{ k}\Omega$ )		–	–	0.2	
( $V_{CC} = 5.0\text{ V}, V_B = 4.0\text{ V}, R_L = 1.0\text{ k}\Omega$ )		–	–	0.2	

4. Pulse Test: Pulse Width < 300  $\mu\text{s}$ , Duty Cycle < 2.0%

MUN5111T1 SERIES

ELECTRICAL CHARACTERISTICS (T<sub>A</sub> = 25°C unless otherwise noted) (Continued)

Characteristic	Symbol	Min	Typ	Max	Unit
Output Voltage (off) (V <sub>CC</sub> = 5.0 V, V <sub>B</sub> = 0.5 V, R <sub>L</sub> = 1.0 kΩ) (V <sub>CC</sub> = 5.0 V, V <sub>B</sub> = 0.050 V, R <sub>L</sub> = 1.0 kΩ) (V <sub>CC</sub> = 5.0 V, V <sub>B</sub> = 0.25 V, R <sub>L</sub> = 1.0 kΩ)	V <sub>OH</sub>	4.9	–	–	Vdc
Input Resistor	R <sub>1</sub>	7.0	10	13	kΩ
MUN5130T1		15.4	22	28.6	
MUN5112T1		32.9	47	61.1	
MUN5113T1		7.0	10	13	
MUN5114T1		7.0	10	13	
MUN5115T1		3.3	4.7	6.1	
MUN5116T1		0.7	1.0	1.3	
MUN5130T1		1.5	2.2	2.9	
MUN5131T1		3.3	4.7	6.1	
MUN5132T1		3.3	4.7	6.1	
MUN5133T1		15.4	22	28.6	
MUN5134T1		1.54	2.2	2.86	
MUN5135T1		70	100	130	
MUN5136T1		32.9	47	61.1	
MUN5137T1					
Resistor Ratio	R <sub>1</sub> /R <sub>2</sub>	0.8	1.0	1.2	
MUN5111T1/MUN5112T1/MUN5113T1/ MUN5136T1		0.17	0.21	0.25	
MUN5114T1		–	–	–	
MUN5115T1/MUN5116T1		0.8	1.0	1.2	
MUN5130T1/MUN5131T1/MUN5132T1		0.055	0.1	0.185	
MUN5133T1		0.38	0.47	0.56	
MUN5134T1		0.038	0.047	0.056	
MUN5135T1		1.7	2.1	2.6	
MUN5137T1					

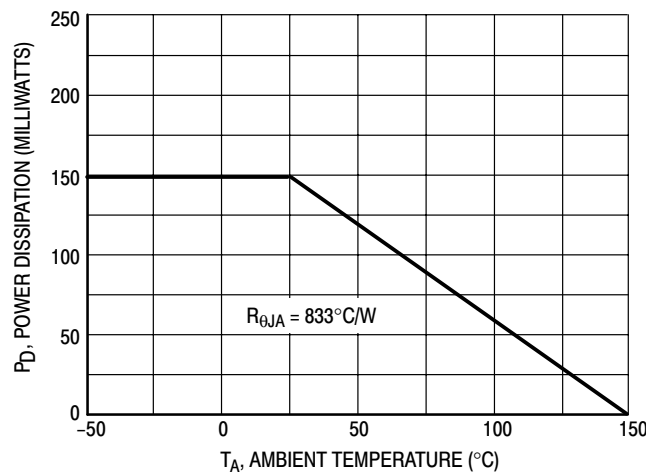

Figure 1. Derating Curve

MUN5111T1 SERIES

TYPICAL ELECTRICAL CHARACTERISTICS – MUN5111T1

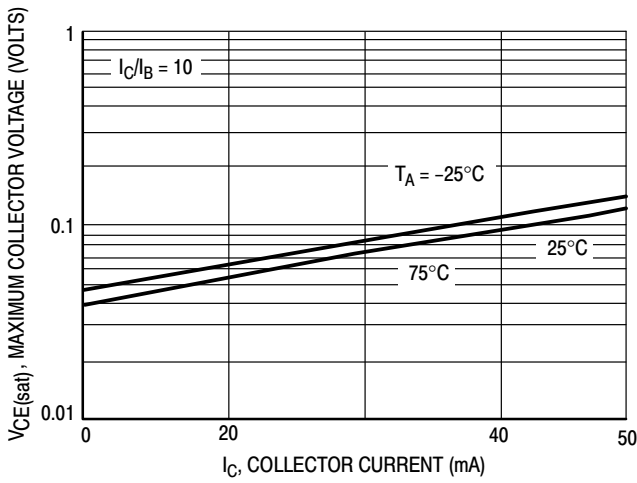

Figure 2.  $V_{CE(sat)}$  versus  $I_C$

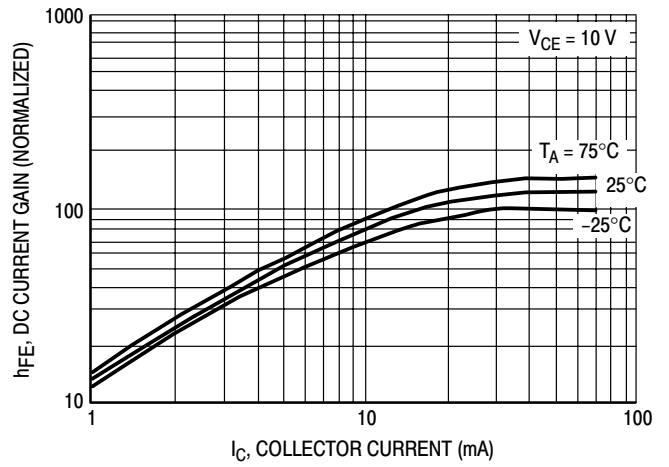

Figure 3. DC Current Gain

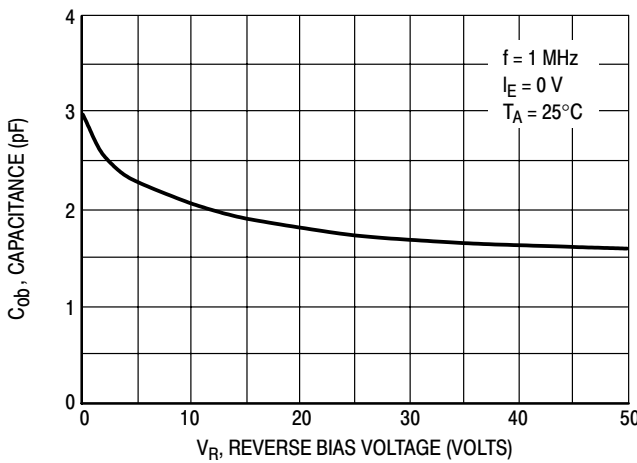

Figure 4. Output Capacitance

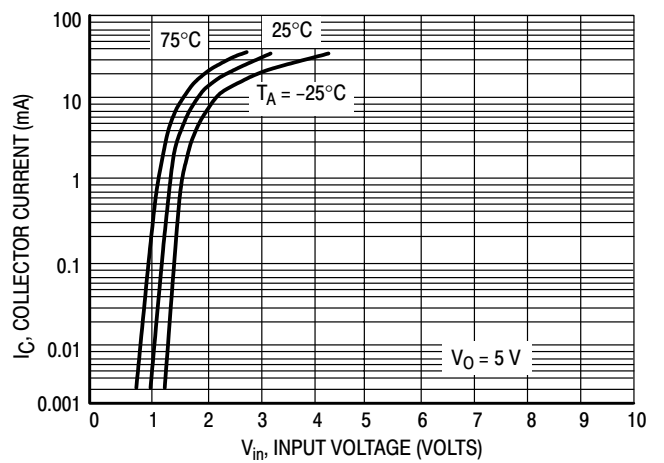

Figure 5. Output Current versus Input Voltage

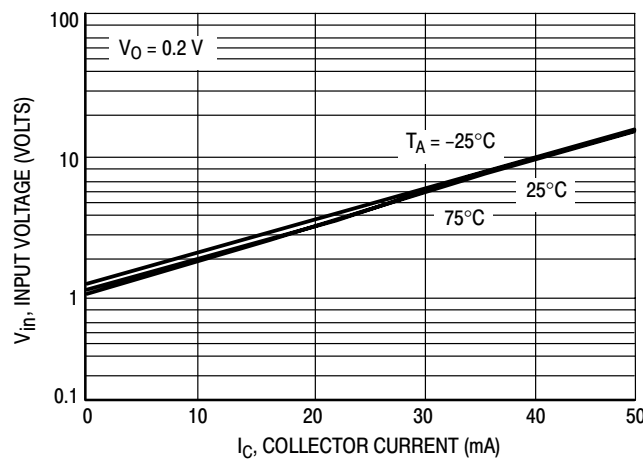

Figure 6. Input Voltage versus Output Current

MUN5111T1 SERIES

TYPICAL ELECTRICAL CHARACTERISTICS – MUN5112T1

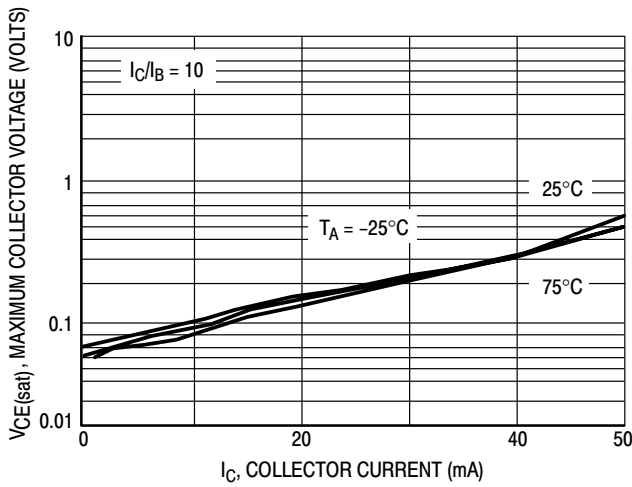

Figure 7.  $V_{CE(sat)}$  versus  $I_C$

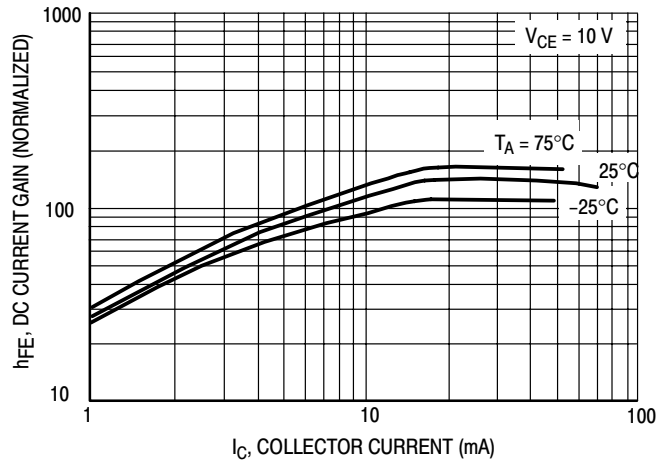

Figure 8. DC Current Gain

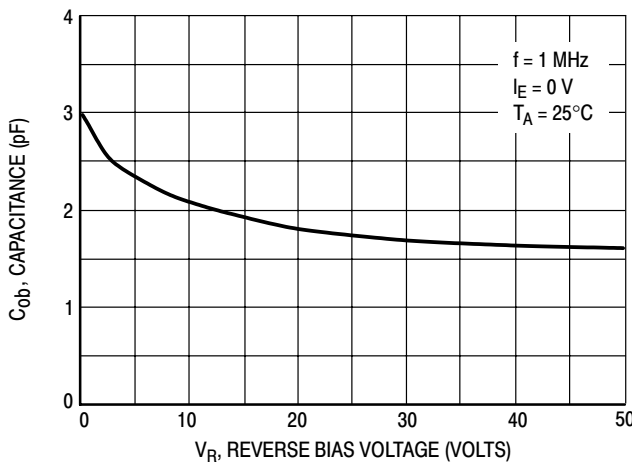

Figure 9. Output Capacitance

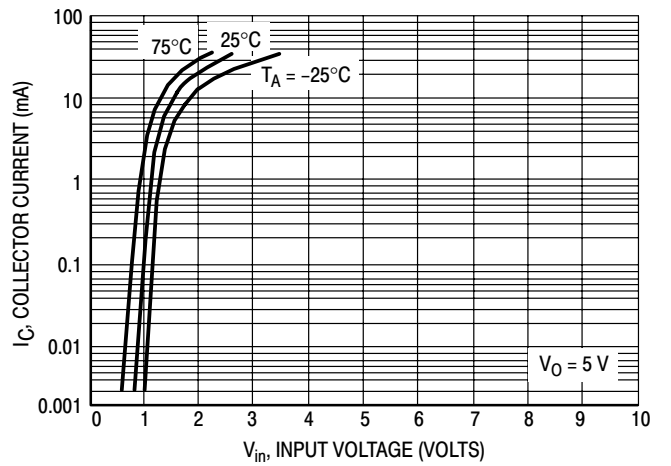

Figure 10. Output Current versus Input Voltage

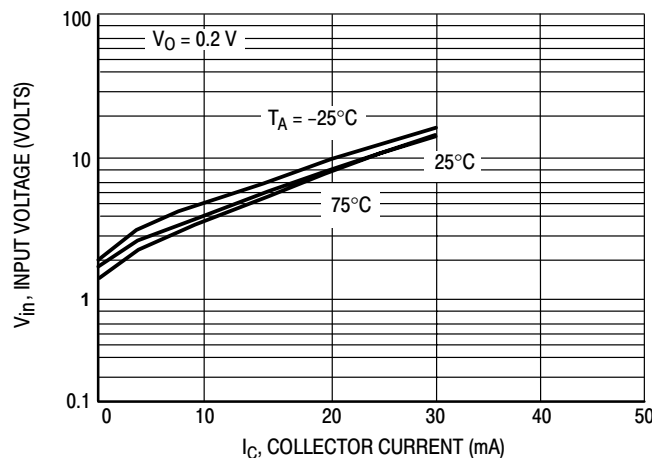

Figure 11. Input Voltage versus Output Current

MUN511T1 SERIES

TYPICAL ELECTRICAL CHARACTERISTICS – MUN5113T1

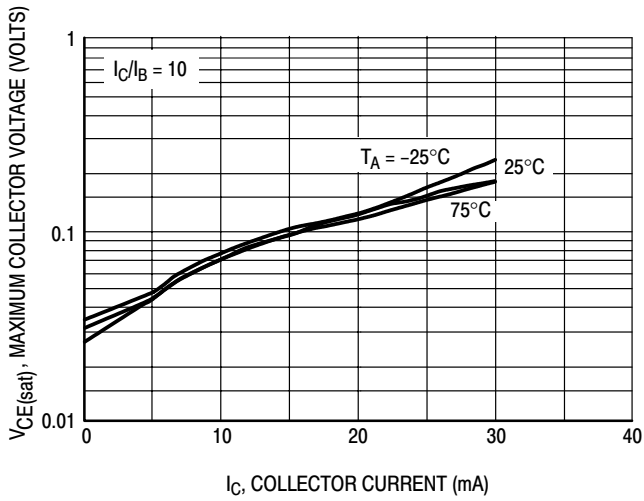

Figure 12.  $V_{CE(sat)}$  versus  $I_C$

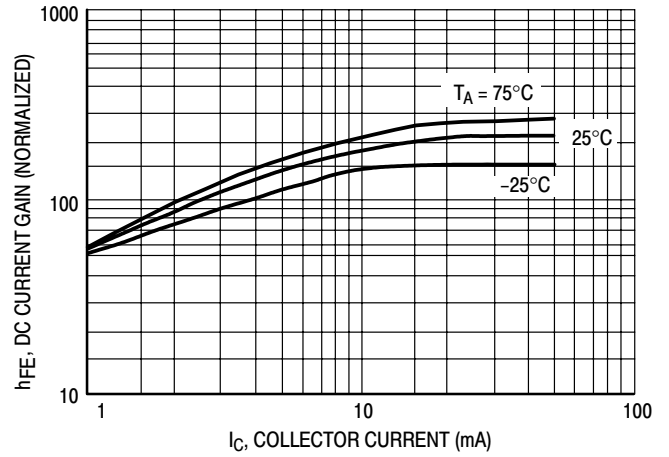

Figure 13. DC Current Gain

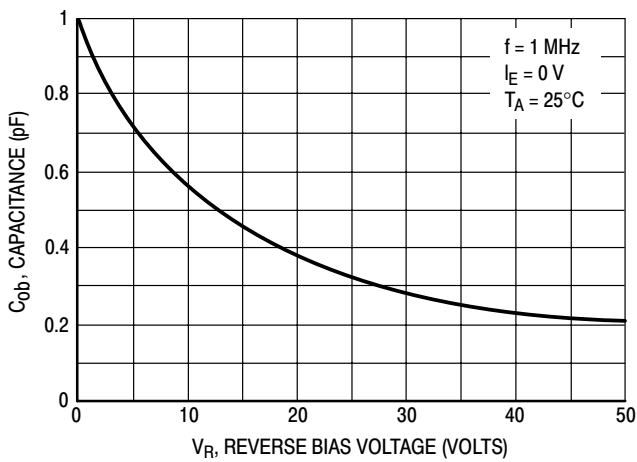

Figure 14. Output Capacitance

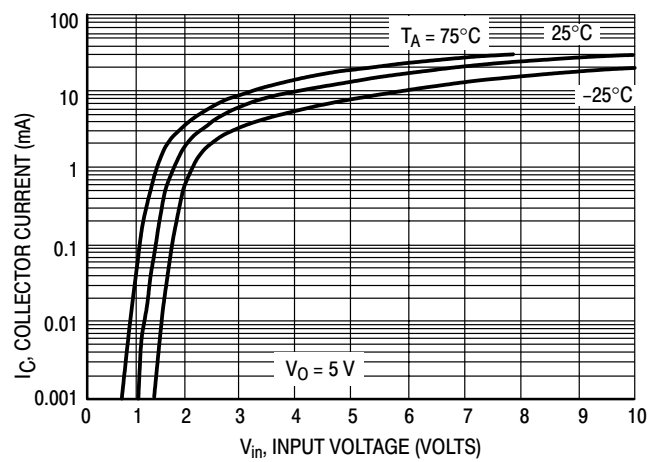

Figure 15. Output Current versus Input Voltage

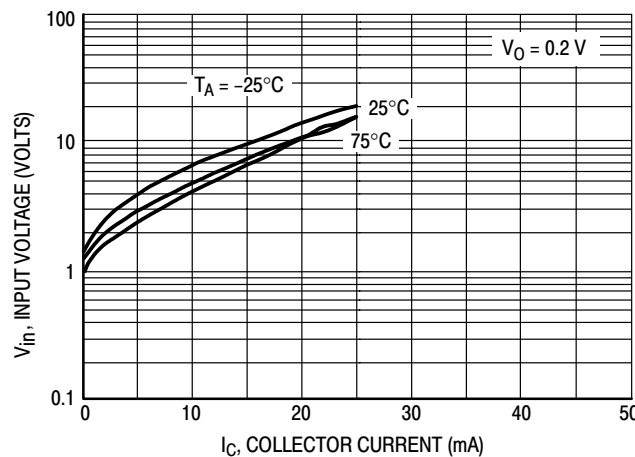

Figure 16. Input Voltage versus Output Current

MUN5111T1 SERIES

TYPICAL ELECTRICAL CHARACTERISTICS – MUN5114T1

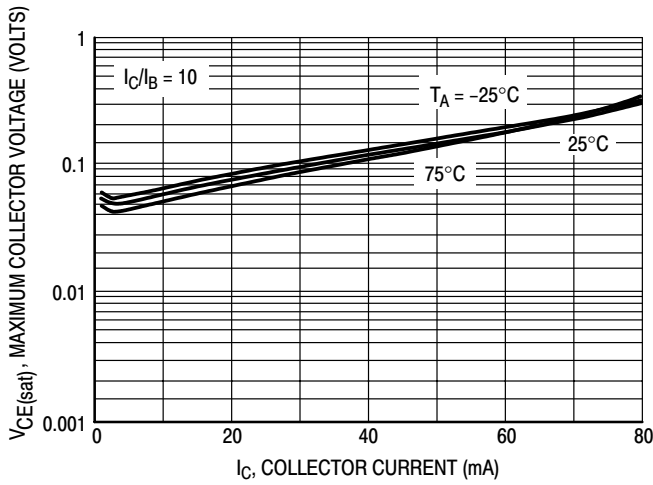

Figure 17.  $V_{CE(sat)}$  versus  $I_C$

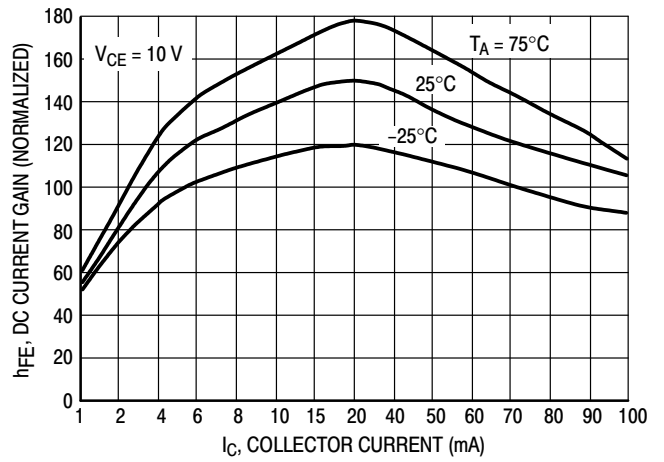

Figure 18. DC Current Gain

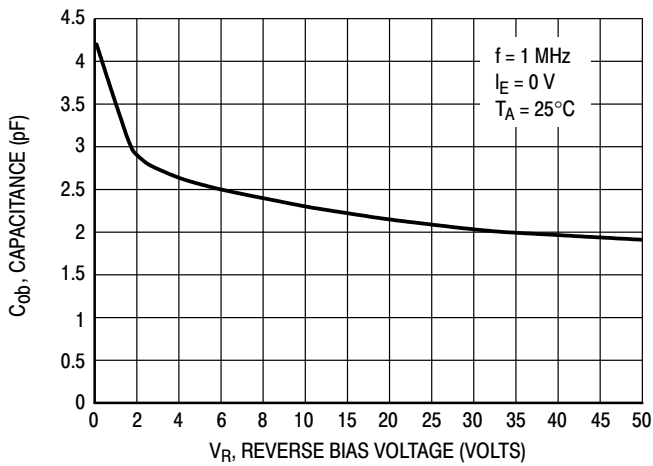

Figure 19. Output Capacitance

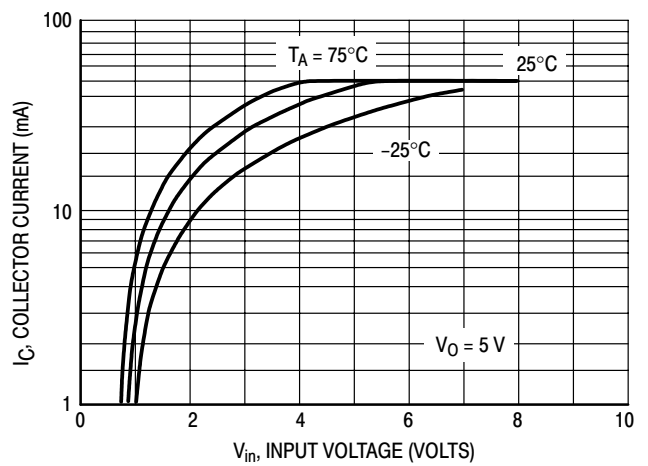

Figure 20. Output Current versus Input Voltage

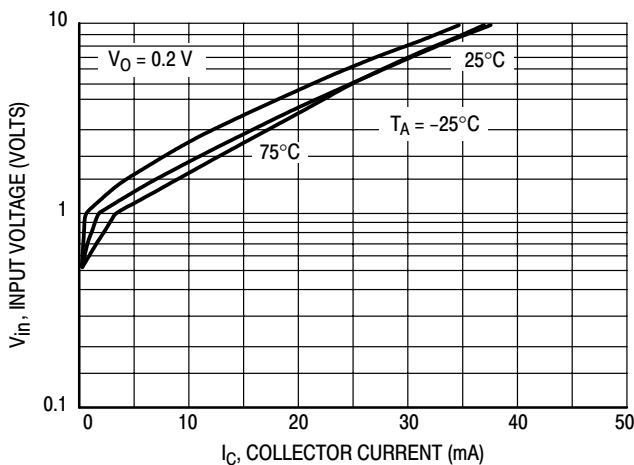

Figure 21. Input Voltage versus Output Current

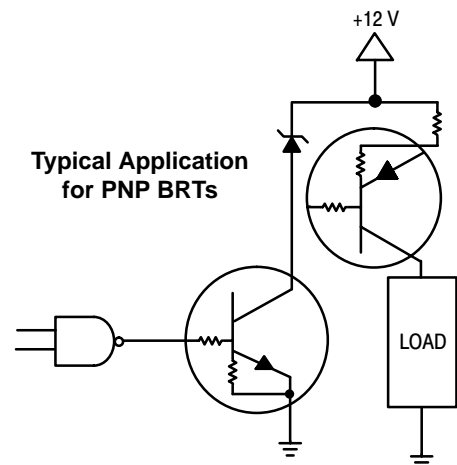

Figure 22. Inexpensive, Unregulated Current Source



MUN5111T1 SERIES

TYPICAL ELECTRICAL CHARACTERISTICS — MUN5132T1

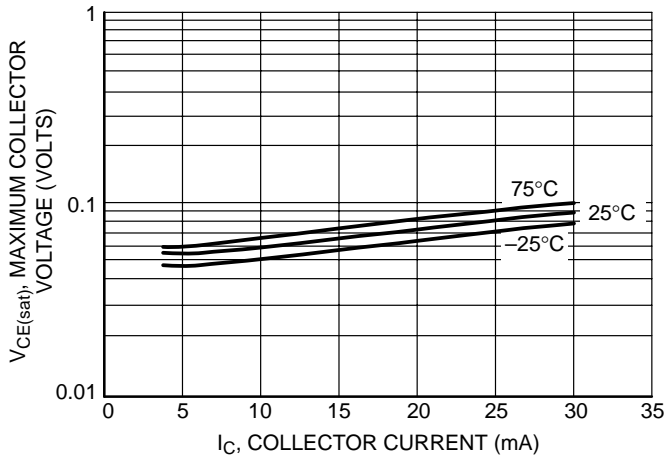

Figure 23. Maximum Collector Voltage versus Collector Current

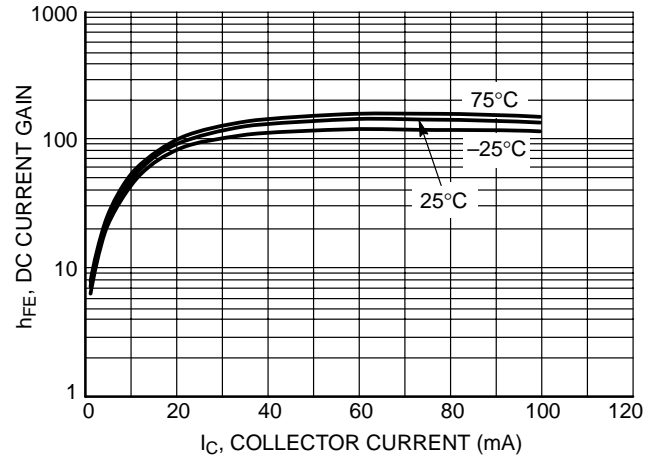

Figure 24. DC Current Gain

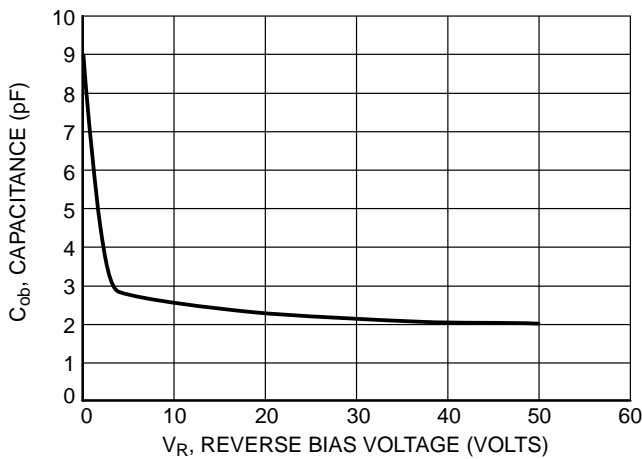

Figure 25. Output Capacitance

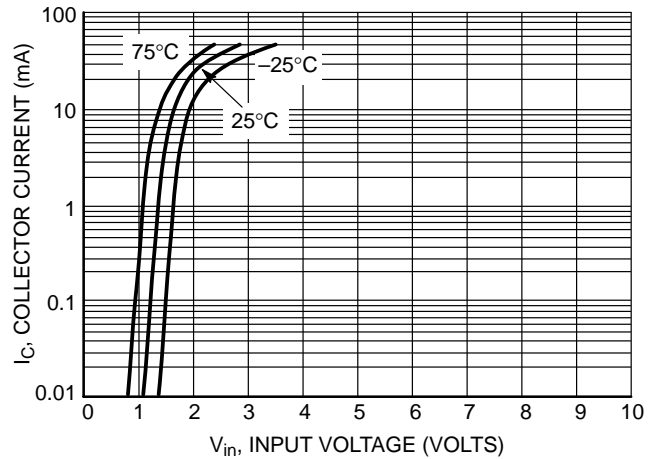

Figure 26. Output Current versus Input Voltage

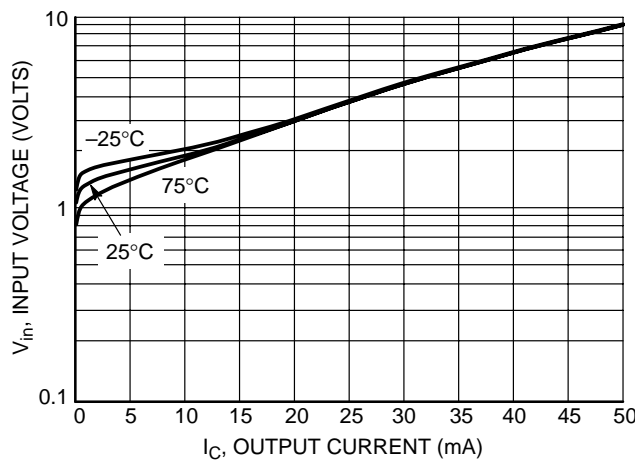

Figure 27. Input Voltage versus Output Current

MUN5111T1 SERIES

TYPICAL ELECTRICAL CHARACTERISTICS — MUN5136T1

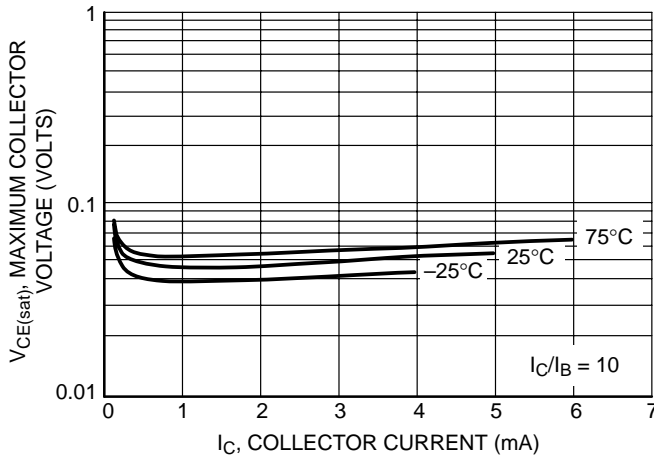

Figure 28. Maximum Collector Voltage versus Collector Current

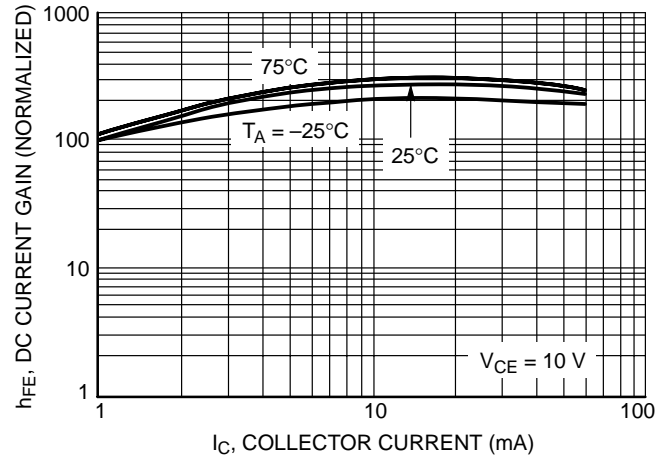

Figure 29. DC Current Gain

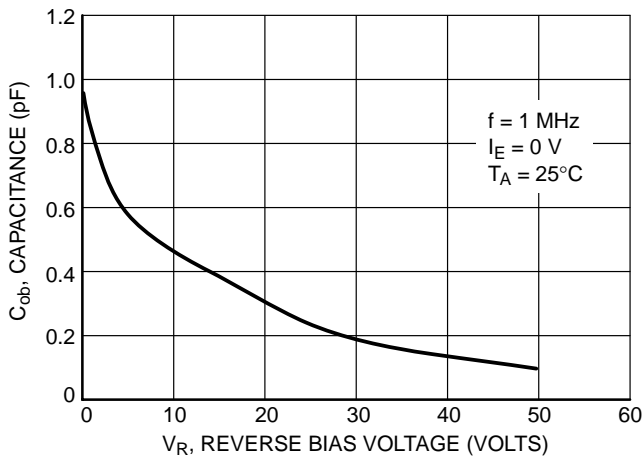

Figure 30. Output Capacitance

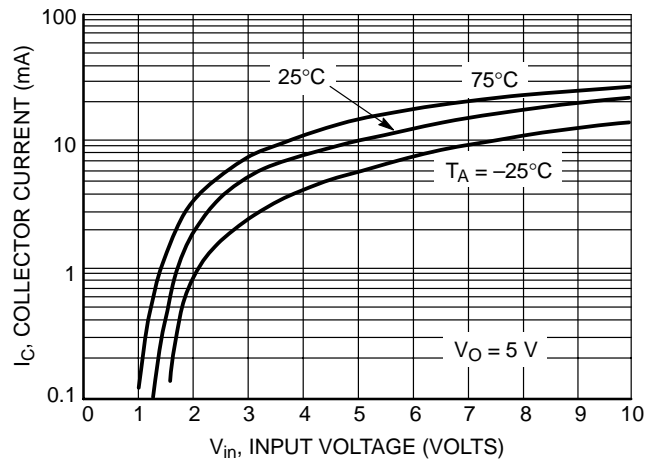

Figure 31. Output Current versus Input Voltage

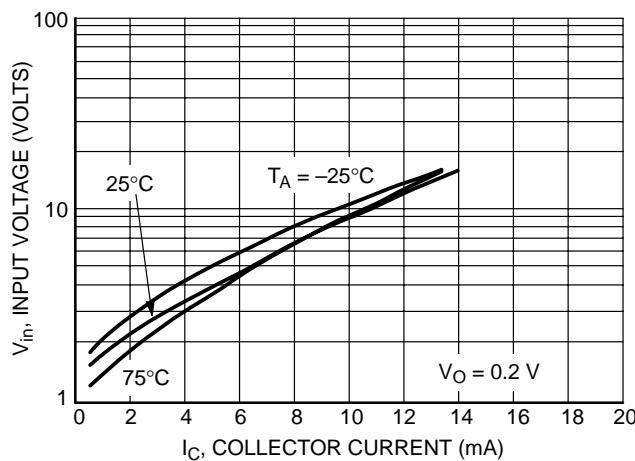

Figure 32. Input Voltage versus Output Current

MUN5111T1 SERIES

TYPICAL ELECTRICAL CHARACTERISTICS — MUN5137T1

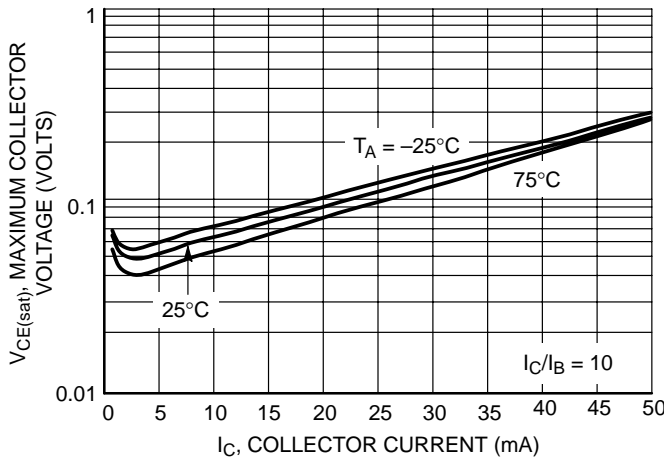

Figure 33. Maximum Collector Voltage versus Collector Current

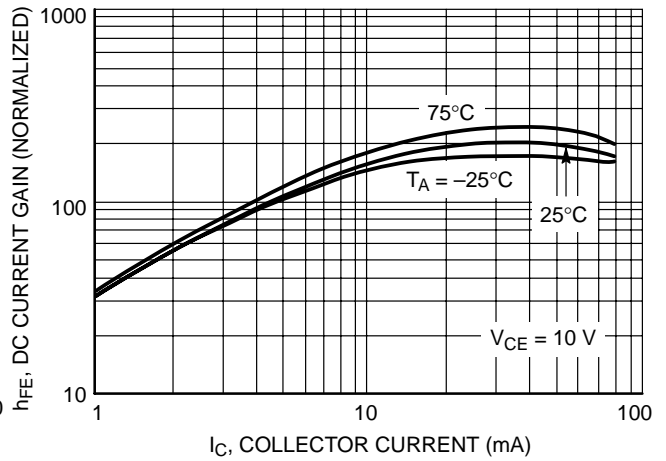

Figure 34. DC Current Gain

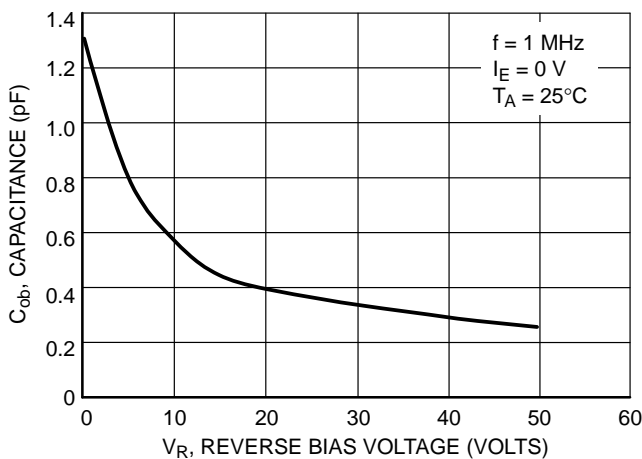

Figure 35. Output Capacitance

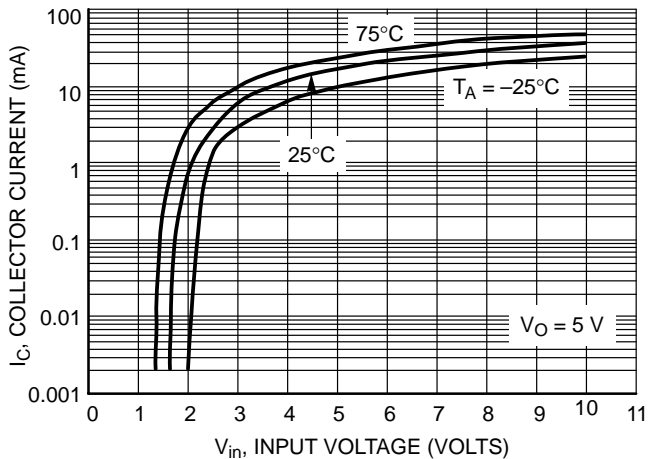

Figure 36. Output Current versus Input Voltage

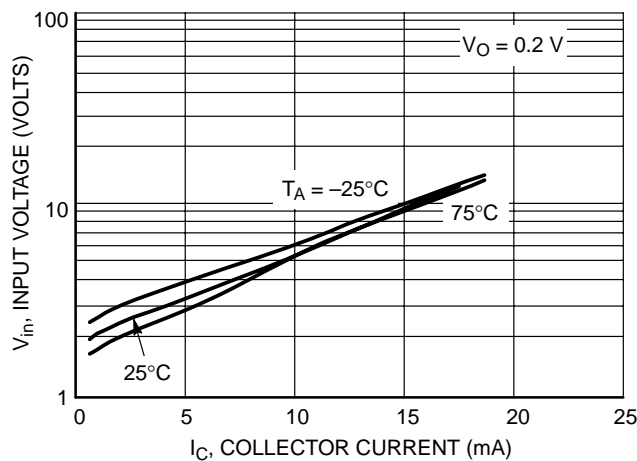

Figure 37. Input Voltage versus Output Current